

Versão: 06 de Março 2024



CATÁLOGO DE  
**PRODUTOS**  
EM  
**LIQUIDAÇÃO**

\*O Catálogo de liquidação é atualizado constantemente.  
Antes de baixar, verifique a versão com data atualizada.



# ABASTEÇA SEU ESTOQUE



**TSW**



# PRODUTOS EM LIQUIDAÇÃO



## TSW



1



3



5



7



4



6



### CAPACETE MTB LED | RAPTOR II

#### CARACTERÍSTICA

In Mold | Regulável c/ viseira e led | 18 canais de ventilação, tela anti-inseto, Sistema de engate em "Y"

#### PESO APROXIMADO

223g

#### EMBALAGEM

18 peças

#### TAMANHO MÉDIO - 54 À 58

1		-
3		-
4		11850
5		-
6		11853
7		-

#### TAMANHO GRANDE - 57 À 61

1		-
2		-
3		11838
4		-
6		-
7		11839

FOTOS MERAMENTE ILUSTRATIVAS. AS INFORMAÇÕES/CONFIGURAÇÕES DE PRODUTOS PODERÃO SOFRER ALTERAÇÕES SEM AVISO PRÉVIO.

ENTRE EM CONTATO COM O SEU CONSULTOR OU FALE COM O NOSSO TIME DE TELEVENDAS PELO (33) 3277-3030.



# PRODUTOS EM LIQUIDAÇÃO



## TSW



1



2



3



4



5



7



### CAPACETE MTB LED | RAPTOR III

**CARACTERÍSTICA** In Mold | Regulável | Viseira | Led ( 3 modos) | 18 canais de ventilação | Tela anti-inseto | Sistema de engate em "Y"

**PESO APROXIMADO** 223g

**EMBALAGEM** 18 peças

TAMANHO MÉDIO - 54 À 58

1		16046
2		16047
3		16048
4		16051
5		16052
7		16055

TAMANHO GRANDE - 57 À 61

3		-
4		16042
5		-
6		-
7		-

FOTOS MERAMENTE ILUSTRATIVAS. AS INFORMAÇÕES/CONFIGURAÇÕES DE PRODUTOS PODERÃO SOFRER ALTERAÇÕES SEM AVISO PRÉVIO.

ENTRE EM CONTATO COM O SEU CONSULTOR OU FALE COM O NOSSO TIME DE TELEVENDAS PELO (33) 3277-3030.



# PRODUTOS EM LIQUIDAÇÃO



## TSW



### CAPACETE TEAM | PLUS

**CARACTERÍSTICA** In Mold | Regulável 17 canais de ventilação | Sistema de engate em "Y" | espuma removível e lavável | Faixa refletiva na carneira

**PESO APROXIMADO** 264g

**EMBALAGEM** 10 peças

TAMANHO GRANDE - 57 À 61

1  13572



FOTOS MERAMENTE ILUSTRATIVAS. AS INFORMAÇÕES/CONFIGURAÇÕES DE PRODUTOS PODERÃO SOFRER ALTERAÇÕES SEM AVISO PRÉVIO.

ENTRE EM CONTATO COM O SEU CONSULTOR OU FALE COM O NOSSO TIME DE TELEVENDAS PELO (33) 3277-3030.



# PRODUTOS EM LIQUIDAÇÃO



## TSW

1



2



3



4



### CAPACETE MTB | ENDURO 2021/2022

<b>CARACTERÍSTICAS</b>	16 canais de ventilação, Sistema de engate em Y, prático e de fácil ajuste espuma removível e lavável   Viseira   In Mold
<b>TAMANHO</b>	Único   Regulável 58-61 M/L
<b>PESO</b>	268g
<b>EMBALAGEM</b>	12 peças

#### TAMANHO ÚNICO - 58 À 61

1		16061
2		16059
3		-
4		16057

FOTOS MERAMENTE ILUSTRATIVAS. AS INFORMAÇÕES/CONFIGURAÇÕES DE PRODUTOS PODERÃO SOFRER ALTERAÇÕES SEM AVISO PRÉVIO.

ENTRE EM CONTATO COM O SEU CONSULTOR OU FALE COM O NOSSO TIME DE TELEVENDAS PELO (33) 3277-3030.



# PRODUTOS EM LIQUIDAÇÃO



## TSW

2



3



4



5



### CARNEIRA PLÁSTICA para capacete

CARACTERÍSTICA	Para ajuste de capacete
MATERIAL	Nylon
EMBALAGEM	10 peças

2 TUNE 10164

4 PRO RACE 03853

3 ENDURO 11135

5 PLUS TSW/  
MITSU 03853

### CARNEIRA PLÁSTICA para capacete TEAM RACE

CARACTERÍSTICA	Para ajuste de capacete
MATERIAL	Nylon
EMBALAGEM	50 peças
PESO	21 gramas

19063

FOTOS MERAMENTE ILUSTRATIVAS. AS INFORMAÇÕES/CONFIGURAÇÕES DE PRODUTOS PODERÃO SOFRER ALTERAÇÕES SEM AVISO PRÉVIO.

ENTRE EM CONTATO COM O SEU CONSULTOR OU FALE COM O NOSSO TIME DE TELEVENDAS PELO (33) 3277-3030.



# PRODUTOS EM LIQUIDAÇÃO



## TSW



1



2



3



4



5



8



### LUVA MTB DM FLEX | Modelo 02

**INTERNO** Microfibra | sbr | Pontos siliconados

**EXTERNO** Tecido elástico | Velcro

**EMBALAGEM** 10 peças

P	M	G
1  -	4  12517	2  12511
2  -		

FOTOS MERAMENTE ILUSTRATIVAS. AS INFORMAÇÕES/CONFIGURAÇÕES DE PRODUTOS PODERÃO SOFRER ALTERAÇÕES SEM AVISO PRÉVIO.

ENTRE EM CONTATO COM O SEU CONSULTOR OU FALE COM O NOSSO TIME DE TELEVENDAS PELO (33) 3277-3030.





# PRODUTOS EM LIQUIDAÇÃO



## TSW













### LUVA MTB DM DUAL | Modelo 02

**INTERNO** Microfibrã | Tecido elástico

**EXTERNO** Tecido elástico | Velcro

**EMBALAGEM** 10 peças

P	M	G	GG
1  12554	1  -	4  -	4  12531
6  12555	2  12546	6  12539	
	3  -		
	4  12547		
	6  12549		

FOTOS MERAMENTE ILUSTRATIVAS. AS INFORMAÇÕES/CONFIGURAÇÕES DE PRODUTOS PODERÃO SOFRER ALTERAÇÕES SEM AVISO PRÉVIO.

ENTRE EM CONTATO COM O SEU CONSULTOR OU FALE COM O NOSSO TIME DE TELEVENDAS PELO (33) 3277-3030.

# PRODUTOS EM LIQUIDAÇÃO

## TSW



### CAMISA RIDE LINE

**CARACTERÍSTICA** Corpo: 100% microfilamento de poliéster | Mangas e Cintura: Microfilamento de poliéster + elastano e silicone | Bolso: 2 bolsos atrás e um extra com zíper | Zíper: longo frontal

**PROTEÇÃO** UV-30

**MATERIAL** 100% microfilamento poliéster

**EMBALAGEM** 1 peça

P  20988

M  -

G  -

P  -

M  -

G  -

P  -

M  -

G  -

P  21001

M  21002

G  21003

GG  -

FOTOS MERAMENTE ILUSTRATIVAS. AS INFORMAÇÕES/CONFIGURAÇÕES DE PRODUTOS PODERÃO SOFRER ALTERAÇÕES SEM AVISO PRÉVIO.

ENTRE EM CONTATO COM O SEU CONSULTOR OU FALE COM O NOSSO TIME DE TELEVENDAS PELO (33) 3277-3030.



# PRODUTOS EM LIQUIDAÇÃO



## TSW



### CAMISA RIDE LINE

#### CARACTERÍSTICA

Camisa de ciclismo estruturada, ideal para quem procura conforto e estilo em uma modelagem perfeita. Tecido de alta qualidade. Elástico na borda inferior da camisa para uma melhor fixação. Gola redonda com fechamento em zíper | Manga curta

Bolsos: 2 Bolsos traseiros para acondicionar utensílios

Zíper: Zíper com Smart Lock (controle de trava do zíper) fornecendo assim controle da abertura e ventilação

#### MATERIAL

100% poliéster

#### PROTEÇÃO

UV 30

#### EMBALAGEM

1 peça

TAM.04 21654

TAM.06 21655

TAM.08 21656



### CAMISA RIDE LINE TSW

#### CARACTERÍSTICA

Tecido de alta qualidade | Laterais com textura microperfuradas permitindo a respiração da pele, permitindo assim uma e secagem rápida, sendo eficiente durante a transmissão de calor |

Manga: Curta com detalhes texturizados em sua extremidade

Bolsos: Traseiros triplos reforçados e bolso com zíper

Zíper: Frontal total com Smart Lock (controle de trava do zíper) fornecendo assim controle da abertura e ventilação

#### PROTEÇÃO

UV 50 nas mangas e UV 30 frente/costa

#### MATERIAL

100% poliéster

#### EMBALAGEM

1 peça



P	■	20984
M	■	-
G	■	-
GG	■	-

FOTOS MERAMENTE ILUSTRATIVAS. AS INFORMAÇÕES/CONFIGURAÇÕES DE PRODUTOS PODERÃO SOFRER ALTERAÇÕES SEM AVISO PRÉVIO.

ENTRE EM CONTATO COM O SEU CONSULTOR OU FALE COM O NOSSO TIME DE TELEVENDAS PELO (33) 3277-3030.



# PRODUTOS EM LIQUIDAÇÃO





## TSW



### CAMISA STORM manga longa para ciclismo | PRO LINE

<b>CARACTERÍSTICA</b>	Ajusta melhor ao corpo para um melhor desempenho
<b>PROTEÇÃO</b>	UV: 50   Ação Antibacteriana
<b>MANGAS E CINTURA</b>	Fita elástica siliconada (Cintura)
<b>BOLSO</b>	Traseiro
<b>ZÍPER</b>	Longo   Smart Lock (controle de trava do zíper)
<b>MATERIAL</b>	100% Poliéster
<b>EMBALAGEM</b>	1 peça

<b>P</b>	
1	 13540
2	 13506

FOTOS MERAMENTE ILUSTRATIVAS. AS INFORMAÇÕES/CONFIGURAÇÕES DE PRODUTOS PODERÃO SOFRER ALTERAÇÕES SEM AVISO PRÉVIO.

ENTRE EM CONTATO COM O SEU CONSULTOR OU FALE COM O NOSSO TIME DE TELEVENDAS PELO (33) 3277-3030.

# PRODUTOS EM LIQUIDAÇÃO

## TSW



### CAMISA SUNNY manga longa para ciclismo | RIDE LINE

CARACTERÍSTICA	Ajusta melhor ao corpo para um melhor desempenho
PROTEÇÃO	UV: 50   Ação Antibacteriana
MANGAS E CINTURA	Fita elástica siliconada (Cintura)
BOLSO	Traseiro
ZÍPER	Longo   Smart Lock (controle de trava do zíper)
MATERIAL	100% Poliéster
EMBALAGEM	1 peça

P	1	13544
	2	13548
	3	13553
	4	13557

M	3	13554
---	---	-------

G	3	13555
---	---	-------

GG	1	-
	3	-

FOTOS MERAMENTE ILUSTRATIVAS. AS INFORMAÇÕES/CONFIGURAÇÕES DE PRODUTOS PODERÃO SOFRER ALTERAÇÕES SEM AVISO PRÉVIO.

ENTRE EM CONTATO COM O SEU CONSULTOR OU FALE COM O NOSSO TIME DE TELEVENDAS PELO (33) 3277-3030.

PRODUTOS EM LIQUIDAÇÃO

TSW



### CAMISA ENDURENCE TSW MANGA LONGA

**CARACTERÍSTICA**

Camisa esportiva enduro | Tecido 100% poliéster e de alta qualidade, com ótimo desempenho térmico e punho com acabamento liso

Mangas e Cintura: Manga longa com punho liso e cintura lisa

**MATERIAL**

100% poliéster

**EMBALAGEM**

1 peça

P		-	P		21109
M		-	M		-
G		-	G		-
GG		21108	GG		-

FOTOS MERAMENTE ILUSTRATIVAS. AS INFORMAÇÕES/CONFIGURAÇÕES DE PRODUTOS PODERÃO SOFRER ALTERAÇÕES SEM AVISO PRÉVIO.

ENTRE EM CONTATO COM O SEU CONSULTOR OU FALE COM O NOSSO TIME DE TELEVENDAS PELO (33) 3277-3030.

# PRODUTOS EM LIQUIDAÇÃO

## TSW



P  19014  
M  -  
G  -



P  19017  
M  -  
G  -



### CAMISA ELITE TEAM RACE

**CARACTERÍSTICA** Modelagem Slim | Tecido com memória elástica | Fita elástica siliconada na cintura

**PROTEÇÃO** UV: 50+ | Ação Antibacteriana

**MANGAS E PERNAS** Mangas com acabamento Neo Cut (corte a laser)

**BOLSO** Traseiro

**ZÍPER** Longo | Smart Lock (controle de trava do zíper) | Puxador emborrachado

**MATERIAL** 84% Poliéster | 14% Elastano

**FORRO** Espuma D-80

**SKINFIT 3 TECIDOS** Combinação estratégica com diferentes tecidos de diferentes comportamentos, melhorando absorção de suor, flexibilidade e conforto

**EMBALAGEM** 10 peças

FOTOS MERAMENTE ILUSTRATIVAS. AS INFORMAÇÕES/CONFIGURAÇÕES DE PRODUTOS PODERÃO SOFRER ALTERAÇÕES SEM AVISO PRÉVIO.

ENTRE EM CONTATO COM O SEU CONSULTOR OU FALE COM O NOSSO TIME DE TELEVENDAS PELO (33) 3277-3030.



# PRODUTOS EM LIQUIDAÇÃO











## TSW



### CAMISA STORM para ciclismo | PRO LINE

<b>CARACTERÍSTICA</b>	Ajusta melhor ao corpo para um melhor desempenho.
<b>PROTEÇÃO</b>	UV: 50   Ação Antibacteriana
<b>MANGAS E CINTURA</b>	Fita elástica siliconada   Corte a laser (manga)
<b>BOLSO</b>	Traseiro
<b>ZÍPER</b>	Longo   Smart Lock (controle de trava do zíper)
<b>MATERIAL</b>	100% Poliéster
<b>EMBALAGEM</b>	1 peça

	P	M
1	 13427	 13428
2	 13421	 13422
	G	GG
1	 13432	 13433
2	 13425	 13426

FOTOS MERAMENTE ILUSTRATIVAS. AS INFORMAÇÕES/CONFIGURAÇÕES DE PRODUTOS PODERÃO SOFRER ALTERAÇÕES SEM AVISO PRÉVIO.

ENTRE EM CONTATO COM O SEU CONSULTOR OU FALE COM O NOSSO TIME DE TELEVENDAS PELO (33) 3277-3030.





# PRODUTOS EM LIQUIDAÇÃO



## TSW



1



2



3



4

### CAMISA SUNNY para ciclismo | RIDE LINE

CARACTERÍSTICA	Ajusta melhor ao corpo para um melhor desempenho.
PROTEÇÃO	UV: 50   Ação Antibacteriana
MANGAS E CINTURA	Fita elástica siliconada (Cintura)
BOLSO	Traseiro
ZÍPER	Longo   Smart Lock (controle de trava do zíper)
MATERIAL	100% Poliéster
EMBALAGEM	1 peça

P		M			
1		13435	1		13437
2		13442	2		13443
3		13450	3		13452
4		13457	4		13458
G		GG			
1		13439	1		13440
2		13445	2		13448
3		13453	3		13455
4		13460	4		13462

FOTOS MERAMENTE ILUSTRATIVAS. AS INFORMAÇÕES/CONFIGURAÇÕES DE PRODUTOS PODERÃO SOFRER ALTERAÇÕES SEM AVISO PRÉVIO.

ENTRE EM CONTATO COM O SEU CONSULTOR OU FALE COM O NOSSO TIME DE TELEVENDAS PELO (33) 3277-3030.

# PRODUTOS EM LIQUIDAÇÃO

## TSW



### CAMISA PRO LINE

- CARACTERÍSTICA** Microfilamento de poliéster + elastano com elástico reforçado com gel personalizado | Mangas e Cintura: gel interno | Bolso: traseiro com zíper | Zíper: full
- PROTEÇÃO** UV-50
- MATERIAL** Microfilamento de poliéster + elastano
- EMBALAGEM** 1 peça

P		-	G		-	M		-	P		-	P	<input type="checkbox"/>	-
G		-	G		-	G		-	M		-	M	<input type="checkbox"/>	-
						G		-	G	<input type="checkbox"/>	-	G	<input type="checkbox"/>	21062

FOTOS MERAMENTE ILUSTRATIVAS. AS INFORMAÇÕES/CONFIGURAÇÕES DE PRODUTOS PODERÃO SOFRER ALTERAÇÕES SEM AVISO PRÉVIO.

ENTRE EM CONTATO COM O SEU CONSULTOR OU FALE COM O NOSSO TIME DE TELEVENDAS PELO (33) 3277-3030.



# PRODUTOS EM LIQUIDAÇÃO



## TSW



### JAQUETA PRO LINE

<b>CARACTERÍSTICA</b>	Jaqueta esportiva com fechamento por zíper plástico reforçado com proteção na gola   Tecido 100% poliéster e flanelado de alta qualidade, com ótimo desempenho térmico   Possui dois bolsos externos e punho com acabamento liso   Preta e cinza
<b>PROTEÇÃO</b>	UV: 50
<b>MANGAS E CINTURA</b>	Manga longa com punho liso e cintura lisa
<b>BOLSO</b>	Dois bolsos na parte frontal
<b>ZÍPER</b>	Longo frontal com proteção na gola
<b>MATERIAL</b>	100% Poliéster
<b>EMBALAGEM</b>	1 peça

P  21117



### JAQUETA PRO LINE

<b>CARACTERÍSTICA</b>	Jaqueta esportiva com fechamento por zíper plástico reforçado com proteção na gola   Tecido 100% poliéster e flanelado de alta qualidade, com ótimo desempenho térmico   Possui dois bolsos externos e punho com acabamento liso   Cinza e preto
<b>PROTEÇÃO</b>	UV: 50
<b>MANGAS E CINTURA</b>	Manga longa com punho liso e cintura lisa
<b>BOLSO</b>	Dois bolsos na parte frontal
<b>ZÍPER</b>	Longo frontal com proteção na gola
<b>MATERIAL</b>	100% Poliéster
<b>EMBALAGEM</b>	1 peça

P  21113

FOTOS MERAMENTE ILUSTRATIVAS. AS INFORMAÇÕES/CONFIGURAÇÕES DE PRODUTOS PODERÃO SOFRER ALTERAÇÕES SEM AVISO PRÉVIO.

ENTRE EM CONTATO COM O SEU CONSULTOR OU FALE COM O NOSSO TIME DE TELEVENDAS PELO (33) 3277-3030.

# PRODUTOS EM LIQUIDAÇÃO

**TSW**



## BRETELLE PRO LINE

<b>CARACTERÍSTICA</b>	Confeccionado em tecido de poliamida + elastano Forro de bi-densidade 80/40   Gel interno   Abertura frontal a altura da virilha
<b>PROTEÇÃO</b>	UV-50
<b>MATERIAL</b>	Poliamida + elastano
<b>EMBALAGEM</b>	1 peça

\* Possui abertura frontal na altura da virilha



P		-	P		21066	P		21069	P		21072	P		21075	P		21078
M		21064	M		21067	M		21070	M		21073	M		21076	M		-
G		-	G		-	G		21071	G		21074	G		21077	G		-

FOTOS MERAMENTE ILUSTRATIVAS. AS INFORMAÇÕES/CONFIGURAÇÕES DE PRODUTOS PODERÃO SOFRER ALTERAÇÕES SEM AVISO PRÉVIO.

ENTRE EM CONTATO COM O SEU CONSULTOR OU FALE COM O NOSSO TIME DE TELEVENDAS PELO (33) 3277-3030.

# PRODUTOS EM LIQUIDAÇÃO

## TSW



### BRETELLE RIDE LINE

CARACTERÍSTICA	Confeccionado em tecido de poliamida + elastano   Forro de bi-densidade 80/40   Gel interno
PROTEÇÃO	UV-50
MATERIAL	Poliamida + elastano
EMBALAGEM	1 peça

P		21025	P		21029	P		21033	P		21037	P		21041
M		-	M		-	M		21034	M		21038	M		21042
GG		-				G		-	G		21039	G		21043
			GG		-									

FOTOS MERAMENTE ILUSTRATIVAS. AS INFORMAÇÕES/CONFIGURAÇÕES DE PRODUTOS PODERÃO SOFRER ALTERAÇÕES SEM AVISO PRÉVIO.

ENTRE EM CONTATO COM O SEU CONSULTOR OU FALE COM O NOSSO TIME DE TELEVENDAS PELO (33) 3277-3030.

# PRODUTOS EM LIQUIDAÇÃO

## TSW



P 18999  
G -



P 19002  
M -  
G 19004



### BRETELLE ELITE TEAM RACE

<b>CARACTERÍSTICA</b>	Modelagem Slim   Tecido com memória elástica
<b>PROTEÇÃO</b>	UV: 50+   Ação Antibacteriana
<b>MANGAS E PERNAS</b>	Pernas com acabamento convencional
<b>BOLSO</b>	N/A
<b>ZÍPER</b>	N/A

<b>MATERIAL</b>	Tecido 1: 77% Poliéster   23% Elastano Tecido 2: 85% Poliéster   15% Elastano
<b>FORRO</b>	Espuma D-80
<b>SKINFIT 3 TECIDOS</b>	Combinação estratégica com diferentes tecidos de diferentes comportamentos, melhorando absorção de suor, Flexibilidade e conforto
<b>EMBALAGEM</b>	10 peças

FOTOS MERAMENTE ILUSTRATIVAS. AS INFORMAÇÕES/CONFIGURAÇÕES DE PRODUTOS PODERÃO SOFRER ALTERAÇÕES SEM AVISO PRÉVIO.

ENTRE EM CONTATO COM O SEU CONSULTOR OU FALE COM O NOSSO TIME DE TELEVENDAS PELO (33) 3277-3030.

## TSW

### BRETELLE SUNNY RIDE LINE

CARACTERÍSTICA	Ajusta melhor ao corpo para um melhor desempenho
PROTEÇÃO	UV: 50   Ação Antibacteriana
MATERIAL	87% Poliéster 13% Elastano
FORRO	Ação Antibacteriana   Densidade: 80   Espessura 16 mm   Tamanho 350 x 210 mm
EMBALAGEM	1 peça

P 1  
1  13465























# PRODUTOS EM LIQUIDAÇÃO

## TSW



### BERMUDA RIDE LINE

<b>CARACTERÍSTICA</b>	Confeccionada em tecido de poliamida + elastano Forro de bi-densidade 80/40   Gel interno   Bolso lateral
<b>PROTEÇÃO</b>	UV-50
<b>MATERIAL</b>	Poliamida + elastano
<b>EMBALAGEM</b>	1 peça

P  21005	P  21009	P  21013	P  21017	P  21021
M  -	M  -	M  -	M  -	M  -
G  -	G  -	G  -	G  -	G  -
GG  -	GG  -	GG  -	GG  -	GG  -

FOTOS MERAMENTE ILUSTRATIVAS. AS INFORMAÇÕES/CONFIGURAÇÕES DE PRODUTOS PODERÃO SOFRER ALTERAÇÕES SEM AVISO PRÉVIO.

ENTRE EM CONTATO COM O SEU CONSULTOR OU FALE COM O NOSSO TIME DE TELEVENDAS PELO (33) 3277-3030.



## TSW



1



2

### BERMUDA STORM para ciclismo | PRO LINE

<b>CARACTERÍSTICA</b>	Ajusta melhor ao corpo para um melhor desempenho
<b>PROTEÇÃO</b>	UV: 50   Ação Antibacteriana
<b>ACABAMENTO</b>	Fita elástica siliconada
<b>MATERIAL</b>	87% Poliéster 13% Elastano
<b>FORRO</b>	Ação Antibacteriana   Densidade: 80   Espessura 16 mm   Tamanho 350 x 210 mm
<b>EMBALAGEM</b>	1 peça

	P	G
1	13518	1  -
2	13514	
GG		
1	-	
2	-	

FOTOS MERAMENTE ILUSTRATIVAS. AS INFORMAÇÕES/CONFIGURAÇÕES DE PRODUTOS PODERÃO SOFRER ALTERAÇÕES SEM AVISO PRÉVIO.

ENTRE EM CONTATO COM O SEU CONSULTOR OU FALE COM O NOSSO TIME DE TELEVENDAS PELO (33) 3277-3030.



P	21871
M	-
G	-
GG	-



### BERMUDA RIDE LINE TSW

#### CARACTERÍSTICA

Modelagem anatômica que resulta em maior conforto. Bermuda esportiva. Possui ótimo ajuste ao corpo garantindo conforto e elasticidade para prática de ciclismo

Possui bolso lateral. Confeccionada também material texturizado elástico na barra gerando maior conforto e liberdade de movimento durante a prática do exercício e melhor ajuste ao corpo

Forro com bi densidade D-80 / D-40 de espuma com ação Antibacteriana. Formato curvo e anatômico que se ajusta ao corpo do ciclista oferecendo maior conforto mesmo em pedais de longa duração

#### PROTEÇÃO

UV-50

#### MATERIAL

90% poliamida e 10% elastano

#### EMBALAGEM

1 peça



### FORRO (Cycling Pad) | Modelo 05

#### CARACTERÍSTICA

Forro para roupas de ciclismo | Masculino

#### TECNOLOGIA

Hygroscopic Quick Dry

#### DENSIDADE

55+80

#### ESPESSURA

12 mm

#### MATERIAL

Warp Knitting (85% poliéster / 15% spandex)

#### TAMANHO

355 x 220 mm

#### EMBALAGEM

500 peças

13801

## TSW



### BERMUDA SUNNY para ciclismo | RIDE LINE

**CARACTERÍSTICA** Ajusta melhor ao corpo para um melhor desempenho

**PROTEÇÃO** UV: 50 | Ação Antibacteriana

**MATERIAL** 87% Poliéster  
13% Elastano

**FORRO** Ação Antibacteriana  
| Densidade: 80 |  
Espessura 16 mm  
| Tamanho 350 x  
210 mm

**EMBALAGEM** 1 peça

P		
1		13522
4		13534

# PRODUTOS EM LIQUIDAÇÃO

## TSW



M 19303  
G 19306



P -  
M 19314  
G 19315



P -  
M 19317  
G 19318



M 19320  
G 19321



M 19332  
G 19333



P 19334  
M 19335  
G 19336



### MACAQUINHO para ciclismo | SUMMER

<b>CARACTERÍSTICA</b>	Modelagem Slim   Tecido com memória elástica
<b>PROTEÇÃO</b>	UV: 50   Ação Antibacteriana
<b>MANGAS E PERNAS</b>	Acabamento Neo Cut (corte a laser)   Pernas com fita elástica siliconada
<b>BOLSO</b>	Traseiro
<b>ZÍPER</b>	Longo   Smart Lock (controle de trava do zíper)   Puxador emborrachado

<b>MATERIAL</b>	84% Poliéster   16% Elastano
<b>FORRO</b>	Espuma D-80
<b>SKINFIT 3 TECIDOS</b>	Combinação estratégica com diferentes tecidos de diferentes comportamentos melhorando absorção de suor, flexibilidade e conforto
<b>EMBALAGEM</b>	10 peças

FOTOS MERAMENTE ILUSTRATIVAS. AS INFORMAÇÕES/CONFIGURAÇÕES DE PRODUTOS PODERÃO SOFRER ALTERAÇÕES SEM AVISO PRÉVIO.

ENTRE EM CONTATO COM O SEU CONSULTOR OU FALE COM O NOSSO TIME DE TELEVENDAS PELO (33) 3277-3030.

## TSW



### MACAQUINHO WOMAN FASHION para ciclismo | MANDALA

<b>CARACTERÍSTICA</b>	Ajusta melhor ao corpo para um melhor desempenho   Bolso traseiro   Proteção UV: 50   Ação antibacteriana
<b>MANGAS E PERNAS</b>	Fita elástica siliconada   Corte a laser
<b>ZÍPER</b>	Longo   Smart Lock (controle de trava do zíper)
<b>MATERIAL</b>	100% Poliéster
<b>FORRO</b>	Ação Antibacteriana   Densidade: 80   Espessura 16 mm   Tamanho 350 x 210 mm
<b>TAMANHO</b>	P, M, G, GG
<b>EMBALAGEM</b>	1 peça

P  -

M  -

GG  13571

## TSW



### MACAQUINHO para ciclismo | FLOWER

<b>CARACTERÍSTICA</b>	Modelagem Slim   Melhor ajuste ao corpo elevando o desempenho durante a atividade do ciclista   Tecido com memória elástica
<b>PROTEÇÃO</b>	UV: 50   Ação Antibacteriana
<b>MANGAS E PERNAS</b>	Neo Cut (corte a laser)   Fita elástica siliconada (pernas)
<b>BOLSO</b>	Traseiro
<b>ZÍPER</b>	Longo   Smart Lock (controle de trava do zíper)   Puxador emborrachado
<b>MATERIAL</b>	84% Poliéster   16% Elastano
<b>FORRO</b>	Espuma D-80   Forro em Gel Cool Max
<b>SKINFIT 3 TECIDOS</b>	Combinação estratégica com diferentes tecidos de diferentes comportamentos melhorando absorção de suor, flexibilidade e conforto
<b>EMBALAGEM</b>	1 peça

P \_\_\_\_\_ 14535

G \_\_\_\_\_ -

# PRODUTOS EM LIQUIDAÇÃO

## TSW



### MACAQUINHO para ciclismo | CIBER

<b>CARACTERÍSTICA</b>	Modelagem Slim   Melhor ajuste ao corpo elevando o desempenho durante a atividade do ciclista   Tecido com memória elástica
<b>PROTEÇÃO</b>	UV: 50   Ação Antibacteriana
<b>MANGAS E PERNAS</b>	Neo Cut (corte a laser)   Fita elástica siliconada (pernas)
<b>BOLSO</b>	Traseiro
<b>ZÍPER</b>	Longo   Smart Lock (controle de trava do zíper)   Puxador emborrachado
<b>MATERIAL</b>	84% Poliéster   16% Elastano
<b>FORRO</b>	Espuma D-80   Forro em Gel Cool Max
<b>SKINFIT 3 TECIDOS</b>	Combinação estratégica com diferentes tecidos de diferentes comportamentos melhorando absorção de suor, flexibilidade e conforto
<b>EMBALAGEM</b>	1 peça
<b>P</b>	14544
<b>M</b>	14545

### MACAQUINHO para ciclismo | SKY

<b>CARACTERÍSTICA</b>	Modelagem Slim   Melhor ajuste ao corpo elevando o desempenho durante a atividade do ciclista   Tecido com memória elástica
<b>PROTEÇÃO</b>	UV: 50   Ação Antibacteriana
<b>MANGAS E PERNAS</b>	Neo Cut (corte a laser)   Fita elástica siliconada (pernas)
<b>BOLSO</b>	Traseiro
<b>ZÍPER</b>	Longo   Smart Lock (controle de trava do zíper)   Puxador emborrachado
<b>MATERIAL</b>	84% Poliéster   16% Elastano
<b>FORRO</b>	Espuma D-80   Forro em Gel Cool Max
<b>SKINFIT 3 TECIDOS</b>	Combinação estratégica com diferentes tecidos de diferentes comportamentos melhorando absorção de suor, flexibilidade e conforto
<b>EMBALAGEM</b>	1 peça
<b>P</b>	14548

FOTOS MERAMENTE ILUSTRATIVAS. AS INFORMAÇÕES/CONFIGURAÇÕES DE PRODUTOS PODERÃO SOFRER ALTERAÇÕES SEM AVISO PRÉVIO.

ENTRE EM CONTATO COM O SEU CONSULTOR OU FALE COM O NOSSO TIME DE TELEVENDAS PELO (33) 3277-3030.

## TSW



### MACAQUINHO para ciclismo | FIBER

<b>CARACTERÍSTICA</b>	Modelagem Slim   Melhor ajuste ao corpo elevando o desempenho durante a atividade do ciclista   Tecido com memória elástica
<b>PROTEÇÃO</b>	UV: 50   Ação Antibacteriana
<b>MANGAS E PERNAS</b>	Neo Cut (corte a laser)   Fita elástica siliconada (pernas)
<b>BOLSO</b>	Traseiro
<b>ZÍPER</b>	Longo   Smart Lock (controle de trava do zíper)   Puxador emborrachado
<b>MATERIAL</b>	84% Poliéster   16% Elastano
<b>FORRO</b>	Espuma D-80   Forro em Gel Cool Max
<b>SKINFIT 3 TECIDOS</b>	Combinação estratégica com diferentes tecidos de diferentes comportamentos melhorando absorção de suor, flexibilidade e conforto
<b>EMBALAGEM</b>	1 peça
<b>P</b>	14552





### MACAQUINHO manga longa para ciclismo | FLOWER

<b>CARACTERÍSTICA</b>	Modelagem Slim   Melhor ajuste ao corpo elevando o desempenho durante a atividade do ciclista   Tecido com memória elástica
<b>PROTEÇÃO</b>	UV: 50   Ação Antibacteriana
<b>MANGAS E PERNAS</b>	Mangas longa   Pernas com Neo Cut (corte a laser)   Fita elástica siliconada
<b>BOLSO</b>	Traseiro
<b>ZÍPER</b>	Longo   Smart Lock (controle de trava do zíper)   Puxador emborrachado
<b>MATERIAL</b>	84% Poliéster   16% Elastano
<b>FORRO</b>	Espuma D-80   Forro em Gel Cool Max
<b>SKINFIT 3 TECIDOS</b>	Combinação estratégica com diferentes tecidos de diferentes comportamentos melhorando absorção de suor, flexibilidade e conforto
<b>EMBALAGEM</b>	1 peça

P	-
M	15610
G	15611



### Macaquinho manga longa para ciclismo | BIRD

<b>CARACTERÍSTICA</b>	Modelagem Slim   Melhor ajuste ao corpo elevando o desempenho durante a atividade do ciclista   Tecido com memória elástica
<b>PROTEÇÃO</b>	UV: 50   Ação Antibacteriana
<b>MANGAS E PERNAS</b>	Mangas longa   Pernas com Neo Cut (corte a laser)   Fita elástica siliconada
<b>BOLSO</b>	Traseiro
<b>ZÍPER</b>	Longo   Smart Lock (controle de trava do zíper)   Puxador emborrachado
<b>MATERIAL</b>	84% Poliéster   16% Elastano
<b>FORRO</b>	Espuma D-80   Forro em Gel Cool Max
<b>SKINFIT 3 TECIDOS</b>	Combinação estratégica com diferentes tecidos de diferentes comportamentos melhorando absorção de suor, flexibilidade e conforto
<b>EMBALAGEM</b>	1 peça

M	15613
G	15614

## TSW



### MACAQUINHO manga longa para ciclismo | CIBER

<b>CARACTERÍSTICA</b>	Modelagem Slim   Melhor ajuste ao corpo elevando o desempenho durante a atividade do ciclista   Tecido com memória elástica
<b>PROTEÇÃO</b>	UV: 50   Ação Antibacteriana
<b>MANGAS E PERNAS</b>	Mangas longa   Pernas com Neo Cut (corte a laser)   Fita elástica siliconada
<b>BOLSO</b>	Traseiro
<b>ZÍPER</b>	Longo   Smart Lock (controle de trava do zíper)   Puxador emborrachado
<b>MATERIAL</b>	84% Poliéster   16% Elastano
<b>FORRO</b>	Espuma D-80   Forro em Gel Cool Max
<b>SKINFIT 3 TECIDOS</b>	Combinação estratégica com diferentes tecidos de diferentes comportamentos melhorando absorção de suor, flexibilidade e conforto
<b>EMBALAGEM</b>	1 peça
<b>M</b>	15619
<b>G</b>	15620

FOTOS MERAMENTE ILUSTRATIVAS. AS INFORMAÇÕES/CONFIGURAÇÕES DE PRODUTOS PODERÃO SOFRER ALTERAÇÕES SEM AVISO PRÉVIO.

ENTRE EM CONTATO COM O SEU CONSULTOR OU FALE COM O NOSSO TIME DE TELEVENDAS PELO (33) 3277-3030.

# PRODUTOS EM LIQUIDAÇÃO

## TSW



### MACAQUINHO manga longa para ciclismo | SKY

<b>CARACTERÍSTICA</b>	Modelagem Slim   Melhor ajuste ao corpo elevando o desempenho durante a atividade do ciclista   Tecido com memória elástica
<b>PROTEÇÃO</b>	UV: 50   Ação Antibacteriana
<b>MANGAS E PERNAS</b>	Mangas longa   Pernas com Neo Cut (corte a laser)   Fita elástica siliconada
<b>BOLSO</b>	Traseiro
<b>ZIPER</b>	Longo   Smart Lock (controle de trava do zipper)   Puxador emborrachado
<b>MATERIAL</b>	84% Poliéster   16% Elastano
<b>FORRO</b>	Espuma D-80   Forro em Gel Cool Max
<b>SKINFIT 3 TECIDOS</b>	Combinação estratégica com diferentes tecidos de diferentes comportamentos melhorando absorção de suor, flexibilidade e conforto
<b>EMBALAGEM</b>	1 peça

P 15621

M 15622

G 15623



### MACAQUINHO manga longa para ciclismo | FIBER

<b>CARACTERÍSTICA</b>	Modelagem Slim   Melhor ajuste ao corpo elevando o desempenho durante a atividade do ciclista   Tecido com memória elástica
<b>PROTEÇÃO</b>	UV: 50   Ação Antibacteriana
<b>MANGAS E PERNAS</b>	Mangas longa   Pernas com Neo Cut (corte a laser)   Fita elástica siliconada
<b>BOLSO</b>	Traseiro
<b>ZIPER</b>	Longo   Smart Lock (controle de trava do zipper)   Puxador emborrachado
<b>MATERIAL</b>	84% Poliéster   16% Elastano
<b>FORRO</b>	Espuma D-80   Forro em Gel Cool Max
<b>SKINFIT 3 TECIDOS</b>	Combinação estratégica com diferentes tecidos de diferentes comportamentos melhorando absorção de suor, flexibilidade e conforto
<b>EMBALAGEM</b>	1 peça

M 15625

G 15626

FOTOS MERAMENTE ILUSTRATIVAS. AS INFORMAÇÕES/CONFIGURAÇÕES DE PRODUTOS PODERÃO SOFRER ALTERAÇÕES SEM AVISO PRÉVIO.

ENTRE EM CONTATO COM O SEU CONSULTOR OU FALE COM O NOSSO TIME DE TELEVENDAS PELO (33) 3277-3030.

## TSW









### SAPATILHA MTB NEW FIT PLUS

**CARACTERÍSTICA** 3 velcros | Numeração europeia | Chave allen 4 mm

**PESO** 825g (tam.43 UE)

**EMBALAGEM** 10 peças

37		-
38		-
39		-
40		-
41		17088
42		17087

FOTOS MERAMENTE ILUSTRATIVAS. AS INFORMAÇÕES/CONFIGURAÇÕES DE PRODUTOS PODERÃO SOFRER ALTERAÇÕES SEM AVISO PRÉVIO.

ENTRE EM CONTATO COM O SEU CONSULTOR OU FALE COM O NOSSO TIME DE TELEVENDAS PELO (33) 3277-3030.

## TSW



### SAPATILHA MTB NEW FIT

**CARACTERÍSTICA** Com 3 velcros  
| Numeração  
européia

**EMBALAGEM** 1 peça

41  -

42  07947

## TSW



40	■	-
47	■	-
48	■	13285

### SAPATILHA ROAD SMART-U2

<b>CARACTERÍSTICA</b>	Sistema de fechamento Atop Lacing System   Alça de ajuste anatômico, faixa refletiva   Numeração européia
<b>EMBALAGEM</b>	1 peça
<b>PESO</b>	645g (tam.43 UE)

### MEIAS RIDE para ciclismo | MODELO 01

<b>CARACTERÍSTICA</b>	Tamanho único
<b>TAMANHO</b>	39-43
<b>MODALIDADE</b>	Speed e MTB
<b>COMPRESSÃO</b>	Suave
<b>MATERIAL</b>	Fibra de Poliamida   65% Poliéster, 30% Fita elástica, 5% Spandex
<b>EMBALAGEM</b>	10 peças

3	■	-
5	■	13592



# PRODUTOS EM LIQUIDAÇÃO

## TSW



1

2

3

4

### CARAMANHOLA FAST

**CARACTERÍSTICA** Flexível para apertar | Tampa Inteligente ( abre e fecha) | Bico removível para limpeza | Boca larga (facilita a limpeza e abastecimento) | BPA free | Alça de transporte

**CAPACIDADE** 650 ml

**TAMANHO** ø 7 cm | Altura: 24 cm

**EMBALAGEM** 1 peça

1 ■■■ 14724

2 ■■■ 14725

3 ■■■ 14726

4 ■■■ 14727



1

2

3

4



### CARAMANHOLA PIVOT SMART

**CARACTERÍSTICA** Flexível para apertar | BPA free | Tampa Inteligente ( abre e fecha) | Bico removível para limpeza | Boca larga (facilita a limpeza e abastecimento)

**CAPACIDADE** 560 ml

**TAMANHO** ø 7 cm | Altura 20 cm

**EMBALAGEM** 1 peça

1 ■■■ -

2 ■■■ 14708

4 ■■■ 14709

FOTOS MERAMENTE ILUSTRATIVAS. AS INFORMAÇÕES/CONFIGURAÇÕES DE PRODUTOS PODERÃO SOFRER ALTERAÇÕES SEM AVISO PRÉVIO.

ENTRE EM CONTATO COM O SEU CONSULTOR OU FALE COM O NOSSO TIME DE TELEVENDAS PELO (33) 3277-3030.

# PRODUTOS EM LIQUIDAÇÃO

## TSW



1



3



4



### CARAMANHOLA PIVOT STANDARD

**CARACTERÍSTICA** Flexível para apertar | Protetor de bico | BPA free | Boca larga (facilita a limpeza e abastecimento)

**CAPACIDADE** 560 ml

**TAMANHO** ø 7 cm | Altura 18,5 cm

**EMBALAGEM** 1 peça

1  14732

3  14736

4  -

FOTOS MERAMENTE ILUSTRATIVAS. AS INFORMAÇÕES/CONFIGURAÇÕES DE PRODUTOS PODERÃO SOFRER ALTERAÇÕES SEM AVISO PRÉVIO.

ENTRE EM CONTATO COM O SEU CONSULTOR OU FALE COM O NOSSO TIME DE TELEVENDAS PELO (33) 3277-3030.



## TSW



### MOCHILA DE HIDRATAÇÃO Camuflado

CARACTERÍSTICA	Alça macia   Faixa refletiva em 8 pontos   Alça elástica externa   Bolso frontal com zíper   Refil interno
REFIL	2 litros   Tampa com fechamento em rosca   Tubo de 106 cm
TAMANHO	450 mm x 80 x 230 mm
PESO	567g
EMBALAGEM	5 peças
	15426



### MOCHILA DE HIDRATAÇÃO Preto e Cinza

CARACTERÍSTICA	Faixa refletiva em 8 pontos   Alça elástica externa   Bolso frontal com zíper   Refil interno
REFIL	2 litros   Tampa com fechamento em rosca   Tubo de 106 cm
TAMANHO	450mm x 80 x 230 mm
PESO	536g
EMBALAGEM	5 peças
	15425



### MANOPLA MTB

MATERIAL	pvc.tpr
EMBALAGEM	100 peças

1 06907

### SUPORTE PARA CARAMANHOLA Colors

PESO	32g
MATERIAL	Nylon
EMBALAGEM	10 peças

15519

-



### BOLSA CELULAR GRANDE

CARACTERÍSTICA	Saída de fone de ouvido   Suporte a touch
TAMANHO	200x140x80mm
CAPACIDADE	2,24 litros
PESO	89g
EMBALAGEM	50 peças

07148

## TSW



### BONÉ ORANGE

CARACTERÍSTICA	Fecho de velcro
MATERIAL	100% poliéster
EMBALAGEM	50 peças
FATOR	5

15143



## TSW



### BONÉ BLACK

CARACTERÍSTICA	Fecho de velcro
MATERIAL	100% poliéster
EMBALAGEM	50 peças
FATOR	5

15144



### BONÉ GROUND

CARACTERÍSTICA	Fecho de velcro
MATERIAL	100% poliéster
EMBALAGEM	50 peças
FATOR	5

15145



## TSW



### BOLSA DE SELIM Modelo 04

CARACTERÍSTICA	Suporte de fixação no selim
TAMANHO	170x120x80mm
CAPACIDADE	1,632 litros
PESO	163g
EMBALAGEM	50 peças

1  07045

2  10501



### BOLSA DE SELIM Modelo 03

CARACTERÍSTICA	Bolsa de Selim com isolamento interno resistente a água   Fixação no canote e no trilho do selim com clips de nylon e fita regulável   Fechamento principal com clip e velcros auxiliares   Bolsinho interno de rede PVC
----------------	--

MATERIAL Nylon

TAMANHO Comprimento 24cm - Largura 10x13cm

PESO 160 gr

EMBALAGEM 20 peças

1  07044

2  10500

## TSW

2



3



### SELIM MTB 6748

CARACTERÍSTICA	Trilho de aço
PESO	350g
TAMANHO	280*143mm
EMBALAGEM	30 peças

1  11362

2  11360

3  -

4



### SELIM MTB PRETO MOD. CR TSW-145

CARACTERÍSTICA	Trilho de Cromoly   Vazado
PESO	243g
TAMANHO	260*130mm
EMBALAGEM	30 peças

 22666



## TSW

### SUPORTE GUIDÃO AHEAD 90MM/7°

CARACTERÍSTICA	Ahead Set
EXTENSÃO	80mm/90mm/100mmx31.8mm/7°
MATERIAL	Alumínio
TAMANHO	100 mm, 80 mm, 90 mm
EMBALAGEM	50 peças
PESO	157 g

05821





# PRODUTOS EM LIQUIDAÇÃO



## TSW

### SUP. GUIDÃO ALUM. MTB AHEAD 90MM

#### CARACTERÍSTICA

Suporte de guidão tsw  
 Diâmetro do encaixe do guidão 31.8mm  
 Comprimento 90mm  
 Ângulo +-7°  
 Cores disponíveis: preto/amarelo – preto/azul –  
 preto/branco – preto/verde - preto/vermelho

#### MATERIAL

Alumínio

#### PESO

159g

#### EMBALAGEM

50 Unidades



17619



17620



-



-



17624



FOTOS MERAMENTE ILUSTRATIVAS. AS INFORMAÇÕES/CONFIGURAÇÕES DE PRODUTOS PODERÃO SOFRER ALTERAÇÕES SEM AVISO PRÉVIO.

ENTRE EM CONTATO COM O SEU CONSULTOR OU FALE COM O NOSSO TIME DE TELEVENDAS PELO (33) 3277-3030.



**PRODUTOS EM LIQUIDAÇÃO**

**TSW**



**ROLO DE TREINO | Modelo 09**

<b>CARACTERÍSTICA</b>	Sistema magnético   Alavanca de controle de carga no guidão
<b>COMPATIBILIDADE</b>	700x38c (roda com pneu) / 29 x 2.10" (roda com pneu e eixo de 9 x 135 mm)
<b>MATERIAL</b>	Aço
<b>EMBALAGEM</b>	1 peça
	15217

FOTOS MERAMENTE ILUSTRATIVAS. AS INFORMAÇÕES/CONFIGURAÇÕES DE PRODUTOS PODERÃO SOFRER ALTERAÇÕES SEM AVISO PRÉVIO.

ENTRE EM CONTATO COM O SEU CONSULTOR OU FALE COM O NOSSO TIME DE TELEVENDAS PELO (33) 3277-3030.

# PRODUTOS EM LIQUIDAÇÃO

## TSW



### FAROL 900 LUMENS

**CARACTERÍSTICA** Bateria recarregável via USB |  
Autonomia  
15h (20% de brilho)  
6h (50% de brilho)  
3h (100% de brilho)  
8h (Flash rápido)  
10h (Flash lento)  
5 estágios  
Lúmens 900  
Especificidade 2 LED  
Tempo de recarga 6 horas

**EMBALAGEM** 1 peça

08660

### SUPOORTE FAROL PORTÁTIL para capacete

**CARACTERÍSTICA** Alça com velcro completa | 38cm

**EMBALAGEM** 1 peça

08663



### FAROL LED TSW 600 LUMENS

**CARACTERÍSTICA** Bateria recarregável via USB  
Base móvel | 5 estágios:  
20% de brilho(13h)  
50% de brilho(5h)  
100% de brilho(2h30)  
Flash rápido(10h)  
Flash lento(8h)  
Lúmens 600, 2 LED  
Carga: 2h (dependendo da usb)

**EMBALAGEM** 1 peça

10980

FOTOS MERAMENTE ILUSTRATIVAS. AS INFORMAÇÕES/CONFIGURAÇÕES DE PRODUTOS PODERÃO SOFRER ALTERAÇÕES SEM AVISO PRÉVIO.

ENTRE EM CONTATO COM O SEU CONSULTOR OU FALE COM O NOSSO TIME DE TELEVENDAS PELO (33) 3277-3030.



### REFLETOR TRASEIRO 15 Lumens

CARACTERÍSTICA	Led vermelho   Com 4 modos de iluminação   Suporte para fixação no canote   Cabo USB para recarga
AUTONOMIA	3h (Luz intensa) 15h (Flash alternado) 6h (Flash) 8h (Flash alternado 2)
PESO	22 g
MATERIAL	Plástico
NÍVEL DE RESISTÊNCIA À ÁGUA	IP65
TEMPO DE RECARGA	1h
EMBALAGEM	120 peças 15223

### GARFO SUSPENSÃO 26" (Over com Rosca)

MATERIAL	Aço
CARACTERÍSTICA	Over Rosca Curso da Suspensão 70 mm Diâmetro da Espiga 25,4 mm Comprimento da Espiga 15 cm
FREIO	Disc Brake (Standard)   V-Brake
PESO	2.39 kg
EMBALAGEM	6 peças

17871





# PRODUTOS EM LIQUIDAÇÃO



## TSW



### GARFO 29" MTB com suspensão | Alumínio/Aço Ahead RL

MATERIAL	Aço - Kraw de Alumínio
CARACTERÍSTICA	Espiga 25cm Diâmetro 25.4mm   Curso da suspensão 100mm
FREIO	Disc brake (standard)   Trava Remota (Cartucho êmbolo Hidráulico   SEM regulagem de retorno)
PESO APROXIMADO	29" ahead - 820g
EMBALAGEM	6 peças

← 29 →

20433

### HASTE DO RETORNO 560

CARACTERÍSTICA	Haste TSW de Retorno da suspensão Salto   Vermelho   Kit com regulador e parafuso   Compatível com suspensões TSW SALTO modelo 560 aro 29"   Kit com parafuso, mola e batentes
MATERIAL	Alumínio e Aço
PESO	82 gr
EMBALAGEM	20 peças



6246

FOTOS MERAMENTE ILUSTRATIVAS. AS INFORMAÇÕES/CONFIGURAÇÕES DE PRODUTOS PODERÃO SOFRER ALTERAÇÕES SEM AVISO PRÉVIO.

ENTRE EM CONTATO COM O SEU CONSULTOR OU FALE COM O NOSSO TIME DE TELEVENDAS PELO (33) 3277-3030.

# PRODUTOS EM LIQUIDAÇÃO

## TSW



### CUBO DIANTEIRO

**CARACTERÍSTICA** Cubo dianteiro | Alumínio | 32 furos com esfera | Suporte para freio a disco 6 parafusos | Eixo 9mm furado com blocagem | OLD 100mm

**MATERIAL** Alumínio - Eixo de aço furado

**PESO** 273 gr apenas o cubo  
317 gr cubo + blocagem

**EMBALAGEM** 50 peças

**DIANTEIRO 32F**

20485



### ABRAÇADEIRA DE SELIM MTB 34.9MM

**CARACTERÍSTICA** Com blocagem

**MATERIAL** Alumínio

**EMBALAGEM** 20 peças

**34.9MM**

1 12828



### RAIO INOX PRETO

**MATERIAL** Inox

**CARACTERÍSTICA** Sem niple | 32 peças

**EMBALAGEM** 10 pacotes

1 274 X 2.0/1.6MM 05108

2 272 X 2.0/1.6MM 05818

FOTOS MERAMENTE ILUSTRATIVAS. AS INFORMAÇÕES/CONFIGURAÇÕES DE PRODUTOS PODERÃO SOFRER ALTERAÇÕES SEM AVISO PRÉVIO.

ENTRE EM CONTATO COM O SEU CONSULTOR OU FALE COM O NOSSO TIME DE TELEVENDAS PELO (33) 3277-3030.



# PRODUTOS EM LIQUIDAÇÃO



## TSW



ROAD BIKE

### RODA SPEED 32 FUROS (ROSCA)

<u>MODALIDADE</u>	Road (Ciclismo de estrada)
<u>ARO</u>	700c   15 mm (interno)   Válvula Fina   32 furos
<u>RAIO E NIPLES</u>	Preto

CUBO Dianteiro: 100 x 9 mm | Esfera | 32 furos | Blocagem  
/ Traseiro: Cubo Rosca | 7 velocidades | 130 x 9 mm | Esfera | 32 furos | Blocagem

PESO APROXIMADO 2.03kg

EMBALAGEM 1 par

17612



### ARO T-7000 BLACK ROAD BIKE

ARO Freio a disco | Parede dupla

MEDIDAS 700c - 622x14.9 mm

ERD 575 mm

FURO 32 furos

MATERIAL Alumínio 6061

PNEU 700 x 19, 700 x 30

VÁLVULA Fina ( Presta )

PESO 490g

EMBALAGEM 1 peça

17852

FOTOS MERAMENTE ILUSTRATIVAS. AS INFORMAÇÕES/CONFIGURAÇÕES DE PRODUTOS PODERÃO SOFRER ALTERAÇÕES SEM AVISO PRÉVIO.

ENTRE EM CONTATO COM O SEU CONSULTOR OU FALE COM O NOSSO TIME DE TELEVENDAS PELO (33) 3277-3030.

### CABO CONDUÍTE DE FREIO

CARACTERÍSTICA	Cabo para freio   Espiral   Teflon
COMPRIMENTO	20 m
ESPESSURA	5 mm
EMBALAGEM	25 peças

14144



NÚCLEO REMOVÍVEL

PORCA DE APERTO CHANFRADA

### VÁLVULAS TUBELESS PRÓ

CARACTERÍSTICA	Presta 36, 48, 60 mm   Haste de válvula com núcleo removível para facilitar colocação do selante   100% Alumínio: tampa, corpo e base, mais leve e resistente
MATERIAL	Alumínio
PESO APROXIMADO	10g
EMBALAGEM	10 peças
36MM	11815
48MM	-
60MM	-



BASE COM FURO PARA EVITAR ENTUPIAMENTOS

### FITA ANTI FURO BRANCA

#### CARACTERÍSTICA

Instalada entre o pneu e a câmara, reduz as chances de furos no pneu funcionando como uma camada extra de proteção contra objetos perfurantes

#### EMBALAGEM

20 peças



#### TAMANHO

29" x 0.5 x 40 mm

#### PESO APROXIMADO

57g

13755



#### TAMANHO

700c x 0.5 x 25 mm

#### PESO APROXIMADO

30g

13756

### ESPAÇADOR MOVIMENTO DE DIREÇÃO 15 MM

#### CARACTERÍSTICA

Espaçador de movimento de direção TSW | Branco | Altura: 15 mm | Kit com 10 unidades

#### ESPAÇADOR

Calço para direção AHEADSET

#### MATERIAL

Alumínio

#### PESO

10 gr (a unidade)

#### EMBALAGEM

100 peças

4467





### EIXO DIANTEIRO completo para roda T-900



<u>CARACTERÍSTICA</u>	Eixo dianteiro TSW em alumínio vazado com rolamentos   Eixo dianteiro completo vazado com rolamentos   OLD 100 mm   Rolamento de esferas de sulco profundo   Id (diâmetro interno do rolamento): 15 mm   Od (diâmetro externo do rolamento): 28 mm   Largura do rolamento: 7 mm
<u>COMPATIBILIDADE</u>	Compatível com suspensões que possuem eixo de 9 mm
<u>MEDIDA DO ROLAMENTO</u>	6902-2rs
<u>FECHOS DO ROLAMENTO</u>	2 selados
<u>LUBRIFICAÇÃO DO ROLAMENTO</u>	Graxa
<u>DIMENSÕES DO ROLAMENTO</u>	15 x 28 x 7 mm
<u>MATERIAL</u>	Alumínio
<u>PESO</u>	82 gr
<u>EMBALAGEM</u>	20 peças

5807



### MANÔMETRO de Nylon para bomba

<u>CARACTERÍSTICA</u>	Manômetro analógico TSW   Preta   Bomba oficina   Kit 1 unidade
<u>MATERIAL</u>	Plástico
<u>PRESSÃO MÁXIMA</u>	145PSI/ 10BAR
<u>PESO</u>	30 gr
<u>EMBALAGEM</u>	50 peças

8203



### FITA DEMARCADORA

<u>CARACTERÍSTICA</u>	Leitosa
<u>TAMANHO ROLO</u>	10x00.8cm
<u>EMBALAGEM</u>	1 rolo

08061



# PRODUTOS EM LIQUIDAÇÃO



## TSW



### TRANSBIKE FORCE 2

<b>CARACTERÍSTICA</b>	Transbike de engate   Fixado por parafuso sextavado (24 mm)   Reclinável	<b>SINALIZAÇÃO</b>	Luz do freio   Setas   Lanterna traseira
<b>TAMANHO</b>	107 x 56 x 88 cm	<b>LUZES DE LED</b>	Não
<b>CAPACIDADE DE CARGA</b>	30 kg	<b>TRAVAS</b>	Suporte de quadros e engate com trava por chave   Suporte de rodas com engate rápido e ajuste micrométrico
<b>PESO</b>	13.63 kg	<b>EMBALAGEM</b>	1 peça
<b>CONECTOR DE ENERGIA</b>	7-Pin		
<b>ADAPTADOR PARA 13-PIN</b>	Não incluso		14382

### EXPOSITOR para capacete

<b>CARACTERÍSTICA</b>	Para usar em slatewall
<b>MATERIAL</b>	Nylon
<b>EMBALAGEM</b>	10 peças

1  04510

2  05037



FOTOS MERAMENTE ILUSTRATIVAS. AS INFORMAÇÕES/CONFIGURAÇÕES DE PRODUTOS PODERÃO SOFRER ALTERAÇÕES SEM AVISO PRÉVIO.

ENTRE EM CONTATO COM O SEU CONSULTOR OU FALE COM O NOSSO TIME DE TELEVENDAS PELO (33) 3277-3030.

# PRODUTOS EM LIQUIDAÇÃO

## TSW

### EXPOSITOR DE SAPATILHA

**CARACTERÍSTICA** Peça em nylon para 1 sapatilha

**EMBALAGEM** 1 peça

1  06519

2  06520



### PARAFUSO FIXAÇÃO superior prendedor Transbike Force

19417



**26"**  
WHEELS

IMPORTADO

 17813

### KIT RODA DIANTEIRA/TRASEIRA 36 FUROS

**CARACTERÍSTICA** Roda TSW Aro 26" (559 x 19 mm) com CNC | Acompanha fita protetora de câmara de ar

**ARO** Parede dupla | Alumínio 6063 | ERD 535 mm | 36 furos | Pneu 1.0 à 2.2 | CNC | Freio V/B

**CUBO** Dianteiro: Aço | 36 furos | Esferado | Eixo 9 x 100 mm | Com blocagem  
Traseiro: Aço | 36 furos | Esferado | Rosca (Roda livre) | 9 x 135 mm | Com blocagem

**RAIO** Aço preto | 250 mm x 2,0 mm | Niple preto

**MATERIAL** Aro: Alumínio  
Cubos e raios: Aço

**EMBALAGEM** 1 par

FOTOS MERAMENTE ILUSTRATIVAS. AS INFORMAÇÕES/CONFIGURAÇÕES DE PRODUTOS PODERÃO SOFRER ALTERAÇÕES SEM AVISO PRÉVIO.

ENTRE EM CONTATO COM O SEU CONSULTOR OU FALE COM O NOSSO TIME DE TELEVENDAS PELO (33) 3277-3030.

## RAVA



**SUGEST** MOVIMENTO DE DIREÇÃO

MEGA OVER 13115



**SUGEST** GARFO SUSPENSÃO

29" 8527 / 8881



29

17  15311

### Quadro Pressure MTB 29" Rava 2021

**DIREÇÃO** Mega Over de 44 mm

**CANOTE** 27.2 mm

**FREIO** Disc brake standard

**TUBO MOVIMENTO CENTRAL** BSA 68 mm

**MOVIMENTO CENTRAL** 34.7 mm

**PNEU** Largura máxima de 29 x 2.2

**MATERIAL** Alumínio 6061

**ACABAMENTO** Adesivo não envernizado

**PESO APROXIMADO** 17" - 1800 g

**EMBALAGEM** 2 peças



### Quadro Pressure MTB 29" Rava 2021

**DIREÇÃO** Mega Over de 44 mm

**CANOTE** 27.2 mm

**FREIO** Disc brake standard

**TUBO MOVIMENTO CENTRAL** BSA 68 mm

**MOVIMENTO CENTRAL** 34.7 mm

**PNEU** Largura máxima de 29 x 2.2

**MATERIAL** Alumínio 6061

**ACABAMENTO** Adesivo não envernizado

**PESO APROXIMADO** 17" - 1800 g

**EMBALAGEM** 2 peças

**SUGEST** MOVIMENTO DE DIREÇÃO

MEGA OVER 13115



**SUGEST** GARFO SUSPENSÃO

29" 8527 / 8881



# PRODUTOS EM LIQUIDAÇÃO

## RAVA



### Quadro Pressure MTB 29" Rava 2021

DIREÇÃO	Mega Over de 44 mm
CANOTE	27.2 mm
FREIO	Disc brake standard
TUBO MOVIMENTO CENTRAL	BSA 68 mm
MOVIMENTO CENTRAL	34.7 mm
PNEU	Largura máxima de 29 x 2.2
MATERIAL	Alumínio 6061
ACABAMENTO	Adesivo não envernizado
PESO APROXIMADO	17" - 1800 g
EMBALAGEM	2 peças

#### SUGEST MOVIMENTO DE DIREÇÃO

MEGA OVER 13115



#### SUGEST GARFO SUSPENSÃO

29" 8527 / 8881



29

17  15313



### Quadro Pressure MTB 29" Rava 2021

DIREÇÃO	Mega Over de 44 mm
CANOTE	27.2 mm
FREIO	Disc brake standard
TUBO MOVIMENTO CENTRAL	BSA 68 mm
MOVIMENTO CENTRAL	34.7 mm
PNEU	Largura máxima de 29 x 2.2
MATERIAL	Alumínio 6061
ACABAMENTO	Adesivo não envernizado
PESO APROXIMADO	17" - 1800 g
EMBALAGEM	2 peças

#### SUGEST MOVIMENTO DE DIREÇÃO

MEGA OVER 13115



#### SUGEST GARFO SUSPENSÃO

29" 8527 / 8881



29

17  15315

FOTOS MERAMENTE ILUSTRATIVAS. AS INFORMAÇÕES/CONFIGURAÇÕES DE PRODUTOS PODERÃO SOFRER ALTERAÇÕES SEM AVISO PRÉVIO.

ENTRE EM CONTATO COM O SEU CONSULTOR OU FALE COM O NOSSO TIME DE TELEVENDAS PELO (33) 3277-3030.



# PRODUTOS EM LIQUIDAÇÃO



## RAVA



### Quadro Pressure MTB 29" | Cabeamento Interno

<b>QUADRO</b>	Rava MTB Pressure 29"   Cabeamento da marcha interno   Suporte de freio Standard   Eixo traseiro 135 mm x 9 mm   Blocação de rodas, canote e selim
<b>DIREÇÃO</b>	Mega Over semi-integrada de 44 mm
<b>CANOTE</b>	27.2 mm
<b>CAIXA CENTRAL</b>	BSA 68 mm
<b>PNEU</b>	Largura máxima de 29 x 2.2 (com cravos baixos)
<b>MATERIAL</b>	Alumínio 6061
<b>PESO APROXIMADO</b>	17" - 1800 g

#### CINZA

15.5 20052

17 20057

19 -

#### LARANJA/VERMELHO

15.5 20048

17 -

19 20058

#### VERDE

15.5 20049

17 20054

#### FLAMINGO

15.5 -

17 20055

#### AZUL

15.5 20051

17 20056

19 -

FOTOS MERAMENTE ILUSTRATIVAS. AS INFORMAÇÕES/CONFIGURAÇÕES DE PRODUTOS PODERÃO SOFRER ALTERAÇÕES SEM AVISO PRÉVIO.

ENTRE EM CONTATO COM O SEU CONSULTOR OU FALE COM O NOSSO TIME DE TELEVENDAS PELO (33) 3277-3030.



# PRODUTOS EM LIQUIDAÇÃO



## RAVA



### KIT Quadro Pressure 29" RS

<b>DIREÇÃO</b>	Mega Over de 44 mm
<b>CANOTE</b>	27.2 mm
<b>FREIO</b>	Disc brake standard
<b>TUBO MOVIMENTO CENTRAL</b>	BSA 68 mm
<b>MOVIMENTO CENTRAL</b>	34.7 mm
<b>PNEU</b>	Largura máxima de 29 x 2.2
<b>MATERIAL</b>	Alumínio 6061
<b>ACABAMENTO</b>	Adesivo não envernizado
<b>PESO APROXIMADO</b>	17" - 1800 g
<b>EMBALAGEM</b>	7 peças

17  20551

17  20552

17  20553

17  20554

### KIT de Montagem X-Time

<b>GUIDÃO</b>	X-Time   Reto   720 x 31.8 mm   9º backsweep   Alumínio
<b>SUPORTE DE GUIDÃO</b>	X-Time   Ahead set   90 x 31.8 mm / 7º   Alumínio
<b>CANOTE</b>	X-Time   31.6 x 350 mm   Parafuso único   Alumínio
<b>ABRACADEIRA</b>	X-Time   Blocação   34.9 mm   Alumínio
<b>EMBALAGEM</b>	20 pçs

### KIT Garfo Judy

<b>CARACTERÍSTICA</b>	Garfo Suspensão Rock Shox Judy 29"   Curso 100 mm   Trava Remota   Ajuste de Preload   Off set 46 mm   OLD 100 mm   Eixo 9 mm   Espiga Tapered (26.5cm)   Diâmetro Máximo do Pneu 755 mm   Largura Máxima do Pneu 62 mm   Tamanho Máximo do Rotor 185mm   Tamanho mínimo do rotor 160 mm   Trava PopLoc Remote (puxador de cabo de 17 mm)   Sistema de fixação do Caliper Post Mount.
<b>MATERIAL</b>	Alumínio e Aço
<b>PESO</b>	2.328 gr
<b>EMBALAGEM</b>	1 peça

### KIT Trava Remote Rock Shox

<b>CARACTERÍSTICA</b>	Botão da Trava Suspensão Rock Shox Poploc Esquerda 17mm   Compatível com qualquer suspensão Rock Shox como: XC30 - Recon - XC 32 - Reba - XC 28 - Judy   Acompanha cabos e conduítes para montagem   Puxar 17 mm
<b>MATERIAL</b>	Alumínio
<b>PESO</b>	69 gr
<b>EMBALAGEM</b>	20 peças

FOTOS MERAMENTE ILUSTRATIVAS. AS INFORMAÇÕES/CONFIGURAÇÕES DE PRODUTOS PODERÃO SOFRER ALTERAÇÕES SEM AVISO PRÉVIO.

ENTRE EM CONTATO COM O SEU CONSULTOR OU FALE COM O NOSSO TIME DE TELEVENDAS PELO (33) 3277-3030.



# PRODUTOS EM LIQUIDAÇÃO



## RAVA



### KIT Quadro Pressure 29"

**QUADRO** Rava MTB Pressure 29" | Cabeamento da marcha interno | Suporte de Freio Standard | Eixo traseiro 135 mm x 9 mm | Blocação de rodas, canote e selim

**DIREÇÃO** Mega Over semi-integrada de 44 mm

**CANOTE** 27.2 mm

**CAIXA CENTRAL** BSA 68 mm

**PNEU** Largura máxima de 29 x 2.2 (com cravos baixos)

**MATERIAL** Alumínio 6061

**PESO APROXIMADO** 17" - 1800 g

**EMB.** 2 pçs

### KIT de Montagem X-Time

**GUIDÃO** X-Time | Rise bar | 720 x 31.8 mm | 9° backsweep | Rise 20 mm | Alumínio

**SUPOORTE DE GUIDÃO** X-Time | Ahead set | 70 x 31.8 mm / 7° | Alumínio

**CANOTE** X-Time | 27.2 x 350 mm | Parafuso único | Alumínio

**ABRAÇADEIRA** X-Time | Blocação | 31.8 mm | Alumínio

**PESO** 830 gr

### KIT Garfo Rava

**CARACTERÍSTICA** Comprimento da espiga 20.2cm | Espiga Ahead Set | Curso da Suspensão 90mm | Diâmetro da Espiga 25.4mm | Freio: Disc Brake (Standard) | Kraw Alumínio | Lower Leg de aço | Eixo de 9 mm | OLD 100 mm | Preto | MTB

**MATERIAL** Aço - Kraw de alumínio

**PESO** 2.608 kg

### KIT Selim MTB Rava

**MODELO** MTB

**TRILHO** Aço

**TAMANHO** 140 x 270 mm

**PESO** 294 g

LARANJA/VERMELHO	VERDE	FLAMINGO	AZUL	CINZA
15.5  20535	15.5  20536	15.5  20537	15.5  20538	15.5  20539
17  20540	17  20541	17  20542	17  20543	17  20544
19  20545			19  20546	19  20548

FOTOS MERAMENTE ILUSTRATIVAS. AS INFORMAÇÕES/CONFIGURAÇÕES DE PRODUTOS PODERÃO SOFRER ALTERAÇÕES SEM AVISO PRÉVIO.

ENTRE EM CONTATO COM O SEU CONSULTOR OU FALE COM O NOSSO TIME DE TELEVENDAS PELO (33) 3277-3030.





# PRODUTOS EM LIQUIDAÇÃO



## RAVA



### Garfo 29" com Suspensão Rava

**CARACTERÍSTICA** Comprimento da espiga 20.2cm | Espiga Ahead Set | Curso da Suspensão 90mm | Diâmetro da Espiga 25.4mm | Freio: Disc Brake (Standard) | Kraw Alumínio | Lower Leg de aço | Eixo de 9 mm | OLD 100 mm | Preto | MTB

**MATERIAL** Aço - Kraw de alumínio

**PESO** 2.608 kg

**EMBALAGEM** 6 peças

20509



### Garfo MTB 29" com Suspensão Alumínio Ahead Salto TM Preto Rava

**CARACTERÍSTICA** Espiga de alumínio com comprimento de 27,5cm, Curso da Suspensão 100mm, Diâmetro da Espiga 28mm, Freio: Disc brake (Post Mount), Trava manual (Cartucho Êmbolo Hidráulico SEM regulagem de retorno), Lower Leg de alumínio, OLD 100mm, Eixo 9mm, Regulagem de preload

**MATERIAL** Lower Leg Alumínio - Kraw de alumínio | Espiga Alumínio | Canelas Aço

**PESO** 2.364 g

**EMBALAGEM** 6 peças

12895

FOTOS MERAMENTE ILUSTRATIVAS. AS INFORMAÇÕES/CONFIGURAÇÕES DE PRODUTOS PODERÃO SOFRER ALTERAÇÕES SEM AVISO PRÉVIO.

ENTRE EM CONTATO COM O SEU CONSULTOR OU FALE COM O NOSSO TIME DE TELEVENDAS PELO (33) 3277-3030.



# PRODUTOS EM LIQUIDAÇÃO



## RAVA



### Garfo 26" Suspensão Rava (Rosca)

<b>CARACTERÍSTICA</b>	Over   Com rosca   70 mm de curso   Freio a disco Standard / V-Brake
<b>MATERIAL</b>	Aço
<b>PESO</b>	2.39 g
<b>EMBALAGEM</b>	6 peças
	17870

### Garfo 29" Suspensão Rava

<b>CARACTERÍSTICA</b>	Ahead set   1 - 1/8"   70 mm de curso   Freio a disco Standard
<b>MATERIAL</b>	Aço
<b>PESO</b>	2.625 g
<b>EMBALAGEM</b>	6 peças
	15547



FOTOS MERAMENTE ILUSTRATIVAS. AS INFORMAÇÕES/CONFIGURAÇÕES DE PRODUTOS PODERÃO SOFRER ALTERAÇÕES SEM AVISO PRÉVIO.

ENTRE EM CONTATO COM O SEU CONSULTOR OU FALE COM O NOSSO TIME DE TELEVENDAS PELO (33) 3277-3030.

### Garfo MTB 29" com Suspensão Rava

#### CARACTERÍSTICA

Comprimento da espiga: 20.2cm | Espiga Ahead Set | Curso da suspensão 100mm | Diâmetro da espiga: 25.4mm | Freio: Disc Brake (Standard) | Kraw alumínio | Lower leg de aço | Eixo 9mm | Old 100mm

#### MATERIAL

Aço

#### PESO

2.634 kg

#### EMBALAGEM

6 peças

22836



MOUNTAIN BIKE / CICLOTURISMO

### Aro 29" X32F Modelo 03 Rava

#### ARO

Dupla camada | Tubeless Ready | 32 furos | Preto

#### MEDIDAS

29" - 622x23mm

#### PSI MÁXIMO

80 - 40

#### ERD

600mm

#### FREIO

Disc Brake

#### MATERIAL

Alumínio 6063

#### PNEU

1.5" até 2.4"

#### VÁLVULA

Fina (Presta)

#### PESO APROXIMADO

550g (O peso informado pode ter variação de 5% para mais ou para menos devido ao processo de extrusão.)

#### EMBALAGEM

10 peças



32F

17231

## RAVA

### Aro 29" X 32F Alumínio MTB Preto Rava

**ARO** Aro 29" | 19 mm interno  
Alumínio | ETRTO 584 mm  
Folha dupla | 32 Furos  
Largura recomendada da seção do pneu 1" 2.30" (mínima x máxima)  
| Disc Brake

**PESO APROXIMADO** 535g

**EMBALAGEM** 10 peças

IMPORTADO

20584



### Aro 29" X 32F / 36F Modelo 02 Rava

MOUNTAIN BIKE/ CICLOTURISMO

**ARO** Dupla camada

**MEDIDAS** 29" - 622x19mm

**PSI MÁXIMO** 110 - 48

**ERD** 584mm

**FREIO** Disc brake

**MATERIAL** Alumínio 6063

**PNEU** 1.0" até 2.2"

**VÁLVULA** Grossa (Americana)

**PESO APROX.** 550g (O peso informado pode ter variação de 5% para mais ou para menos devido ao processo de extrusão.)

**EMBALAGEM** 10 peças



32F 17229

36F -





# PRODUTOS EM LIQUIDAÇÃO



## RAVA



### Camisa Pro Line Rava

<b>CARACTERÍSTICA</b>	Microfilamento 100% poliéster
<b>PROTEÇÃO</b>	UV-30
<b>EMBALAGEM</b>	1 peça

P  21216

M  -

P  21219

M  21220

P  21222

FOTOS MERAMENTE ILUSTRATIVAS. AS INFORMAÇÕES/CONFIGURAÇÕES DE PRODUTOS PODERÃO SOFRER ALTERAÇÕES SEM AVISO PRÉVIO.

ENTRE EM CONTATO COM O SEU CONSULTOR OU FALE COM O NOSSO TIME DE TELEVENDAS PELO (33) 3277-3030.

# PRODUTOS EM LIQUIDAÇÃO

## RAVA



### Camisa Ride Line Rava

#### CARACTERÍSTICA

Tecido de alta qualidade | Elástico na borda inferior da camisa | Gola alta com fechamento em zíper | Zíper com Smart Lock (controle de trava do zíper) fornecendo assim controle da abertura e ventilação | Manga curta

Bolsos: 3 bolsos traseiros para acondicionar utensílios

#### PROTEÇÃO

UV-30

#### MATERIAL

100% poliéster

#### EMBALAGEM

1 peça

P  21202

P  21208

P  21212

M  -

M  21209

M  21213

G  -

G  21210

G  -

FOTOS MERAMENTE ILUSTRATIVAS. AS INFORMAÇÕES/CONFIGURAÇÕES DE PRODUTOS PODERÃO SOFRER ALTERAÇÕES SEM AVISO PRÉVIO.

ENTRE EM CONTATO COM O SEU CONSULTOR OU FALE COM O NOSSO TIME DE TELEVENDAS PELO (33) 3277-3030.



# PRODUTOS EM LIQUIDAÇÃO



## RAVA



### Bermuda Pro Line Rava

#### CARACTERÍSTICA

Microfilamento poliéster + elastano  
Forro: D-40

#### PROTEÇÃO

UV-30

#### EMBALAGEM

1 peça

P  21193

P  21196

P  21199

FOTOS MERAMENTE ILUSTRATIVAS. AS INFORMAÇÕES/CONFIGURAÇÕES DE PRODUTOS PODERÃO SOFRER ALTERAÇÕES SEM AVISO PRÉVIO.

ENTRE EM CONTATO COM O SEU CONSULTOR OU FALE COM O NOSSO TIME DE TELEVENDAS PELO (33) 3277-3030.

# PRODUTOS EM LIQUIDAÇÃO

## RAVA



### Bermuda Ride Line Rava

#### CARACTERÍSTICA

Bermuda esportiva | Possui ótimo ajuste ao corpo garantindo conforto e elasticidade para prática de ciclismo

Possui bolso lateral | Confeccionada também com lycra dupla na barra gerando maior conforto e liberdade de movimento durante a prática do exercício

Forro com densidade D-40 de espuma com ação antibacteriana

#### PROTEÇÃO

UV-50

#### MATERIAL

94% poliéster e 6% elastano

#### EMBALAGEM

1 peça

P  21174

P  21185

P  21189

FOTOS MERAMENTE ILUSTRATIVAS. AS INFORMAÇÕES/CONFIGURAÇÕES DE PRODUTOS PODERÃO SOFRER ALTERAÇÕES SEM AVISO PRÉVIO.

ENTRE EM CONTATO COM O SEU CONSULTOR OU FALE COM O NOSSO TIME DE TELEVENDAS PELO (33) 3277-3030.





# PRODUTOS EM LIQUIDAÇÃO



## RAVA



### Capacete MTB Rava Space 3 | Brilho

<b>CARACTERÍSTICA</b>	In Mold   Regulável   Viseira
<b>ENGATE</b>	Sistema de engate em "Y"
<b>VENTILAÇÃO</b>	18 canais de ventilação
<b>PESO APROXIMADO</b>	180 g
<b>EMBALAGEM</b>	10 peças

#### TAMANHO MÉDIO: 54-58

1		16080
3		16078
4		16083
5		16082
6		16081
7		16077

#### TAMANHO GRANDE: 57-61

2		-
3		-
4		16075
5		16074
6		16073
7		16069

FOTOS MERAMENTE ILUSTRATIVAS. AS INFORMAÇÕES/CONFIGURAÇÕES DE PRODUTOS PODERÃO SOFRER ALTERAÇÕES SEM AVISO PRÉVIO.

ENTRE EM CONTATO COM O SEU CONSULTOR OU FALE COM O NOSSO TIME DE TELEVENDAS PELO (33) 3277-3030.

# PRODUTOS EM LIQUIDAÇÃO

## RAVA

### Capacete Little Child Rava Play

**CARACTERÍSTICA** Tamanho único 56 cm

**EMBALAGEM** 50 peças

2  15472



### Capacete com kit proteção Little Child Rava Play

**CARACTERÍSTICA** Tamanho único 56 cm | Acompanha kit de proteção

**KIT PROTEÇÃO** Par de joelheiras | Par de cotoveleiras | Par de munhequeiras

**EMBALAGEM** 40 peças



-



15481



-

FOTOS MERAMENTE ILUSTRATIVAS. AS INFORMAÇÕES/CONFIGURAÇÕES DE PRODUTOS PODERÃO SOFRER ALTERAÇÕES SEM AVISO PRÉVIO.

ENTRE EM CONTATO COM O SEU CONSULTOR OU FALE COM O NOSSO TIME DE TELEVENDAS PELO (33) 3277-3030.



### Caramanhola Pivot Smart Rava

#### CARACTERÍSTICA

Flexível para apertar | BPA free | Tampa Inteligente ( abre e fecha) | Bico removível para limpeza | Boca larga (facilita a limpeza e abastecimento)

#### CAPACIDADE

560 ml

#### TAMANHO

ø 7 cm | Altura: 20 cm

#### EMBALAGEM

01 peça

1  14711

2  14712



### Caramanhola Fast Rava

#### CARACTERÍSTICA

Flexível para apertar | Tampa Inteligente ( abre e fecha) | Bico removível para limpeza | Boca larga (facilita a limpeza e abastecimento) | BPA free | Alça de transporte

#### CAPACIDADE

650 ml

#### TAMANHO

ø 7 cm | Altura: 24 cm

#### EMBALAGEM

01 peça

1  14728

2  14729



# PRODUTOS EM LIQUIDAÇÃO



## RAVA



### Suporte para Caramanhola Rava

<b>MATERIAL</b>	Nylon
<b>OBSERVAÇÃO</b>	Parafusos não inclusos
<b>EMBALAGEM</b>	100 peças
	13135

### Selim MTB Pictoris Rava

<b>MODELO</b>	MTB
<b>TRILHO</b>	Aço
<b>TAMANHO</b>	275x133 mm
<b>PESO</b>	396g
<b>EMBALAGEM</b>	25 peças



12594



FOTOS MERAMENTE ILUSTRATIVAS. AS INFORMAÇÕES/CONFIGURAÇÕES DE PRODUTOS PODERÃO SOFRER ALTERAÇÕES SEM AVISO PRÉVIO.

ENTRE EM CONTATO COM O SEU CONSULTOR OU FALE COM O NOSSO TIME DE TELEVENDAS PELO (33) 3277-3030.

# PRODUTOS EM LIQUIDAÇÃO

## RAVA



### Protetor de Quadro RAVA

MATERIAL

EMBALAGEM 1 peça

 11497



### Boné Rava

CARACTERÍSTICA Fecho de velcro

MATERIAL 100% poliéster

EMBALAGEM 50 peças

FATOR 5

15148

FOTOS MERAMENTE ILUSTRATIVAS. AS INFORMAÇÕES/CONFIGURAÇÕES DE PRODUTOS PODERÃO SOFRER ALTERAÇÕES SEM AVISO PRÉVIO.

ENTRE EM CONTATO COM O SEU CONSULTOR OU FALE COM O NOSSO TIME DE TELEVENDAS PELO (33) 3277-3030.

# KIT pressure 12v

COLIGADA 6



29"  
WHEELS

Urbana

Alumínio

Mega Over

12 velocidades

Disco Hidráulico

### QUADRO

Quadro Rava MTB Pressure 29" | Caixa central BSA 68 mm | Suporte de Freio Standard | Eixo traseiro 135 mm x 9 mm | Largura do pneu 2.20 (com cravos baixos) | Alumínio 6061 | Cabeamento da marcha interno | Direção Mega Over semi-integrada caixa 44 mm | Tubo do canote 27.2 mm |

### SUSPENSÃO DIANTEIRA

Suspensão TSW | Eixo de 9 mm | Ahead set | Trava Remota | OLD 100mm | Kraw alumínio | Lower Leg de aço

### SUSPENSÃO TRASEIRA

N/A

### MOVIMENTO DE DIREÇÃO

Direção Mega Over | Semi-integrada | Esferada

### GUIDÃO

X-Time | Alumínio | Reto | 31.8 x 740 mm | 9° backsweep

### SUPORTE DE GUIDÃO

X-Time | Ahead | Alumínio | 31.8 x 90 mm | +/-7°

### MANOPLA

MTB | Preta

### CONJUNTO DE FREIO

X-Time | Hidráulico | Abraçadeira | Reservatório de alumínio | Óleo mineral | Caliper 2 pistões

### DISCO DE FREIO

X-Time | 160 mm | 06 parafusos | Aço

### ARO/RAIO

Rava | Alumínio 6063 | 622x19mm | ERD 584 mm | Parede dupla | 32F | Raio preto

### CUBOS

Cubo X-Time | Rolamentado | Alumínio | Bloccagem | Freehub standard | 32 furos

### PNEU / CÂMARA DE AR

Pneu: Arisun Skinwall Mount Bona 29x2.10 | Câmara: Arisun 29" | Válvula americana

### PEDIVELA

X-Time Ponta Quadrada | Single | Coroa 32D | Aço | Braço Alumínio | BCD 104mm

### CORRENTE

Corrente 12S | SUMC/xtime | Missing link / Power Link

### EIXO CENTRAL

34.7 x 110 mm | Ponta Quadrada | Aço | Rolamentos

### CASSETTE

X-TIME | Index | 12 velocidades | Aranha dos Cogs superiores de alumínio | 11/52D. (11-13-15-18-21-23-26-30-34-40-46-52)

### CÂMBIO DIANTEIRO

N/A

### CÂMBIO TRASEIRO

XTIME 12V | Roldanas 12D. | Corpo em Alumínio | Cage de Aço | Guia do Caço de Nylon | Tecnologia U-Pulley (onde um dente é maior que o outro para melhor encaixe na corrente)

### ALAVANCA

XTIME 12V. | Alumínio/ Plástico

### SELIM

Rava MTB | Trilho de aço | Vazado

### CANOTE

X-Time | Alumínio | 27.2 x 350 mm | Carrinho | Parafuso único

### ABRAÇADEIRA

X-Time | Alumínio | 31.8 | Bloccagem

### PEDAL

Inglês | Preto | Nylon

### URBANA

✓

### CICLOTURISMO

X

### TRILHAS

X

### 29" IMPORTADA

15.5 ■ 20477

17 ■ 20478

19 ■ 20479

# PRODUTOS EM LIQUIDAÇÃO

## RAVA



### KIT Quadro Mtb Nazca

<b>MODELO</b>	29"   Boost 148mm x 12mm   Cabeamento interno   Dois suportes de caramanhola
<b>DIREÇÃO</b>	Tapared semi-integrada (44 x 55mm)
<b>CANOTE</b>	Diâmetro 31.6mm Passagem de cabo para canote retrátil
<b>FREIO</b>	Suporte de freio traseiro Post Mount dentro do Chainstay
<b>MOVIMENTO CENTRAL</b>	BSA 34.7 x 73mm
<b>EIXO</b>	Eixo traseiro m12 x 1.5mm - 170mm
<b>PNEU</b>	Diâmetro máximo 2.40 (60-622) cravos baixos
<b>MATERIAL</b>	Alumínio 6061
<b>PESO</b>	1.970g ("M" incluindo eixo e acessórios)

#### LIMITE DE COROA

Este modelo de quadro é apenas para uma coroa.

AZUL/CINZA	VERMELHO/CINZA	CINZA	CINZA/VERMELHO F
15.5  22791	15.5  22790	15.5  22792	15.5  22793
17  -		17  -	



### KIT Trava

#### CARACTERÍSTICA

Botão da Trava  
Suspensão Rock Shox  
Poploc Esquerda 17mm  
| Compatível com qualquer suspensão Rock Shox como: XC30 - Recon - XC 32 - Reba - XC 28 - Judy | Acompanha cabos e conduites para montagem | Puxar 17 mm

#### MATERIAL

Alumínio

#### PESO

69 gr

#### EMBALAGEM

20 peças

### KIT Garfo Judy

#### CARACTERÍSTICA

Garfo Suspensão Rock Shox Judy 29" | Curso 100 mm | Trava Remota | Ajuste de Preload | Off set 46 mm | OLD 100 mm | Eixo 9 mm | Espiga Tapered (26.5cm) | Diâmetro Máximo do Pneu 755 mm | Largura Máxima do Pneu 62 mm | Tamanho Máximo do Rotor 185mm | Tamanho mínimo do rotor 160 mm | Trava PopLoc Remote (puxador de cabo de 17 mm) | Sistema de fixação do Caliper Post Mount.

#### MATERIAL

Alumínio e Aço

#### PESO

2.328 gr

#### EMBALAGEM

1 peça

### KIT de Montagem

#### GUIDÃO

X-Time | Reto | 720 x 31.8 mm | 9° backsweep | Alumínio

#### SUPORTE DE GUIDÃO

X-Time | Ahead set | 90 x 31.8 mm / 7° | Alumínio

#### CANOTE

X-Time | 31.6 x 350 mm | Parafuso único | Alumínio

#### ABRACADEIRA

X-Time | Blocação | 34.9 mm | Alumínio

#### EMBALAGEM

20 pçs

### KIT Movimento de Direção Super Over Ahead

#### CARACTERÍSTICA

Ahead Set Tapered | Direção 1 1/8x44mm | Integrado (c/ caixas)

#### MODELO

Com adaptador para garfo 30mm e 39.8mm

#### EXTENSÃO

1.5x1.1/8

FOTOS MERAMENTE ILUSTRATIVAS. AS INFORMAÇÕES/CONFIGURAÇÕES DE PRODUTOS PODERÃO SOFRER ALTERAÇÕES SEM AVISO PRÉVIO.

ENTRE EM CONTATO COM O SEU CONSULTOR OU FALE COM O NOSSO TIME DE TELEVENDAS PELO (33) 3277-3030.

# PRODUTOS EM LIQUIDAÇÃO

## RAVA



### QUADRO 29" RAVA RAGE CARBON

**MODELO** 29" | Rava RAGE CARBON | Boost 148mm  
Cabeamento interno | Suporte para câmbio dianteiro/ guia de corrente direct mount

**DIREÇÃO** Integrada (42MM X 52MM)

**CANOTE** Diâmetro do tubo 31.6 mm | Acompanha abraçadeira do tubo do canote

**FREIO** Suporte de freio traseiro post mount dentro do chainstay

**MOVIMENTO CENTRAL** Press Fit | 41 x 92 mm

**EIXO** Acompanha eixo traseiro Boost

**PNEU** Largura máxima 29" x 2.35

**MATERIAL** Carbono

**PESO MÁXIMO SUPORTADO** 100kg

**PESO** 1.357g (Peso referente ao quadro 17" com abraçadeira, gancheira e eixo traseiro)

**EMBALAGEM** 1 unidade

#### CINZA/VERMELHO

17  22116

19  22117

#### CINZA

15.5  22118

17  22119

19  22120

FOTOS MERAMENTE ILUSTRATIVAS. AS INFORMAÇÕES/CONFIGURAÇÕES DE PRODUTOS PODERÃO SOFRER ALTERAÇÕES SEM AVISO PRÉVIO.

ENTRE EM CONTATO COM O SEU CONSULTOR OU FALE COM O NOSSO TIME DE TELEVENDAS PELO (33) 3277-3030.





### Castanha de Selim Completa

#### CARACTERÍSTICA

Castanha de selim Rava | Aço de alta resistência preto | Eixo quadrado com duas porcas e dois conjuntos de abraçadeiras laterais para ua melhor fixação ao selim

#### MATERIAL

Aço

#### PESO

146 gr

#### EMBALAGEM

50 peças

22693

# ABASTEÇA SEU ESTOQUE



**metz**



# PRODUTOS EM LIQUIDAÇÃO



## metz



### PRETO/VERMELHO

15.5  19381

17  19384

19  19385



### PRETO/VERDE

15.5  19386

17  19387

19  19388



### PRETO/ROSA

17  19390



## Quadro Metz Fuse 29"

**DIREÇÃO** Mega Over de 44 mm

**CANOTE** 27.2 mm

**FREIO** Disc brake IS (international Standard)

**TUBO MOVIMENTO CENTRAL** BSA 68 mm

**MOVIMENTO CENTRAL** 34.7 mm

**MATERIAL** Alumínio

**ACABAMENTO** Adesivo não envernizado

**PESO** 1.82 kg (17")

**EMBALAGEM** 2 peças

FOTOS MERAMENTE ILUSTRATIVAS. AS INFORMAÇÕES/CONFIGURAÇÕES DE PRODUTOS PODERÃO SOFRER ALTERAÇÕES SEM AVISO PRÉVIO.

ENTRE EM CONTATO COM O SEU CONSULTOR OU FALE COM O NOSSO TIME DE TELEVENDAS PELO (33) 3277-3030.

# ABASTEÇA SEU ESTOQUE



**X-TIME**



### Conjunto Câmbio X-TIME 12V | Modelo 2

<b>CARACTERÍSTICAS</b>	Conjuntos de transmissão de 1x12 velocidades de alta precisão e durabilidade.
<b>CASSETE</b>	X-TIME Index 12 velocidades   11/52 dentes (11-13-15-18-21-23-26-30-34-40-46-52) possui mudança estável e suave   Melhor performance e eficiência   Encaixe padrão Shimano K7   Aranha os últimos COGS de alumínio. Peso: 721 g
<b>CÂMBIO TRASEIRO</b>	X-TIME 12 velocidades   Mais resistência e segurança na fixação   Roldanas com 12 dentes   Rolamento selado sistema de dentes U-Pulley (onde um dente é maior que o outro para melhor encaixe na corrente). Peso: 314 g
<b>ALAVANCAS</b>	X-TIME 12 velocidades   Estrutura em alumínio e acabamento plástico   Regulador de tenção   Acompanha cabo de aço (cabo de aço comum NÃO é inox). Na mesma alavanca pode-se efetuar a descida e subida das marchas impulsionando com o polegar. Peso: 144 g
<b>CORRENTE</b>	X-TIME Index de 12 velocidades   128 links   Cromada   Acompanha emenda de engate rápido (Power Link). Peso: 269 g
<b>PEDIVELA</b>	X-TIME 12 velocidades   Single   Alumínio Braço: 170 mm Coroa: Direct Mount Chainring 32 T   3 mm offset   Alumínio Eixo: 120 x 24 mm (padrão Hollowtech II)   Aço Eixo do pedal: 9/16 Inglês Acompanha movimento central Peso: 879 g (completo com movimento central)
<b>EMBALAGEM</b>	10 kits (caixa fechada) Kit com 6 peças (incluindo movimento central)

19152

### Engrenagem Dupla com Braço 36/22

**CARACTERÍSTICA** Engrenagem dupla | Braço de alumínio com 170mm | Coroa 36/22D | Fixas de aço | Sistema de encaixe compatível com eixo central ponta quadrada | Diâmetro da rosca do pedal 9/16 (inglês) | Preto

**MATERIAL** Braço: Alumínio | Rosca do pedal: 9/16 | Coroa 36/22D: aço

**CONJUNTO DE COROA** 36/22D

**COMPRIMENTO DO BRAÇO** 170 mm

**PESO** 686 gr

**EMBALAGEM** 10 peças

20504



### Engrenagem Tripla

**CARACTERÍSTICA** Engrenagem tripla | Braço de alumínio com 170mm | Coroa 40/30/22D fixadas por parafusos | Sistema de encaixe compatível com eixo central ponta quadrada | BCD 96/64mm | Diâmetro da rosca do pedal 9/16 Inglês

**MATERIAL** Braço: alumínio | Coroa 40D: alumínio | Coroa 30/22D: aço

**TAMANHO DO BRAÇO** 170 mm

**CONJUNTO DE COROA** 40/30/22D

**MEDIDA DO BCD** 69 mm / 64 mm

**EMBALAGEM** 10 peças

**PESO** 794 gr

20476



### Engrenagem Tripla 24/34/42D

CARACTERÍSTICA	Com braço 170mm compatível com eixo ponta quadrada
BCD	-
MATERIAL	-
COROA	Aço
EMBALAGEM	12 peças
130 MM	20107



### Engrenagem Direct Single Avulsa MTB Off Set 6 mm

CARACTERÍSTICA	Compatível com Sram®, Direct mount, Off set 3 mm
MATERIAL	Alumínio 7075
DENTES	30 D, 32 D, 34 D
MEDIDA DO BCD	69 mm / 64 mm
EMBALAGEM	10 peças
PESO	30 – 57g   32 – 63g   34 – 66g
30 D	13152



### Engrenagem Direct Single Avulsa MTB Off Set 3 mm

CARACTERÍSTICA	Direct mount   Compátível com Sram®
MATERIAL	Alumínio 7075
ENGENHAGENS	30   32   34 D
PESO	30 - 57 g 32 - 63 g 34 - 66 g
EMBALAGEM	10 peças
30D	-
32D	13150

FOTO ILUSTRATIVA  
DA EMBALAGEM



### Engrenagem Direct Single Avulsa MTB Off Set 0 mm

CARACTERÍSTICA	Direct mount   Compátível com Sram®
MATERIAL	Alumínio 7075
ENGENHAGENS	30   32   34 D
PESO	30 - 57 g 32 - 63 g 34 - 66 g
EMBALAGEM	10 peças
30D	13144

FOTO ILUSTRATIVA  
DA EMBALAGEM





### Engrenagem Avulsa Pedivela Triplo MTB

CARACTERÍSTICA	Material de alta resistência e rigidez, proporciona conforto e estabilidade ao pedalar
MATERIAL	Aço
ENGENHAGENS	40/30/22D
BCD	96mm
PESO	40D - 70 g 30D - 61 g 22D - 49 g
EMBALAGEM	1 peça
40D	-
22D	07780

FOTO ILUSTRATIVA DA EMBALAGEM



### Cog Avulsa 40/42v MTB

CARACTERÍSTICA	Material de alta resistência e rigidez, proporciona conforto e estabilidade ao pedalar
MATERIAL	Alumínio 7075
ENGENHAGENS	40/42D
PESO	40 - 61g 42 - 70g
EMBALAGEM	1 peça
40D	07724

FOTO ILUSTRATIVA DA EMBALAGEM



### Cassete 10v Index

CARACTERÍSTICA	Cassete 10V   11/36 Dentes   Estrutura em aço   Padrão Standard
ESCALONAMENTO	11/13/15/17/19/21/24/28/32/36T
MATERIAL	Aço de alta resistência
EMBALAGEM	25 peças
PESO	455 gr

20506



### Roda Livre 7v Index Bronze

CARACTERÍSTICA	Roda livre 7V   14/28 dentes   Estrutura em aço   Fixação por rosca   Escalonamento 14/16/18/20/22/24/28 T
MATERIAL	Aço de alta resistência
EMBALAGEM	50 peças
PESO	424 gr

20513



### Cubo Dianteiro X-Time 36 furos

CARACTERÍSTICA	Freio a disco 6 parafusos   Eixo furado com blocagem   Rolamento 6200rs
O.L.D	100 mm
MATERIAL	Alumínio   Eixo de aço furado
PESO	335 g
EMBALAGEM	50 peças

19134





### Eixo Dianteiro 3/8

**CARACTERÍSTICA** 3/8 aço zincado completo com caixas, colares com esferas, porcas e contra-porcas | Medidas: Eixo 145mm x 9.5mm | Colar com Esferas 3/16 | Caixas com batentes 24.4mm de diâmetro e 10mm largura externa

**MATERIAL** Aço

**PESO** 156 gr

**EMBALAGEM** 50 peças

19128



### BLOCAGEM Eixo Dianteiro X-Time

**CARACTERÍSTICA** Blocagem de eixo dianteiro | Preto | 1 alavanca com haste e molas | Compatível com cubos: freio a disco ou V-brake de eixo furado padrão 9 mm

**ALAVANCAS** Alumínio

**HASTE** Aço

**COMPRIMENTO** Dianteira 130 mm

**PESO** 45 gr

**EMBALAGEM** 50 peças

20469

### Blocagem de Eixo Dianteiro

CARACTERÍSTICA	Alavancas: Alumínio   Haste: Aço   Preto   Alavanca com haste e molas
COMPRIMENTO	Dianteira 140mm
COMPATIBILIDADE	Cubos Freio a Disco ou V-brake de eixo furado padrão 9mm
MATERIAL	Aço/alumínio
PESO	46 gr
EMBALAGEM	50 peças

22715



### Guidão X-Time SPEED - 440 MM

MATERIAL	Alumínio
TAMANHO	440 x 31.8 mm
PESO APROXIMANDO	397g
EMBALAGEM	50 peças

16942





### Guidão alum. Mtb 31.8mm **RETO** PT XT

MATERIAL	Alumínio
TAMANHO	740 x 31.8 mm
BACKSWEEP	9°
PESO APROXIMADO	296 g
EMBALAGEM	15 peças
	22750



### Suporte de Guidão 100 mm/7° **X-Time**

CARACTERÍSTICA	Ahead Set
MATERIAL	Alumínio
TAMANHO	100 x 31.8 mm / 7°
PESO APROXIMANDO	180g
EMBALAGEM	50 peças
	16948

### Movimento direção esf. Tapered garfo 30mm e 39.8mm preto

**CARACTERÍSTICA** Movimento direção tapered  
Esferada  
Caixa de aço  
Acabamento superior em alumínio  
Acompanha aranha  
Cones de aço  
Caixa superior ø44mm  
Caixa inferior ø56mm

**MATERIAL** Aço

**EMBALAGEM** 50 peças

**PESO** 156g

**CÓDIGO:** 22804



### Suporte de Guidão 90 mm/7° X-Time

**CARACTERÍSTICA** Ahead Set

**MATERIAL** Alumínio

**TAMANHO** 90 x 31.8 mm / 7°

**PESO APROXIMANDO** 176g

**EMBALAGEM** 50 peças

16947



### Suporte de Guidão com ajuste de ângulo X-Time

CARACTERÍSTICA	Ângulação Regulável 30°/-30°   Parafuso expander (Allen)
MATERIAL	Alumínio
TAMANHO	90 x 25.4 mm
PESO APROXIMANDO	494g
EMBALAGEM	50 peças

18053 OU 17868



### Abraçadeira X-Time - BK

CARACTERÍSTICA	Com Blocação
MATERIAL	Alumínio
TAMANHO	31.8 mm   34.9 mm
PESO APROXIMANDO	45 g
EMBALAGEM	200 peças

34.9 MM 16960/ 22755



34.9 MM

### Conduíte para freio

CARACTERÍSTICA	Com teflon
COMPRIMENTO	20 m
ESPESSURA	5 mm
EMBALAGEM	500 peças

14161





# PRODUTOS EM LIQUIDAÇÃO



## X-TIME

### Cabo para freio traseiro extra light

CARACTERÍSTICA 19 Fios | Extra light | Traseiro

EMBALAGEM 500 peças

14143



### Fita demarcação X-TIME

EMBALAGEM 200 mts (aproximado)

09817



FOTOS MERAMENTE ILUSTRATIVAS. AS INFORMAÇÕES/CONFIGURAÇÕES DE PRODUTOS PODERÃO SOFRER ALTERAÇÕES SEM AVISO PRÉVIO.

ENTRE EM CONTATO COM O SEU CONSULTOR OU FALE COM O NOSSO TIME DE TELEVENDAS PELO (33) 3277-3030.



### Suporte Caramanhola X-Time Nylon

**CARACTERÍSTICA** Material Nylon  
Alta qualidade  
Leve  
Resistente  
Excelente acabamento  
Fixação por dois parafusos  
(acompanha o suporte)

**PESO** +- 35 gr

**MATERIAL** Nylon

**EMBALAGEM** 10 peças

 23210

 23211

 -

 23213

 -

 23215





# PRODUTOS EM LIQUIDAÇÃO



## X-TIME



### Caramanhola X-Time Fast

#### CARACTERÍSTICA

Flexível para apertar | Tampa Inteligente ( abre e fecha) | Bico removível para limpeza | Boca larga (facilita a limpeza e abastecimento) | BPA free | Alça de transporte

#### CAPACIDADE

650 ml

#### TAMANHO

ø 7 cm | Altura: 24 cm

#### EMBALAGEM

01 peça

1  14730

2  14731



### Caramanhola X-Time Pivot | Smart

**CARACTERÍSTICA** Flexível para apertar | BPA free |  
Tampa Inteligente ( abre e fecha )  
| Bico removível para limpeza |  
Boca larga (facilita a limpeza e  
abastecimento)

**CAPACIDADE** 560 ml

**TAMANHO** ø 7 cm | Altura: 20 cm

**EMBALAGEM** 01 peça

1  14713

2  14714





# PRODUTOS EM LIQUIDAÇÃO



## X-TIME



### Display X-Time Lube

CARACTERÍSTICA	4 bandejas 500 x 400 mm
PESO SUPORTADO	120 kg
MATERIAL	Plástico
EMBALAGEM	1 peça
	13722

\*Imagens meramente ilustrativas, produtos não inclusos.

FOTOS MERAMENTE ILUSTRATIVAS. AS INFORMAÇÕES/CONFIGURAÇÕES DE PRODUTOS PODERÃO SOFRER ALTERAÇÕES SEM AVISO PRÉVIO.

ENTRE EM CONTATO COM O SEU CONSULTOR OU FALE COM O NOSSO TIME DE TELEVENDAS PELO (33) 3277-3030.

PRODUTOS EM LIQUIDAÇÃO

X-TIME



\*Imagens meramente ilustrativas, produtos não inclusos.

### Display para balcão X-Time Lube

CARACTERÍSTICA 1 bandeja 480 x 290 mm

MATERIAL Plástico

EMBALAGEM 1 peça

13721

FOTOS MERAMENTE ILUSTRATIVAS. AS INFORMAÇÕES/CONFIGURAÇÕES DE PRODUTOS PODERÃO SOFRER ALTERAÇÕES SEM AVISO PRÉVIO.

ENTRE EM CONTATO COM O SEU CONSULTOR OU FALE COM O NOSSO TIME DE TELEVENDAS PELO (33) 3277-3030.

# PRODUTOS EM LIQUIDAÇÃO

## X-TIME

### Graxa Sintética Azul



CARACTERÍSTICA	Resistente a água e a atritos, não contém lítio e não resseca plásticos nem borrachas
COMPOSIÇÃO	Graxa sintética, hidrocarboneto hidrogenado de grau farmacêutico e corantes, anticorrosivos e conservante
EMBALAGEM	20 peças (100g)   12 peças (500g)
500 G	15443
100 G	15442



### Graxa Grip



CARACTERÍSTICA	Apresenta longa vida útil, é resistente a água, não contém lítio e também não agride peças de fibra de carbono, plásticos ou borrachas
COMPOSIÇÃO	Polímero sintético, óleo sintético de média viscosidade, óleo mineral purificado por hidrogenação com altíssimo grau de pureza, agente antidesgaste, óxido inorgânico e corante
EMBALAGEM	20 peças (100g)   12 peças (500g)
100 G	15444
500 G	15445



### Graxa Branca

CARACTERÍSTICA	Especialmente desenvolvida para caixas de direção, rolamentos, engrenagens, cubos, movimentos centrais Hollowtech, BB30 e similares
COMPOSIÇÃO	Óleo de base mineral, sabão de lítio, aditivos e corantes
EMBALAGEM	50 peças
200 G	13045



FOTOS MERAMENTE ILUSTRATIVAS. AS INFORMAÇÕES/CONFIGURAÇÕES DE PRODUTOS PODERÃO SOFRER ALTERAÇÕES SEM AVISO PRÉVIO.

ENTRE EM CONTATO COM O SEU CONSULTOR OU FALE COM O NOSSO TIME DE TELEVENDAS PELO (33) 3277-3030.

## X-TIME



### Boné X-Time

CARACTERÍSTICA	Fecho de velcro
MATERIAL	100% poliéster
EMBALAGEM	50 peças
FATOR	5

15146



### Boné X-Time Lube

CARACTERÍSTICA	Fecho de velcro
MATERIAL	100% poliéster
EMBALAGEM	50 peças
FATOR	5

15147



### Alavanca de Câmbio 27v MTB S9

**CARACTERÍSTICA** Estrutura em alumínio  
visor indicador de posição

**PESO APROXIMADO** 309 g

**EMBALAGEM** 1 peça

08177



## S10

### Câmbio Dianteiro 20v MTB S10

**CARACTERÍSTICA** estrutura em alumínio com anel duplo  
para dar mais resistência e segurança na  
fixação

**PESO APROXIMADO** 161 g

**EMBALAGEM** 1 peça

10849/20466



### Câmbio Traseiro 20v MTB S10

**CARACTERÍSTICA** Compatível com várias combinações  
de engrenagens até 11-42D

**PESO APROXIMADO** 336 g

**EMBALAGEM** 1 peça

10848/20507







# PRODUTOS EM LIQUIDAÇÃO



## X-TIME



### Alavanca de Câmbio 20v MTB S10

CARACTERÍSTICA	Estrutura em alumínio visor indicador de posição
PESO APROXIMADO	317 g
EMBALAGEM	1 peça
	10847/20508



### Alavanca de câmbio 27 v. MTB S9

CARACTERÍSTICA	Com visor indicador de posição
PESO APROXIMADO	312 g
MATERIAL	Alumínio
EMBALAGEM	1 peça
	22703



### Cassete 8v MTB S8

CARACTERÍSTICA	Mudança estável e suave, melhor performance e eficiência
CASSETE	12/14/17/19/21/24/28/32D
PESO APROXIMADO	341 g
EMBALAGEM	10 peças
	08186

FOTOS MERAMENTE ILUSTRATIVAS. AS INFORMAÇÕES/CONFIGURAÇÕES DE PRODUTOS PODERÃO SOFRER ALTERAÇÕES SEM AVISO PRÉVIO.

ENTRE EM CONTATO COM O SEU CONSULTOR OU FALE COM O NOSSO TIME DE TELEVENDAS PELO (33) 3277-3030.



### Prolongador de Gancheira MTB e SPEED

<b>CARACTERÍSTICA</b>	Medidas 45mm x 11.5mm   Parafuso M10 X 1.0   Instalação com auxílio de chave allen 6mm
<b>MATERIAL</b>	Alumínio
<b>EMBALAGEM</b>	50 peças 10776



### Prolongador de Gancheira Modelo 02

<b>COMPATIBILIDADE</b>	X-time RDS, RXS, Shimano
<b>MATERIAL</b>	Alumínio
<b>EMBALAGEM</b>	02 peças 12911/20468

### Conjunto Transmissão 8v MTB S8

<b>CARACTERÍSTICA</b>	Conjuntos de transmissão de 8 velocidades de alta precisão e durabilidade
<b>CÂMBIO DIANTEIRO</b>	Estrutura em alumínio com anel duplo para dar mais resistência e segurança na fixação Peso aproximado 145 g
<b>CASSETTE</b>	12/14/17/19/21/24/28/32D Mudança estável e precisa Peso aproximado 336 g
<b>CÂMBIO TRASEIRO</b>	Compatível com várias combinações de engrenagens Peso aproximado 315 g
<b>ALAVANCAS</b>	Estrutura em alumínio Visor indicador de posição Peso aproximado 306 g
<b>EMBALAGEM</b>	1 conjunto

07142

FOTO ILUSTRATIVA  
DA EMBALAGEM



### Conjunto Transmissão 9v MTB S9

<b>CARACTERÍSTICA</b>	Conjuntos de transmissão de 9 velocidades de alta precisão e durabilidade
<b>CÂMBIO DIANTEIRO</b>	Estrutura em alumínio com anel duplo para dar mais resistência e segurança na fixação Peso aproximado 148 g
<b>CASSETTE</b>	11/13/15/17/21/24/28/32/36D Mudança estável e precisa Peso aproximado 441 g
<b>CÂMBIO TRASEIRO</b>	Compatível com várias combinações de engrenagens Peso aproximado 315 g
<b>ALAVANCAS</b>	estrutura em alumínio visor indicador de posição Peso aproximado 309 g
<b>EMBALAGEM</b>	1 conjunto

07141

FOTO ILUSTRATIVA DA EMBALAGEM





# PRODUTOS EM LIQUIDAÇÃO



## X-TIME



### Conjunto Câmbio X-TIME S12

<b>CARACTERÍSTICA</b>	Conjuntos de transmissão de 1x12 velocidades de alta precisão e durabilidade
<b>CASSETTE</b>	X-TIME Index 12 velocidade 11/52 dentes (11-13-15-18-21-23-26-30-34-40-46-52) possui mudança estável e suave, melhor performance e eficiência, encaixe padrão shimano K7 Peso: 721g
<b>CÂMBIO TRASEIRO</b>	X-TIME 12 velocidades; mais resistência e segurança na fixação   Roldanas com 12 dentes rolamento selado sistema de dentes U-Pulley (onde um dente é maior que o outro para melhor encaixe na corrente) Peso: 311g
<b>ALAVANCAS</b>	X-TIME 12 velocidades estrutura em alumínio e acabamento plástico, regulador de tenção e acompanha cabo de aço (cabo de aço comum NÃO é inox). Na mesma alavanca pode-se efetuar a descida e subida das marchas impulsionando com o polegar Peso: 144g
<b>EMBALAGEM</b>	10 peças

19151

FOTOS MERAMENTE ILUSTRATIVAS. AS INFORMAÇÕES/CONFIGURAÇÕES DE PRODUTOS PODERÃO SOFRER ALTERAÇÕES SEM AVISO PRÉVIO.

ENTRE EM CONTATO COM O SEU CONSULTOR OU FALE COM O NOSSO TIME DE TELEVENDAS PELO (33) 3277-3030.



## X-TIME

### Câmbio Dianteiro 24v MTB S8

**CARACTERÍSTICA** Estrutura em alumínio com anel duplo para dar mais resistência e segurança na fixação

**PESO APROXIMADO** 145 g

**EMBALAGEM** 1 peça

08182 / 16732



## S9

### Câmbio Traseiro 27v MTB S9

**CARACTERÍSTICA** Compatível com várias combinações de engrenagens

**PESO APROXIMADO** 315 g

**EMBALAGEM** 1 peça

08178



# ABASTEÇA SEU ESTOQUE



QUEST

## QUEST



### Guidão Rise Bar | Linha Quest

<b>MATERIAL</b>	Carbono (UD Matt Carbon Fiber t800)	<b>RISE</b>	20 mm
<b>TAMANHO</b>	740 x 31.8mm	<b>PESO</b>	156g
<b>UPSWEEP</b>	6°	<b>EMBALAGEM</b>	20 peças
<b>BACKSWEEP</b>	9°		15107

## QUEST

### Garfo 29 rígido mtb ahead alumínio | Linha quest

<b>CARACTERÍSTICA</b>	<ul style="list-style-type: none"><li>• Garfo 29" mtb rígido</li><li>• Marca quest</li><li>• Material alumínio</li><li>• Material da espiga alumínio</li><li>• Old 100mm</li><li>• Eixo 9mm</li><li>• Comprimento da espiga 280mm</li><li>• Diâmetro do espiga 28.6mm over ahead set</li><li>• Suporte de freio post mount</li><li>• Compatível com disco 160mm</li><li>• Acabamento em preto fosco com adesivo laminado</li></ul>
-----------------------	--

**MATERIAL** Alumínio

**PESO** +865gr

**EMBALAGEM** 10 unidades

23226

**AVISOS** Use apenas para:  
• Lazer  
• Cross country



### Garfo 29 rígido mtb taperad alumínio | Linha quest

<b>CARACTERÍSTICA</b>	<ul style="list-style-type: none"><li>• Garfo 29" mtb rígido</li><li>• Marca quest</li><li>• Material alumínio</li><li>• Material da espiga alumínio</li><li>• Espiga tapered (diâmetro superior 28.6mm / diâmetro inferior 39.8mm) 1/8 x 1.5</li><li>• Old 100mm</li><li>• Eixo 9mm</li><li>• Comprimento da espiga 280mm</li><li>• Suporte de freio post mount</li><li>• Compatível com disco 160mm</li><li>• Acabamento em preto fosco com adesivo laminado</li></ul>
-----------------------	--

**MATERIAL** Alumínio

**PESO** +895gr

**EMBALAGEM** 10 unidades

23227

**AVISOS** Use apenas para:  
• Lazer  
• Cross country





## QUEST

### Garfo 29 rígido mtb ahead alumínio boost | Linha quest

#### CARACTERÍSTICA

- Garfo 29" mtb rígido
- Marca quest
- Material alumínio
- Material da espiga alumínio
- Old 110mm
- Eixo 15x110mm com blocagem (acompanha o produto)
- Rosca do eixo 1.5mm
- Comprimento da espiga 280mm
- Diâmetro do espiga 28.6mm over ahead set
- Suporte de freio post mount
- Compatível com disco 160mm
- Acabamento em preto fosco com adesivo laminado

#### MATERIAL

Alumínio

#### PESO

+959gr - peso referente ao e garfo com a blocagem

#### EMBALAGEM

10 unidades

23228

#### AVISOS

Use apenas para:  
• Lazer  
• Cross country



### Garfo 29 rígido mtb taperad alumínio boost | Linha quest

#### CARACTERÍSTICA

- Garfo 29" mtb rígido
- Marca quest
- Material alumínio
- Material da espiga alumínio
- Espiga tapered (diâmetro superior 28.6mm / diâmetro inferior 39.8mm) 1/8 x 1.5
- Old 110mm
- Eixo 15x110mm com blocagem (acompanha o produto)
- Rosca do eixo 1.5mm
- Comprimento da espiga 280mm
- Suporte de freio post mount
- Compatível com disco 160mm
- Acabamento em preto fosco com adesivo laminado

#### MATERIAL

Alumínio

#### PESO

+980gr - peso referente ao e garfo com a blocagem

#### EMBALAGEM

10 unidades

23229

#### AVISOS

Use apenas para:  
• Lazer  
• Cross country



## QUEST

### Garfo 29" MTB com Suspensão Ahead PT | Linha Quest

**CARACTERÍSTICA** Garfo 29" MTB Quest Tapered:  
Garfo em alumínio de alta qualidade  
Canela 34 | Trava Remota no Guidão  
Trava em alumínio com abraçadeira  
Acompanha cabo e conduíte |  
Funcionamento a ar | Suporte do Freio Post  
Mount | Curso de 100mm | Eixo de 9mm  
OLD 100mm | Espiga Tapered ahead set  
(diâmetro superior 28.6mm / diâmetro  
inferior 39.8mm) 1/8 x 1.5 | Comprimento da  
espiga 200mm

**MATERIAL** Alumínio

**PESO** 1868Gr - incluindo trava, cabo e conduíte.

**EMBALAGEM** 10 peças

20830

**AVISOS** Use apenas para:  
• Lazer  
• Cross country



## QUEST

### Garfo 29" MTB com Suspensão Ahead Boost Reb. PT | Linha Quest

**CARACTERÍSTICA** Garfo 29" MTB Quest Boost Tapered | Garfo em alumínio de alta qualidade | Canela 34 Trava Remota no Guidão | Trava em alumínio com abraçadeira | Acompanha cabo e conduíte | Funcionamento a ar | Regulagem de retorno | Suporte do Freio Post Mount | Curso de 100mm | Eixo de 15mm | OLD 110mm | Espiga Tapered ahead set (diâmetro superior 28.6mm / diâmetro inferior 39.8mm) 1/8 x 1.5 | Comprimento da espiga 200mm

**MATERIAL** Alumínio

**PESO** 2070 Gr - incluindo Eixo, trava, cabo e conduíte.

**EMBALAGEM** 10 peças

20831

**AVISOS** Use apenas para:  
• Lazer  
• Cross country



### Garfo 29" mtb com susp. 100mm ahead tap. boost reb PT | Linha quest

**CARACTERÍSTICA** Garfo aro 29" MTB Quest Boost Tapered: Canela 36 | Suporte de freio post mount | Curso total 130mm | Curso de funcionamento 100mm | Crown de alumínio | Espiga alumínio | Comprimento da espiga 200mm | Diâmetro da espiga ø28.6x39.9mm | Funcionamento a ar | Regulagem de rebound Trava remota no guidão | Acionador remoto do guidão em alumínio com abraçadeira | Acompanha cabo e conduíte | Eixo de 15mm (ø15mm / p1.5mm) | Old 110mm

**MATERIAL** Alumínio

**PESO** 2452 Gr

**EMBALAGEM** 10 peças

22788

**AVISOS** Use apenas para:  
• Lazer  
• Cross country



## QUEST

### Garfo 29 mtb c/ susp. 120mm ahead tap. boost reb. PT | Linha quest

**CARACTERÍSTICA** Garfo aro 29" mtb Quest boost tapered Canela 36 | Suporte de freio post mount Curso total 160mm Curso de funcionamento 120mm Crown de alumínio | Espiga alumínio Comprimento da espiga 200mm Diâmetro da espiga ø28.6x39.9mm Funcionamento a ar | Regulagem de rebound Trava remota no guidão Acionador remoto do guidão em alumínio com abraçadeira | Acompanha cabo e conduíte Eixo de 15mm ( ø15mm / p1.5mm) Old 110mm

**MATERIAL** Alumínio

**PESO** +-2390gr

23357

**AVISOS** Use apenas para:  
• Lazer  
• Cross country



### Garfo 29 mtb c/ susp. 120mm ahead boost pt | Linha quest

**CARACTERÍSTICA** • Garfo aro 29" mtb Quest boost • Canela 36 | Suporte de freio post mount • Curso total 160mm • Curso de funcionamento 120mm • Crown de alumínio | Espiga alumínio • Comprimento da espiga 200mm • Diâmetro da espiga ø28.6mm • Funcionamento a ar | Trava remota no guidão • Acionador remoto do guidão em alumínio com abraçadeira • Acompanha cabo e conduíte | Eixo de 15mm ( ø15mm / p1.5mm) | Old 110mm

**MATERIAL** Alumínio

**PESO** 2434gr

**EMBALAGEM** 10 unidades

23358

**AVISOS** Use apenas para:  
• Lazer  
• Cross country



## QUEST

### Garfo 29 mtb c/ susp. 120mm ahead boost reb. PT | Linha quest

#### CARACTERÍSTICA

- Garfo aro 29" mtb Quest boost
- Canela 36 | Suporte de freio post mount
- Curso total 160mm
- Curso de funcionamento 120mm
- Crown de alumínio | Espiga alumínio
- Comprimento da espiga 200mm
- Diâmetro da espiga ø28.6mm
- Funcionamento a ar | Regulagem de rebound
- Trava remota no guidão | Acionador remoto do guidão em alumínio com abraçadeira | Acompanha cabo e conduíte
- Eixo de 15mm (ø15mm / p1.5mm)
- Old 110mm

#### MATERIAL

Alumínio

#### PESO

+2482 Gr

#### EMBALAGEM

10 unidades

23360

#### AVISOS

- Use apenas para:
- Lazer
  - Cross country



## QUEST



### GUIDÃO RETO 6° 800MM C/SUP 2° CRB PT | LINHA QUEST

#### CARACTERÍSTICA

Guidão reto com suporte integrado -2° | linha quest

- Guidão de carbono
- Suporte de guidão integrado de 50mm, 60mm e 70mm
- -2° Negativo

50 MM \_\_\_\_\_ 22240

#### MATERIAL

Material carbono ud  
(ud matt carbon fiber t800)

60 MM \_\_\_\_\_ 22241

#### TAMANHO

• Diâmetro de fixação da espiga 28.6mm  
| • tamanho 800mm

70 MM \_\_\_\_\_ 22242

#### UPSWEEP

6°

#### BACKSWEEP

6°

#### RISE

0

#### PESO

309gr - peso referente ao guidão 60mm

#### EMBALAGEM

15 peças

## QUEST

### SUPORTE CARAMANHOLA CARBONO | LINHA QUEST

**CARACTERÍSTICA** Carbono  
Design Moderno  
Leve e Resistente

**MATERIAL** Carbono

**FIXAÇÃO** 2 Parafusos (não acompanham suporte)

**PESO** 35g

**EMBALAGEM** 50 peças

22248



### SUPORTE CARAMANHOLA MOD.2 CRB | LINHA QUEST

**CARACTERÍSTICA** • Suporte caramanhola  
• Fixação por dois parafusos  
(não acompanham o suporte)

**MATERIAL** Carbono (UD Matt Carbon Fiber t800)

**TAMANHO** • Medidas 14 x 7.2mm

**REMOÇÃO DA GARRAFA** • Remoção da garrafa standard

**PESO** 20g

**EMBALAGEM** 25 peças

22249



## QUEST

### ARO 29" CARBON PAREDE DUPLA LIGHT 28F.

<b>CARACTERÍSTICA</b>	Aro de Carbono Quest Race Q30 SL Super light 28 Furos Carbono T700 E T800 Tubeless Ready Largura interna 30mm Largura Externa 36mm ETRTO RIM SIZE 30-622MM ERD 596MM Altura do aro 22mm Disc Brake Peso máximo do ciclista 110kg Compatível com válvula presta Medidas de pneu de 2,25" a 2,5" Tensão máxima de raio 130kgf Resistência de impacto 80J
-----------------------	---

**FATOR DE VENDA** 1

**EMBALAGEM** 10 unidades

**MATERIAL** Carbono

**PESO** 352gr - peso referente ao par

22929



### ARO 29" CARBON PAREDE DUPLA LIGHT 32F.

<b>CARACTERÍSTICA</b>	Aro de Carbono Quest Race Q30 SL Carbono T700+T800 Super Light SI Acabamento Fosco Largura Interna 30mm Largura Externa 36mm Tubeless Ready Etrto Rim Size 30-622mm Erd 596mm 32 Furos Altura Do Aro 22mm Disc Brake Tamanho Do Pneu 2.25" - 2.5" Tensão Máxima Dos Raios 130kgf Resistência De Impacto 80j Peso Máximo Do Usuário 110kg Disponível Apenas Com Válvula Presta
-----------------------	---

**FATOR DE VENDA** 1

**EMBALAGEM** 10 unidades

**MATERIAL** Carbono

**PESO** 362gr - peso referente a unidade

22928





## QUEST

### ARO 29" CARBON PAREDE DUPLA 32F.

<b>CARACTERÍSTICA</b>	Aro de Carbono Quest Race Q30 SL Carbono T700+T800 Acabamento Fosco Largura Interna 30mm Largura Externa 36mm Tubeless Ready Etrto Rim Size 30-622mm Erd 596mm 32 Furos Altura Do Aro 22mm Disc Brake Tamanho Do Pneu 2.25" – 2.5" Tensão Máxima Dos Raios 130kgf Resistência De Impacto 80j Peso Máximo Do Usuário 110kg Disponível Apenas Com Válvula Presta
-----------------------	---

**FATOR DE VENDA** 1

**EMBALAGEM** 10 unidades

**MATERIAL** Carbono

**PESO** 392gr - peso referente a unidade

22926



### ARO 29" CARBON PAREDE DUPLA 28F.

<b>CARACTERÍSTICA</b>	Aro de Carbono Quest Race Q30 SL 28 Furos Carbono T700 E T800 Tubeless Ready Largura interna 30mm Largura Externa 36mm ETRTO RIM SIZE 30-622MM ERD 596MM Altura do aro 20mm Disc Brake Peso máximo do ciclista 110kg Compatível com válvula presta Medidas de pneu de 2,25" a 2,5" Tensão máxima de raio 130kgf Resistência de impacto 80J
-----------------------	--

**FATOR DE VENDA** 1

**EMBALAGEM** 10 unidades

**MATERIAL** Carbono

**PESO** 376gr

22927



## QUEST

### SUP. DE GUIDÃO ALUM. MTB AHEAD 80 MM 5° PT | LINHA QUEST

<b>MATERIAL</b>	Alumínio
<b>TAMANHO</b>	60 mm   70 mm   80 mm   90 mm e 100 mm
<b>CARACTERÍSTICA</b>	<ul style="list-style-type: none"><li>• Suporte de Guidão Alumínio</li><li>• Ângulo 5°</li><li>• Over ahead Set</li><li>• Compatível com Guidão 31.8 mm</li><li>• Acompanha tampa de acabamento do suporte de guidão e parafuso da aranha.</li></ul>
<b>PESO</b>	151g
<b>EMBALAGEM</b>	20 peças



23879 - 80 MM / 5°

23880 - 90 MM / 5°

23881 - 100 MM / 5°

# ABASTEÇA SEU ESTOQUE



**SR SUNTOUR** 

**PRODUTOS EM LIQUIDAÇÃO**

**SR SUNTOUR**



**SHOCK TRASEIRO TRIAIR2 3CR TR  
205 x 60 / 65 mm**

- Característica
- Shock Em Alumínio Ar
  - Curso 205 X 60mm
  - Controle De Rebound Com 8 Cliques
  - Sistema 3cr Com 3 Modos De Compressão
  - Sistema Interno De Pistão Flutuante
  - Sistema De Fixação Trunning
  - Compatível Com Downhill, Enduro, Freeride

Material Alumínio

Peso 480g

Embalagem 10 peças

21813

**AVISOS**

USE APENAS PARA:

- LAZER
- CROSS COUNTRY

FOTOS MERAMENTE ILUSTRATIVAS. AS INFORMAÇÕES/CONFIGURAÇÕES DE PRODUTOS PODERÃO SOFRER ALTERAÇÕES SEM AVISO PRÉVIO.

ENTRE EM CONTATO COM O SEU CONSULTOR OU FALE COM O NOSSO TIME DE TELEVENDAS PELO (33) 3277-3030.

# ABASTEÇA SEU ESTOQUE



NOMAD

### PARALAMADIANTEIRO MTB

Espec. – Compatível com bicicletas de XC, ALL MOUNTAIN, ENDURO, DOWNHILL e CROSS COUNTRY (rígidas ou full).

- Fácil instalação
- Proteção para os retentores de sua suspensão
- Elevada flexibilidade e resistência

Emb. 10pçs



VERMELHO

VERDE

AZUL

12113

# ABASTEÇA SEU ESTOQUE



 **MITSU**  
Sports



# PRODUTOS EM LIQUIDAÇÃO



## Raio Inox – MITSU

Característica Raio inox | Com niple cobre



Embalagem

255X2,5MM

00605

15 gz



## Regulador de Maçaneta – MITSU

Material	Alumínio polido
Embalagem	50 peças
GROSSO	01563

FOTOS MERAMENTE ILUSTRATIVAS. AS INFORMAÇÕES/CONFIGURAÇÕES DE PRODUTOS PODERÃO SOFRER ALTERAÇÕES SEM AVISO PRÉVIO.

ENTRE EM CONTATO COM O SEU CONSULTOR OU FALE COM O NOSSO TIME DE TELEVENDAS PELO (33) 3277-3030.





## Niple 2.0 mm x aço preto – MITSU

Material	Aço Niple aço mitsu Aço Preto
Característica	Diâmetro 2mm Comprimento 12mm
Embalagem	100 unidades
Peso	128g Peso referente a grosea (144 unidades)

13728





# PRODUTOS EM LIQUIDAÇÃO



## Manopla – MITSU

Característica Ponta cromada

Embalagem 100 peças



01169

## Corrente Corrida S50 – MITSU

Espec. – 1/2" X 3/32" 116L – 21V. – bronze

– Index

Emb. 50 pçs



02672



## Pedal Plataforma – MITSU

Material Nylon

Embalagem 50 peças

### COM ESFERA

SUÊCO 1/2



00901

INGLÊS 9/16



03294

FOTOS MERAMENTE ILUSTRATIVAS. AS INFORMAÇÕES/CONFIGURAÇÕES DE PRODUTOS PODERÃO SOFRER ALTERAÇÕES SEM AVISO PRÉVIO.

ENTRE EM CONTATO COM O SEU CONSULTOR OU FALE COM O NOSSO TIME DE TELEVENDAS PELO (33) 3277-3030.



## SHUFENG



### Caixa Cubo Dianteiro – SHUFENG

Característica Batente para cubo Shunfeng

Embalagem 2000 peças



00932

## VELOSTEEL



### Carcaça Cubo – VELOSTEEL

Característica Contra Pedal | 36 F

Embalagem 10 peças



00156



### Pinhão Fixo Encaixe – VELOSTEEL

Característica Com encaixe | Bronze

Embalagem 50 peças

16 D



00590

# IMPORTADO

## Freio V. Brake D/T – IMPORTADO

Característica Freio V Brake | Alumínio | Importado | Estrutura em alumínio | Sapatas Allen

Material Alumínio | Aço

Peso 360 gr (par)

Embalagem 25 peças



20515



# ABASTEÇA SEU ESTOQUE



**ROCKBROS**



### Óculos de Ciclismo RB-SP176

MODELO	RB-SP176
CARACTERÍSTICA	Óculos com formato anatômico e ajuste perfeito ao rosto   Design ultramoderno e proposta arrojada
MATERIAL	Armação: acetato Lentes: policarbonato
GÊNERO	Unisex
OPÇÕES DE LENTES	Cinco lentes de qualidade avançada e proteção UV400, sendo uma delas polarizada
CONJUNTO	Estojo rígido   Pano para limpeza das lentes   Saquinho para os óculos Cartão para teste de lente polarizada
ATRIBUTO ADICIONAL	Armação interna para fixação de lente de grau
PESO	ND
EMBALAGEM	1 conjunto

1  13345

2  -

3  13347





### Óculos de Ciclismo | 10163

MODELO	10163
CARACTERÍSTICA	Unisex   Lentes Polarizada   Proteção UV
LENTE	Marron (redução de brilho)
MATERIAL	Armação: TR   Lente: Policarbonato (PC)
ACESSÓRIOS	Estojo rígido   Pano para limpeza de lentes   Bolsinha para óculos   Armação interna para fixação de lente de grau
EMBALAGEM	1 conjunto

16515





### ÓCULOS DE CICLISMO | 0089

MODELO	0089
CARACTERÍSTICA	Unisex   5 lentes diferentes   Lentes Polarizadas   Proteção UV400   Perna Rígida / Headband
LENTE	Transparente   Cinza / Azul / Marrom (redução de brilho)   Amarela (noturna)
MATERIAL	Armação: Acetato   Lente: Policarbonato
ACESSÓRIOS	Estojo rígido   Pano para limpeza de lentes   Bolsinha para óculos   Cordão para óculos   Armação interna para fixação de lente de grau
EMBALAGEM	1 conjunto

16513



### Ciclo Computer | BC 18 - L21

MODELO	18 funções   Sem fio   EL Backlight
FUNÇÕES	Velocímetro   Velocidade média (AVS)   Velocidade máxima (MXS)   Tendência de velocidade   Comparação de velocidade   Seleção de Quilômetros (KM) ou Metros (M)   Odômetro (ODO)   Função de salvar Odômetro   Tripmeter (DST)   Tempo de viagem   Relógio digital   Auto Scan   Auto Power Off   Auto start/stop   Calorias   Fat Burned   Freeze Frame Memory (TM e AVS)   Graus celsius ou Fahrenheit   Temperatura
BATERIA	Duas baterias de 3v   CR2032 (1 computador/ 1 transmissor)
EMBALAGEM	20 peças

16521







## ■ Bolsa traseira | Bagageiro – 3 em 1

MODELO	A8-BK
ESPEC.	Equipamento prático, resistente e de alta durabilidade 3 bolsas independentes ligadas por zíper, a maior podendo ser usada como mochila Compartimentos internos independentes Acompanha capa à prova d'água Equipamento ideal para ciclovagens
MATERIAL	PVC   600D   Poliéster   Nylon   Malha   Tecido
COR	Preto
ATRIBUTO ADICIONAL	Logo com função refletiva, para dar mais segurança
CAPACIDADE	48 litros
PESO APROXIMADO	1,5 Kg
EMB.	1 conjunto

13349

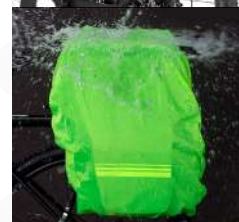

# ABASTEÇA SEU ESTOQUE



  
**NANOBODY  
TECH®**



## NANOBODY TECH®



[ NANOBODY TECH ]

### SUNSCREEN 30 FPS

**Característica** SUNSCREEN oferece proteção contra a radiação UVA/UVB e infravermelha, prevenindo os sinais do envelhecimento da pele e evitando queimaduras solares, além de promover uma sensação de hidratação sem deixar a pele oleosa.

**Embalagem** 100ml

20497



## NANOBODY TECH®



[ NANOBODY TECH ]

### GEL REFRESCANTE

**Característica** Com a mais inovadora tecnologia para cosméticos esportivos, o GEL REFRESCANTE NBT, deve ser aplicado logo após o treino para evitar a fadiga muscular e restabelecer as funções da pele, músculos e veias.

**Embalagem** 100ml

20499



[ NANOBODY TECH ]

### GEL SMOOTH SKIN

**Característica** Promove uma camada protetora com uma textura aveludada, oferecendo uma sensação única. Com toque sedoso fornece uma proteção sobre a pele, mantendo sua hidratação natural, deixando macia e aveludada. Proteção contra calos e bolhas.

**Embalagem** 100ml

20503



[ NANOBODY TECH ]

### GEL NANOGRIP

**Característica** Desenvolvido para resolver problemas de sudorese excessiva em nossas mãos. Repele o Suor e melhora 100% do seu grip em menos de 30 segundos.

**Embalagem** 100ml

20495



# ABASTEÇA SEU ESTOQUE



 **Elook**



## CADEADO ETOOK | ET 152

Modelo	ET 152
Característica	Pequeno, leve e fácil de transportar   Tranca: Código de 3 dígitos
Tamanho	1500 mm/Ø4 mm
Material	Liga de zinco
Peso	100 g
Embalagem	20 peças

17329



## CADEADO ETOOK | ET 151

Modelo	ET 151
Característica	Cabo de aço com tratamento térmico especial, dificulta que seja arrebitado e cortado   Suporte Easy Clip para canote de bicicleta Ø25.4 a 30.8 mm   2 Chaves
Tamanho	1500 mm/Ø12 mm
Peso	533 g
Embalagem	20 peças

17330



## CADEADO ETOOK | ET 150

Modelo	ET 150
Característica	Cabo de aço com tratamento térmico especial, dificulta que seja arrebitado e cortado   Suporte Easy Clip para canote de bicicleta Ø25.4 a 30.8 mm   Tranca: Código de 4 dígitos
Tamanho	1500 mm/Ø12 mm
Peso	536 g
Embalagem	20 peças

17331



## CADEADO ETOOK | ET 461

Modelo	ET 461
Característica	Cabo de aço (15 mm de espessura) com tratamento térmico especial, dificulta que seja arrebitado e cortado   Suporte Easy Clip para canote de bicicleta Ø25.4 a 30.8 mm   Tranca: Código de 4 dígitos
Tamanho	1500 mm/Ø15 mm
Peso	570 g
Embalagem	20 peças

17332



## CADEADO ETOOK | ET 355

Modelo	ET 355
Característica	Pequeno e compacto   Leve e Prático   Corrente de elo quadrado (4 mm)   Tranca: Código de 4 dígitos   Aço rígido com tratamento especial, dificulta que seja estourado, serrado, cortado e perfurado   Capa de tecido impermeável para proteção
Tamanho	900 mm/Ø4 mm
Peso	312 g
Embalagem	20 peças

17326



## CADEADO ETOOK | ET 355-S

Modelo	ET 355s
Característica	Pequeno e leve   Fácil transporte   Corrente de elo quadrado (4 mm)   Tranca: Código de 4 dígitos   Aço rígido com tratamento especial, dificulta que seja estourado, serrado, cortado e perfurado   Capa de tecido impermeável para proteção
Tamanho	450 mm/Ø4 mm
Peso	160 g
Embalagem	20 peças

17327



# PRODUTOS EM LIQUIDAÇÃO



## CADEADO ETOOK | ET 465

Modelo	ET 465
Característica	Cilindro da fechadura em liga de Zinco com 8mm de espessura   Tranca: Código de 4 dígitos   Aço rígido com tratamento especial, dificulta que seja estourado, serrado, cortado e perfurado   Capa de tecido impermeável para proteção
Tamanho	1000 mm/Ø6 mm
Peso	900 g
Embalagem	20 peças

17328



## CADEADO ETOOK | ET 455

Modelo	ET 455
Característica	Tecnologia avançada de cilindro de fechadura com a chave de apenas 0,3-0,6 mm de espessura   Aço rígido com tratamento especial, dificulta que seja estourado, serrado, cortado e perfurado   Capa de tecido impermeável para proteção
Tamanho	1000 mm/Ø6 mm
Peso	900 g
Embalagem	20 peças

17324



## CADEADO ETOOK | ET 555

Modelo	ET 555
Característica	Corrente quadrada de 8 mm com capa de tecido impermeável para proteção   Mecanismo de travamento automático   Corpo do cilindro da fechadura com design fechado de alta proteção contra roubo   Tecnologia avançada de cilindro de fechadura com a chave de apenas 0,3-0,6 mm de espessura   Tampa anti-perfuração   Aço especial com tratamento térmico, sua robustez e alta tenacidade dificulta que seja cortado pelo cortador hidráulico 15T, batido, serrado e perfurado   Resistência à capacidade de tração de 1 tonelada
Tamanho	1100 mm/Ø8 mm
Peso	1.63 kg
Embalagem	20 peças

17323



## CADEADO ETOOK | ET 155L

Modelo	ET 155L
Característica	Tecnologia avançada de cilindro de fechadura com a chave de apenas 0,3-0,6 mm de espessura   Aço rígido com tratamento especial, dificulta que seja estourado, serrado, cortado e perfurado   Capa de tecido impermeável para proteção
Tamanho	1100 mm/Ø7 mm
Peso	1.03 kg
Embalagem	20 peças

17325

FOTOS MERAMENTE ILUSTRATIVAS. AS INFORMAÇÕES/CONFIGURAÇÕES DE PRODUTOS PODERÃO SOFRER ALTERAÇÕES SEM AVISO PRÉVIO.

ENTRE EM CONTATO COM O SEU CONSULTOR OU FALE COM O NOSSO TIME DE TELEVENDAS PELO (33) 3277-3030.

# ABASTEÇA SEU ESTOQUE



**LOCK Kinguard**



## LOCK Kinguard



### Cadeado Gomo 1000 mm | Mod. 01

Característica	Tranca por chave   2 chaves   Tipo gomo
Tamanho	25 x 1000 mm
Peso	808 g
Embalagem	15 peças
	17310



### Cadeado Gomo 1500 mm | Mod. 01

Característica	Tranca por chave   2 chaves   Tipo gomo
Tamanho	25 x 1500 mm
Peso	1.04 kg
Embalagem	15 peças
	17311



### Cadeado com Corrente 10 x 1200 mm | Mod. 01

Característica	Tranca por chave   2 chaves   Tipo corrente de elos
Tamanho	10 x 10 x 1200 mm
Peso	2.45 kg
Embalagem	15 peças
	17317



### Cadeado Gomo 1000 mm | Mod. 02

Característica	Tranca por chave   2 chaves   Tipo gomo   Com tampa
Tamanho	25 x 1000 mm
Peso	741g
Embalagem	15 peças
	17312



### Cadeado Gomo 1500 mm | Mod. 02

Característica	Tranca por chave   2 chaves   Tipo gomo   Com tampa
Tamanho	25 x 1500 mm
Peso	983 g
Embalagem	15 peças
	17313



### Cadeado com Corrente 10 x 1200 mm | Mod. 02

Característica	Tranca por chave   2 chaves   Tipo corrente de elos   Com tampa
Tamanho	10 x 10 x 1200 mm
Peso	2.40 kg
Embalagem	15 peças
	17318

## LOCK Kinguard



### /// Cadeado Aço Espiral 8 x 1800 mm

Característica	Tranca por chave   2 chaves   Tipo aço espiral   Suporte Easy Clip com fechamento tipo braçadeira
Tamanho	8 x 1800 mm
Material	Aço
Peso	383 g
Embalagem	20 peças

17314



### /// Cadeado Aço Espiral 10 x 800 mm

Característica	Tranca por chave   2 chaves   Tipo aço espiral   Suporte Easy Clip com fechamento tipo braçadeira
Tamanho	10 x 800 mm
Material	Aço
Peso	231 g
Embalagem	20 peças

17316



### /// Cadeado Aço Espiral 12 x 1800 mm

Característica	Tranca por chave   2 chaves   Tipo aço espiral   Suporte Easy Clip com fechamento tipo braçadeira
Tamanho	12 x 1800 mm
Material	Aço
Peso	536 g
Embalagem	20 peças

17315

# ABASTEÇA SEU ESTOQUE



**SUPPLY  
WIPES**

## SUPPLY WIPES



### Toalhas Umedecidas Bike Wipes | Pote

<b>CARACTERÍSTICA</b>	Praticidade e agilidade na remoção de sujeiras grosseiras como barro, graxa e óleo  Pode ser usado tanto na bicicleta quanto para limpar as sujidades na pele do ciclista
<b>TAMANHO E QUANTIDADE</b>	50 unidades   20x18 cm
<b>INFLAMABILIDADE</b>	Não Inflamável
<b>OBSERVAÇÃO</b>	Fácil de utilizar   Não agride a pele   Usar um lenço por vez   Após o uso manter fechado
<b>PESO</b>	245 g
<b>EMBALAGEM</b>	12 peças
	14882

# SUPPLY WIPES



## Toalhas Umedecidas Desengraxante | Pote

<b>CARACTERÍSTICA</b>	Limpa as sujeiras mais pesadas sem a necessidade de água
	Grande eficiência na remoção de graxa, óleo, tinta, graxa etc.
<b>TAMANHO E QUANTIDADE</b>	35 unidades   20x18 cm
<b>INFLAMABILIDADE</b>	Não Inflamável
<b>OBSERVAÇÃO</b>	Fácil de utilizar   Não agride a pele   Usar um lenço por vez   Após o uso descartar o lenço no lixo
<b>PESO</b>	315 g
<b>EMBALAGEM</b>	12 peças
	14883



## Toalhas Umedecidas Álcool 73% | Pote

<b>CARACTERÍSTICA</b>	Produto destinado a limpeza e higienização em geral
<b>TAMANHO E QUANTIDADE</b>	35 unidades   20x18 cm
<b>INFLAMABILIDADE</b>	Inflamável
<b>OBSERVAÇÃO</b>	Fácil de utilizar   Não agride a pele   Usar um lenço por vez   Após o uso manter fechado.
<b>EMBALAGEM</b>	12 peças
	14884

# ABASTEÇA SEU ESTOQUE



**PROMEND**



# PRODUTOS EM LIQUIDAÇÃO



## PROMEND



### MOCHILA DE HIDRATAÇÃO MODELO 01

<b>CARACTERÍSTICA</b>	Faixa refletiva em 8 pontos   Alça elástica externa   Refil interno
<b>REFIL</b>	2 litros   Tubo de 106 cm   Tampa com fechamento em rosca
<b>MATERIAL</b>	Interno: Fibrã + EVA   Externo: Nylon e poliéster
<b>TAMANHO</b>	430 x 280 x 80 mm
<b>PESO</b>	300g
<b>EMBALAGEM</b>	5 peças

■ 13868

■ 13869

■ 13870

■ 13871



FOTOS MERAMENTE ILUSTRATIVAS. AS INFORMAÇÕES/CONFIGURAÇÕES DE PRODUTOS PODERÃO SOFRER ALTERAÇÕES SEM AVISO PRÉVIO.

ENTRE EM CONTATO COM O SEU CONSULTOR OU FALE COM O NOSSO TIME DE TELEVENDAS PELO (33) 3277-3030.



# PRODUTOS EM LIQUIDAÇÃO



## PROMEND



### MOCHILA DE HIDRATAÇÃO MODELO 02

**CARACTERÍSTICA** Faixa refletiva em 8 pontos | Alça elástica externa | Refil interno

**REFÍL** 2 litros | Tubo de 106 cm | Tampa com fechamento em rosca

**MATERIAL** Interno: Fibra + EVA | Externo: Nylon e poliéster

**TAMANHO** 455 x 225 x 50 mm

**PESO** 330g

**EMBALAGEM** 5 peças

13872

13873

13874

13875

13876



FOTOS MERAMENTE ILUSTRATIVAS. AS INFORMAÇÕES/CONFIGURAÇÕES DE PRODUTOS PODERÃO SOFRER ALTERAÇÕES SEM AVISO PRÉVIO.

ENTRE EM CONTATO COM O SEU CONSULTOR OU FALE COM O NOSSO TIME DE TELEVENDAS PELO (33) 3277-3030.





## PROMEND



### BOLSA DE CELULAR MODELO 02

<b>MODELO</b>	14E36
<b>CARACTERÍSTICA</b>	Fechamento em velcro
<b>MATERIAL</b>	Poliuretano / Poliuretano Termoplástico
<b>TAMANHO</b>	162 * 94mm
<b>EMBALAGEM</b>	10 peças

11785

# ABASTEÇA SEU ESTOQUE



**CHAOYANG**®

*Passion For Forward*



**CHAORYANG**<sup>®</sup>  
Passion For Forward



**20"**  
WHEELS

## Câmara 20 x 1.95 | Válvula americana

**CARACTERÍSTICA** Câmara aro 20" x 1.95/2.125 (50/54-406) Arisun | Válvula americana | Material resistente e design uniforme | Proporciona segurança e boa performance.

**MATERIAL** Borracha

**PESO** 148 gr

**EMBALAGEM** 20 peças

20519

# ABASTEÇA SEU ESTOQUE



**TRUE**<sup>®</sup>  
**SPORT**

FOTOS MERAMENTE ILUSTRATIVAS. AS INFORMAÇÕES/CONFIGURAÇÕES DE PRODUTOS PODERÃO SOFRER ALTERAÇÕES SEM AVISO PRÉVIO.

ENTRE EM CONTATO COM O SEU CONSULTOR OU FALE COM O NOSSO TIME DE TELEVENDAS PELO (33) 3277-3030.

## TRUE<sup>®</sup> SPORT



### TIRAS SUPORTE (LEVE BIKE) UNITÁRIO TRUE

Modelo	Tiras 34
Característica	Tira suporte (leve bike)
Fator	4
Embalagem	50 peças
	19050

# ABASTEÇA SEU ESTOQUE





## VACINA DE PNEU | BIKE

### CARACTERÍSTICA

Com a bicicleta em movimento, o furo é vedado instantaneamente. Caso o pneu perca a pressão, basta reinflar com o furo para baixo para que haja contato com o selante e, em seguida, rodar com a bicicleta. A dosagem é única e pode ser aplicado em todos os tipos de bicicleta exceto os modelos equipados com pneus SPEED.

### ESPECIFICAÇÃO

- Diâmetro máximo do objeto perfurante liso de até 2mm;
- Pneus com ou sem câmara de ar;
- Produto preventivo: aplicar antes do pneu furar;
- Ecologicamente correto: biodegradável, atóxico e não inflamável;
- Saca-válvula de metal incluso no kit;
- Aplicar usando uma pistola de silicone (não inclusa no kit);
- Pode ser aplicado em pneus com válvula SCHRADER e PRESTA com núcleo de válvula removível.

### APLICAÇÃO

1. Agite o frasco por 20 segundos antes de aplicar o produto;
2. Remova o núcleo de válvula usando o saca-válvula de metal;
3. Aguarde o esvaziamento completo do pneu;
4. Corte a ponta do frasco com um estilete;
5. Rosqueie firmemente a mangueira aplicadora o frasco;
6. Injete lentamente todo conteúdo do frasco usando uma pistola aplicadora de silicone;
7. Aplique um jato de ar na válvula para eliminar resíduos do selante;
8. Reinstale o núcleo de válvula;
9. Calibre o pneu seguindo a recomendação do fabricante da bicicleta;
10. Recoloque a tampa para proteger a válvula de sujeira.

### ATENÇÃO

- Veda furos somente na banda de rodagem;
- Funciona com pressão mínima de 20 PSI;
- Não veda ragos nem cortes;
- Não aplicar em pneus SPEED;
- Evitar aplicar em pneus ou câmaras de ar com remendo a frio.
- Para aplicar em pneus com válvula PRESTA, remover o bico com rosca e conectar diretamente a mangueira na válvula.

### EMBALAGEM

24 peças

16294



**TSW**

B I K E



CATÁLOGO

**B I C I C L E T A S**

Versão 07 de Março 2024





SELUXE  
SELECT +

CANOTE	Ø 1
FREIO DISCO	180
EIXO TRASEIRO	140
MATERIAL	ALUMINIO
LARGURA MÁXIMA PNEU	29,5
CURSO MÁXIMO DO QUADRO	150
MEDIDA SUSPENSÃO TRASEIRA	200
CURSO MÁXIMO SUSPENSÃO TRASEIRA	65
GUIA DE CORRENTE	150
PESO MÁXIMO	ATE 100

29 X 2.40

# ALL QUEST



SHIMANO



BICICLETAS



Montanha

Carbono

Boost



RockShox BOOST



1x12 Shimano



Deore XT



16.68 Kg



QUADRO

29" | TSW ALL Quest | Full Suspension Carbon Toray (acabamento UD) | Monocoque | Link e triângulo traseiro carbono | Direção Tapered | Disc brake post mount | Chain guide ISCG-05 | Central BSA | Boost 148x12 mm THRU AXLE | Curso traseiro 150 mm



SUSPENSÃO DIANTEIRA

RockShox 35 SILVER TK 150 mm/160 mm | Solo Air | 15x110 mm | 29" | 51 mm offset | Coil | Dual Position Coil | Haste 35 mm



SUSPENSÃO TRASEIRA

Rock Shox Deluxe Select + | 205 x 65mm | Rebound Tune M | Compression tune L1 | 2-position compression



MOVIMENTO DE DIREÇÃO

Tapered | Semi-integrada (ZS) | Rolamentado



GUIDÃO

Quest | Alumínio | 35 x 800 mm | Upsweep 5° | Backsweep 7° | Rise 15 mm



SUPOORTE DE GUIDÃO

Quest | 35 x 45 mm/0° | Alumínio



MANOPLA

TSW Light | Preto



CONJUNTO DE FREIO

**Dianteiro:** Shimano SLX M7100 ou XT MT8120 pinça com 4 pistões /**Traseiro:** Shimano SLX M7100 pinça com 4 pistões ou XT MT8100 pinça com 2 pistões, Disco, Hidráulico



DISCO DE FREIO

**Dianteiro:** 203 mm **Traseiro:** 180 mm | Center lock, Shimano SM-RT64 ou RT-MT800 Ice Tech



ARO/RAIO

**Aro:** WTB Kom Trail i 35 | 35 mm interno | **Tubeless ready** | 32 Furos **Raio:** Inox com niple



CUBOS BOOST

**Traseiro:** Shimano Boost MT-410 | 148x12 mm | 32 furos | 12 Velocidades **Dianteiro:** Shimano Boost MT-400B | 15x110 mm | 32 furos



PNEU / CÂMARA DE AR

**Pneu:** 29 x 2.4" | Válvula presta 48 mm | Vittoria (Modelo disponível no estoque 2.4) **Câmara de Ar:** Arisun



PEDIVELA

Shimano MT-510 | Single | Braço 170 mm | Coroa 34 dentes



CORRENTE

Shimano Deore | 12 velocidades



EIXO CENTRAL

Shimano MT500



CASSETE

Shimano Deore M6100 | 10-51 | 12 velocidades



CÂMBIO DIANTEIRO

N/A



CÂMBIO TRASEIRO

Deore XT | 12 velocidades



ALAVANCA

Traseira | Shimano SLX | 12 velocidades



SELIM

MTB | Promend | Trilho de Cromoly



CANOTE

Quest | Retrátil | 31.6 x 385 mm | 100 mm curso | Acionamento (Mecânico) Remoto



ABRAÇADEIRA

Quest | 34.9 mm | Alumínio | Parafuso



PEDAL

N/A

15.5" NAC. 22284 - F160MM

FOTOS MERAMENTE ILUSTRATIVAS. AS INFORMAÇÕES/CONFIGURAÇÕES DE PRODUTOS PODERÃO SOFRER ALTERAÇÕES SEM AVISO PRÉVIO.

ENTRE EM CONTATO COM O SEU CONSULTOR OU FALE COM O NOSSO TIME DE TELEVENDAS PELO (33) 3277-3030.

TSW

4

# ALL QUEST SHIMANO DEORE



29" WHEELS

Montanha

Carbono

Boost

RockShox BOOST

1x12 Shimano

Deore

Kg 16.68



QUADRO

29" TSW ALL Quest, Full Suspension Carbon Toray (acabamento UD), Monocoque e triângulo traseiro carbono, Direção Tapered, Disc brake post mount, Chain guide ISCG-05, Central BSA, Boost 148x12mm THRU AXLE, Curso traseiro 150mm



SUSPENSÃO DIANTEIRA

RockShox 35 SILVER TK 150 mm/160 mm | Solo Air | 15x110 mm | 29" | 51 mm offset | Coil | Dual Position Coil | Haste 35 mm



SUSPENSÃO TRASEIRA

Rock Shox Deluxe Select + | 205 x 65mm | Rebound Tune M | Compression tune L1 | 2-position compression



MOVIMENTO DE DIREÇÃO

Tapered | Semi-integrada (ZS) | Rolamentado



GUIDÃO

Quest | Alumínio | 35 x 800 mm | Upsweep 5° | Backsweep 7° | Rise 15 mm



SUPOORTE DE GUIDÃO

Quest | 35 x 45 mm/0° | Alumínio



MANOPLA

TSW Light | Preto



CONJUNTO DE FREIO

**Dianteiro:** Shimano SLX M7100 pinça com 4 pistões **Traseiro:** Shimano SLX M7100 pinça com 4 pistões, Disco, Hidráulico



DISCO DE FREIO

**Dianteiro:** Center Lock, 203 mm / **Traseiro** 180 mm, Shimano SM-RT64



ARO/RAIO

**Aro:** WTB Kom Trail i 35 | 35 mm interno | **Tubeless ready** | 32 Furos **Raio:** Inox com niple



CUBOS BOOST

12 Velocidades / **Dianteiro:** Boost, Shimano MT400B, Eixo de 15 mm, OLD 110 mm, 32 furos / **Traseiro:** Boost, Shimano MT 410, OLD 148 mm, Eixo de 12 mm, 32 furos, Free Hub Micro-Spline



PNEU / CÂMARA DE AR

**Pneu:** 29 x 2.4" | Válvula presta 48 mm | Vittoria (Modelo disponível no estoque 2.4) **Câmara de Ar:** Arisun



PEDIVELA

Shimano MT-510 | Single | Braço 170 mm | Coroa 34 dentes



CORRENTE

Shimano Deore | 12 velocidades



EIXO CENTRAL

Shimano MT500



CASSETE

10-51, 12 Velocidade, Shimano Deore M6100



CÂMBIO DIANTEIRO

N/A



CÂMBIO TRASEIRO

12 velocidades, Deore M6100



ALAVANCA

12 Velocidades, Shimano Deore M6100, Traseira



SELIM

MTB | Promend | Trilho de Cromoly



CANOTE

Quest | Retrátil | 31.6 x 385 mm | 100 mm curso | Acionamento (Mecânico) Remoto



ABRAÇADEIRA

Quest | 34.9 mm | Alumínio | Parafuso

15.5" NAC. 21558 - F160MM

17.5" NAC. 21559 - F160MM

19" NAC. 21560 - F160MM



# FULL QUEST Advanced+



SHIMANO



29" WHEELS

 Montanha

 Carbono

 Boost

 Rock Shox BOOST

 1x12 Shimano

 Shimano

 Kg 11.95

 **QUADRO** 29" | TSW Full Quest | Full Suspension | Carbono | Monocoque | Link e Triângulo traseiro carbono | Direção Tapered | Disc brake post mount | Boost 148x12mm THRU AXLE | Curso traseiro 110mm | Press-Fit

 **SUSPENSÃO DIANTEIRA** Rock Shox Sid Select + | 120 mm | Tapered | Eixo de 15 mm | Trava Remota

 **SUSPENSÃO TRASEIRA** RockShox SIDLuxe Select + | 165 x 40 mm | Trava Remota

 **MOVIMENTO DE DIREÇÃO** Tapered Integrado

 **GUIDÃO** Quest | Carbono | 800 mm | Backsweep 6° | Upsweep 3°

 **SUPORE DE GUIDÃO** Carbono | Integrado com o guidão | 2° | 70 mm

 **MANOPLA** TSW Light | Preto

 **CONJUNTO DE FREIO** Disco | Hidráulico | Shimano XT MT8100

 **DISCO DE FREIO** Shimano RT-MT900 | Center lock | 180 mm | Ice Tech

 **ARO/RAIO** WTB ST I30 light ou I35 | Alumínio | 28 furos | Parede dupla | **Tubeless Ready** | Largura interna 30 mm | Raio Inox com Niple

 **CUBOS BOOST** **Traseiro:** Shimano XTR M9111-B | 148 x 12 mm | 28 furos | 12 Velocidades / **Dianteiro:** Shimano M9110-B | 15 mm | 28 furos

 **PNEU / CÂMARA DE AR** **Pneu:** Vittoria ( **Modelo disponível no estoque** ) | 29" / **Câmara de Ar:** Arisun | Válvula Presta 48 mm

 **PEDIVELA** Shimano XT FC-M8100-1 | Single | Braço 170 mm | Coroa 34 Dentes

 **CORRENTE** Shimano XT M8100 | 12 Velocidades

 **EIXO CENTRAL** Shimano MT500 | Press-Fit

 **CASSETE** Shimano XTR M9100 | 10-51T | 12 Velocidades

 **CÂMBIO DIANTEIRO** N/A

 **CÂMBIO TRASEIRO** Shimano XTR M9100 | 12 Velocidades

 **ALAVANCA** Shimano XT SL-M8100 | 12 Velocidades | Traseiro

 **SELIM** Promend | MTB | Trilho de Cromoly

 **CANOTE** Quest | Carbono | 31.6 x 400 mm

 **ABRAÇADEIRA** Alumínio | 34.9 mm | Parafuso

 **PEDAL** N/A

17.5" NAC. 16856

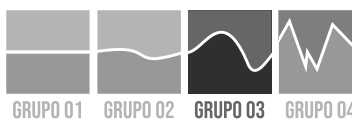

**XC (CROSS COUNTRY)/ TRAIL**

Bicicletas do Grupo 03 são feitas para girar em trilhas pavimentadas ou não com maior frequência de raízes, pedras, areia e pequenas depressões, mantendo constante contato das rodas com o solo podendo perder este contato por um curto tempo. Sem saltos, sem andar em uma roda (dianteira ou traseira), sem frenagem que faça com que a roda traseira levante.

FOTOS MERAMENTE ILUSTRATIVAS. AS INFORMAÇÕES/CONFIGURAÇÕES DE PRODUTOS PODERÃO SOFRER ALTERAÇÕES SEM AVISO PRÉVIO.

ENTRE EM CONTATO COM O SEU CONSULTOR OU FALE COM O NOSSO TIME DE TELEVENDAS PELO (33) 3277-3030.

# FULL QUEST STARTER-SX



SRAM



29" WHEELS

Montanha

Carbono

Boost



RockShox BOOST

1x12 Sram

Shimano

13.9 kg



QUADRO

29" | TSW Full Quest | Full Suspension | Carbono | Monocoque | Link e Triângulo traseiro carbono | Direção Tapered | Disc brake post mount | Boost 148x12mm THRU AXLE | Curso traseiro 110mm | Press-Fit



SUSPENSÃO DIANTEIRA

29" | RockShox Recon Silver RL | 120 mm | Solo Air | Tapered | 15 x 110 mm | Offset 51 mm



SUSPENSÃO TRASEIRA

RockShox Deluxe Select + | 165x 40mm | 2-position compression



MOVIMENTO DE DIREÇÃO

Tapered Integrado



GUIDÃO

Quest | Reto | Alumínio | 31.8 x 740 mm | 0 Rise | 0 upsweep | 9° Backsweep



SUPORTE DE GUIDÃO

Quest | Alumínio | 70 mm/17°



MANOPLA

TSW Light | Preto



CONJUNTO DE FREIO

Shimano Hidráulico MT 200 | Disco



DISCO DE FREIO

Shimano | 160 mm | Center lock | RT-54



ARO/RAIO

WTB ST I30 ou I35 | 32 furos | Tubeless Ready | Freio a disco | Parede dupla | 30 mm largura interna / Raio Inox com Niple



CUBOS BOOST

**Dianteiro:** Shimano Boost MT400B | O.L.D. 110 | Eixo de 15 mm | 32 furos / **Traseiro:** Boost MT400B | O.L.D. 148 mm | Eixo de 12 mm | 32 Furos



PNEU / CÂMARA DE AR

**Pneu:** Vittoria ( Modelo disponível no estoque) | 29" / **Câmara de Ar:** Arisun | Válvula Presta 48 mm



PEDIVELA

Sram X1 | Single | 11/12 velocidades | DUB | Coroa 32 dentes



CORRENTE

Sram SX 12 velocidades

EIXO CENTRAL

Sram DUB | Press Fit



CASSETE

Sram SX | 12 velocidades | 11-50T



CÂMBIO DIANTEIRO

N/A



CÂMBIO TRASEIRO

Sram SX | 12 Velocidades



ALAVANCA

Sram SX | 12 Velocidades



SELIM

TSW MTB | Preto | Vazado



CANOTE

Quest | Alumínio | 31.6 x 400 mm | Slim | Micro Ajuste



ABRAÇADEIRA

Quest | Alumínio | 34.9 mm | Parafuso



PEDAL

N/A

15.5" NAC. 22292

19" NAC. 22294



GRUPO 01 GRUPO 02 GRUPO 03 GRUPO 04

XC (CROSS COUNTRY)/ TRAIL

Bicicletas do Grupo 03 são feitas para girar em trilhas pavimentadas ou não com maior frequência de raízes, pedras, areia e pequenas depressões, mantendo constante contato das rodas com o solo podendo perder este contato por um curto tempo. Sem saltos, sem andar em uma roda (dianteira ou traseira), sem frenagem que faça com que a roda traseira levante.



EVOLVING QUEST





# YUKON

## GX-SM



	<b>QUADRO</b>	TSW YUKON 29"   Alumínio 6061   Cabeamento interno   Direção Tapered $\varnothing$ 44 x 55 mm   Freio a disco post mount   Caixa central BSA 73 mm   Eixo traseiro Boost 12 x 148mm   Canote 31.6 mm   Largura máxima do pneu 29 x 2.4"   Peso máximo suportado de 120 kg
	<b>SUSPENSÃO DIANTEIRA</b>	Rock Shox Judy TK 120 mm   Óleo/Ar   Eixo 15 mm   Trava remota
	<b>SUSPENSÃO TRASEIRA</b>	N/A
	<b>MOVIMENTO DE DIREÇÃO</b>	Tapered   Semi-integrada (ZS)   Esfera
	<b>GUIDÃO</b>	X-Time   Alumínio   Reto   31.8 x 740 mm   9° Backsweep
	<b>SUPOORTE DE GUIDÃO</b>	X-Time   Alumínio   Ahead   70 mm   17°
	<b>MANOPLA</b>	TSW Light
	<b>CONJUNTO DE FREIO</b>	Shimano Hidráulico MT 200   Disco
	<b>DISCO DE FREIO</b>	Shimano RT 26 ou RT 56   160 mm   Parafuso
	<b>ARO/RAIO</b>	WTB SI 30   Alumínio   32 furos   Parede dupla   <b>Tubeless Ready</b>   Largura interna 30 mm   Raio Preto 2 mm com Niple
	<b>CUBOS</b>	<b>Dianteiro:</b> Boost   Eixo de 15 mm   OLD 110 mm   32 furos / <b>Traseiro:</b> Boost   OLD 148 mm   Eixo de 12 mm   32 furos   XD System
	<b>PNEU / CÂMARA DE AR</b>	<b>Pneu:</b> Vittoria ( <b>Modelo disponível no estoque</b> )   29" / <b>Câmara de Ar:</b> Arisun   Válvula Presta 48 mm
	<b>PEDIVELA</b>	Sram X1   Single   11/12 velocidades   DUB   Coroa 32 dentes
	<b>CORRENTE</b>	Sram SX 12 velocidades
	<b>EIXO CENTRAL</b>	Sram DUB   BSA

	<b>CASSETE</b>	Sram GX EAGLE   12 velocidades   10-52T
	<b>CÂMBIO DIANTEIRO</b>	N/A
	<b>CÂMBIO TRASEIRO</b>	Sram GX EAGLE   12 Velocidades   Cage com trava
	<b>ALAVANCA</b>	Sram GX EAGLE   12 Velocidades
	<b>SELIM</b>	TSW MTB   Preto   Vazado
	<b>CANOTE</b>	X-Time   Alumínio   31.6 x 350 mm   Slim   Dois Parafusos   Micro Ajuste
	<b>ABRAÇADEIRA</b>	X-Time   34.9 mm   Blocagem
	<b>PEDAL</b>	Plataforma   MTB   Alumínio   Preto
	<b>URBANA</b>	✓
	<b>CICLOTURISMO</b>	✓
	<b>TRILHAS INTERMEDIÁRIAS</b>	✓
	<b>COMPETIÇÃO</b>	✓
	<b>PESO APROXIMADO</b>	13.48 kg (17")

29" NACIONAL

15.5 ■ 22156













17 ■ N/A

# YUKON

## SM-12



	<b>QUADRO</b>	TSW YUKON 29"   Alumínio 6061   Cabeamento interno   Direção Tapered Ø 44 x 55 mm   Freio a disco post mount   Caixa central BSA 73 mm   Eixo traseiro Boost 12 x 148mm   Canote 31.6 mm   Largura máxima do pneu 29 x 2.4"   Peso máximo suportado de 120 kg
	<b>SUSPENSÃO DIANTEIRA</b>	Rock Shox Judy TK 120 mm   Óleo/Ar   Eixo 15 mm   Trava remota
	<b>SUSPENSÃO TRASEIRA</b>	N/A
	<b>MOVIMENTO DE DIREÇÃO</b>	Tapered   Semi-integrada (ZS)   Esfera
	<b>GUIDÃO</b>	X-Time   Alumínio   Reto   31.8 x 740 mm   9° Backsweep
	<b>SUPORE DE GUIDÃO</b>	X-Time   Alumínio   Ahead   70 mm   17°
	<b>MANOPLA</b>	TSW Light
	<b>CONJUNTO DE FREIO</b>	Shimano Hidráulico MT 200   Disco
	<b>DISCO DE FREIO</b>	Shimano RT 30   160 mm   Center lock
	<b>ARO/RAIO</b>	<b>Aro:</b> TSW T10.000 <b>Tubeless Ready</b>   Parede Dupla   29" 622 x 26mm   Altura do perfil: 19,5 mm   ERD 602mm   32 furos   Alumínio 6061   Válvula Presta (Fina)   Pneu: 1.9" até 2.6" / <b>Raio:</b> Preto   2 mm   Niple preto
	<b>CUBOS</b>	<b>Dianteiro:</b> Boost   Shimano MT400B   Eixo de 15 mm   OLD 110 mm   32 furos / <b>Traseiro:</b> Boost   Shimano M7010 / MT400B   OLD 148 mm   Eixo de 12 mm   32 furos
	<b>PNEU / CÂMARA DE AR</b>	Pneu Arisun Bona/Graham   Skinwall   29" / Câmara de ar Arisun   Válvula presta(Fina) 48 mm
	<b>PEDIVELA</b>	Sram X1   Single   11/12 velocidades   DUB   Coroa 32 dentes

	<b>CORRENTE</b>	Sram SX 12 velocidades
	<b>EIXO CENTRAL</b>	Sram DUB   BSA
	<b>CASSETE</b>	Sram SX   12 velocidades   11-50T
	<b>CÂMBIO DIANTEIRO</b>	N/A
	<b>CÂMBIO TRASEIRO</b>	Sram SX   12 Velocidades
	<b>ALAVANCA</b>	Sram SX   12 Velocidades
	<b>SELIM</b>	TSW MTB   Preto   Vazado
	<b>CANOTE</b>	X-Time   Alumínio   31.6 x 350 mm   Slim   Dois Parafusos   Micro Ajuste
	<b>ABRAÇADEIRA</b>	X-Time   34.9 mm   Blocação
	<b>PEDAL</b>	Plataforma   MTB   Alumínio   Preto
	<b>URBANA</b>	✓
	<b>CICLOTURISMO</b>	✓
	<b>TRILHAS INTERMEDIÁRIAS</b>	✓
	<b>COMPETIÇÃO</b>	✓
	<b>PESO APROXIMADO</b>	13.92 kg (17")

### 29" NACIONAL

15.5  22139

21  N/A

# YUKON

## SM-12



	<b>QUADRO</b>	TSW YUKON 29"   Alumínio 6061   Cabeamento interno   Direção Tapered ø 44 x 55 mm   Freio a disco post mount   Caixa central BSA 73 mm   Eixo traseiro Boost 12 x 148mm   Canote 31.6 mm   Largura máxima do pneu 29 x 2.4"   Peso máximo suportado de 120 kg
	<b>SUSPENSÃO DIANTEIRA</b>	Rock Shox Judy TK 120 mm   Óleo/Ar   Eixo 15 mm   Trava remota
	<b>SUSPENSÃO TRASEIRA</b>	N/A
	<b>MOVIMENTO DE DIREÇÃO</b>	Tapered   Semi-integrada (ZS)   Esfera
	<b>GUIDÃO</b>	X-Time   Alumínio   Reto   31.8 x 740 mm   9° Backsweep
	<b>SUPORE DE GUIDÃO</b>	X-Time   Alumínio   Ahead   70 mm   17°
	<b>MANOPLA</b>	TSW Light
	<b>CONJUNTO DE FREIO</b>	Shimano Hidráulico MT 200   Disco
	<b>DISCO DE FREIO</b>	Shimano RT 30   160 mm   Center lock
	<b>ARO/RAIO</b>	Aro: TSW T10.000 Tubeless Ready   Parede Dupla   29" 622 x 26mm   Altura do perfil: 19,5 mm   ERD 602mm   32 furos   Alumínio 6061   Válvula Presta (Fina)   Pneus: 1.9" até 2.6" / Raio: Preto   2 mm   Niple preto
	<b>CUBOS</b>	<b>Dianteiro:</b> Boost   Shimano MT400B   Eixo de 15 mm   OLD 110 mm   32 furos / <b>Traseiro:</b> Boost   Shimano M7010 / MT400B   OLD 148 mm   Eixo de 12 mm   32 furos
	<b>PNEU / CÂMARA DE AR</b>	Pneu Arisun Bona/Graham   Skinwall   29" / Câmara de ar Arisun   Válvula presta(Fina) 48 mm
	<b>PEDIVELA</b>	Sram X1   Single   11/12 velocidades   DUB   Coroa 32 dentes

	<b>CORRENTE</b>	Sram SX 12 velocidades
	<b>EIXO CENTRAL</b>	Sram DUB   BSA
	<b>CASSETE</b>	Sram SX   12 velocidades   11-50T
	<b>CÂMBIO DIANTEIRO</b>	N/A
	<b>CÂMBIO TRASEIRO</b>	Sram SX   12 Velocidades
	<b>ALAVANCA</b>	Sram SX   12 Velocidades
	<b>SELIM</b>	TSW MTB   Preto   Vazado
	<b>CANOTE</b>	X-Time   Alumínio   31.6 x 350 mm   Slim   Dois Parafusos   Micro Ajuste
	<b>ABRAÇADEIRA</b>	X-Time   34.9 mm   Blocação
	<b>PEDAL</b>	Plataforma   MTB   Alumínio   Preto
	<b>URBANA</b>	✓
	<b>CICLOTURISMO</b>	✓
	<b>TRILHAS INTERMEDIÁRIAS</b>	✓
	<b>COMPETIÇÃO</b>	✓
	<b>PESO APROXIMADO</b>	13.92 kg (17")

### 29" NACIONAL

15.5 ■ 22140

19 ■ N/A

21 ■ N/A



# hurry SRAM / SHIMANO

## RS-12V



	<b>QUADRO</b>	TSW Hurry 2022, Direção Tapered Ø 44 x 55 mm, Canote 31.6 mm, Caixa central BSA 68 mm, Freio a disco Poust Mount, Eixo traseiro 135 mm, Alumínio 6061, Largura máxima de pneu: 29 x 2.2", Peso Máximo 120 kg (Peso do ciclista + Equipamentos)
	<b>SUSPENSÃO DIANTEIRA</b>	Rock Shox Judy   100 mm   Trava Remota  Ajuste de Preload   Off set 46 mm   OLD 100mm
	<b>SUSPENSÃO TRASEIRA</b>	N/A
	<b>MOVIMENTO DE DIREÇÃO</b>	Tapered   Semi-integrada (ZS)   Esfera
	<b>GUIDÃO</b>	X-Time   Reto   Alumínio   31.8 x 740 mm   9° de Backsweep
	<b>SUPORTE DE GUIDÃO</b>	X-Time   Ahead   70 mm   17°
	<b>MANOPLA</b>	MTB   TSW Light
	<b>CONJUNTO DE FREIO</b>	Shimano MT200   Disco   Hidráulico
	<b>DISCO DE FREIO</b>	Shimano RT-30   Center lock   160 mm
	<b>ARO/RAIO</b>	TSW T-9000 Tubeless Ready   ERD 599   29" - 622 X 22.5mm   Alumínio 6061   Dupla camada   32Furos   Ilhós   Válvula Fina ( Presta )   Raio Preto   Pneu 1.5" à 2.4"
	<b>CUBOS</b>	Shimano TX 505   Dianteiro/Traseiro   32 furos
	<b>PNEU / CÂMARA DE AR</b>	<b>Pneu:</b> Arisun Bona 29x2.10" <b>Câmara:</b> 29"   Válvula presta 48 mm
	<b>PEDIVELA</b>	SRAM SX 12V.   Single   1x12 velocidades   Coroa 32T. OFF Set 6mm Direct Mount  Estradiro - <b>ATENÇÃO: NÃO É DUB</b>
	<b>CORRENTE</b>	CN-M6100 SHIMANO 12V./SRAM SX 12V.
	<b>EIXO CENTRAL</b>	SRAM BSA/ Estradiro

	<b>CASSETTE</b>	Sram SX   11-50T   12 Velocidades
	<b>CÂMBIO DIANTEIRO</b>	N/A
	<b>CÂMBIO TRASEIRO</b>	Shimano Deore RD 6100  12 velocidades   Shadow plus
	<b>ALAVANCA</b>	Shimano Deore SL-M6100   12 Velocidades
	<b>SELIM</b>	TSW   MTB   Vazado   Trilho de aço
	<b>CANOTE</b>	X-Time   Alumínio   31.6 x 350 mm   Slim   Micro Ajuste
	<b>ABRAÇADEIRA</b>	X-Time   Alumínio   34.9 mm   Blocagem
	<b>PEDAL</b>	Inglês   Alumínio   Preto
	<b>URBANA</b>	✓
	<b>CICLOTURISMO</b>	✓
	<b>TRILHAS INTERMEDIÁRIAS</b>	✓
	<b>COMPETIÇÃO</b>	X
	<b>PESO APROXIMADO</b>	13,9 kg (17")

29" NACIONAL

15.5 ■ 21511

**ATENÇÃO!**

- Bicicleta 15.5" Equipada com pedivela de 170mm
- Bicicletas 17", 19" e 21" Equipadas com pedivela de 175mm
- Bicicletas 15.5" e 17" Equipadas com suporte de guidão 70mm/-17"
- Bicicletas 19" e 21" Equipadas com suporte de guidão 80mm/-17"

















# hurry SRAM / SHIMANO



## RS-12V



BICICLETAS

16

	<b>QUADRO</b>	TSW Hurry 2022, Direção Tapered Ø 44 x 55 mm, Canote 31.6 mm, Caixa central BSA 68 mm, Freio a disco Poust Mount, Eixo traseiro 135 mm, Alumínio 6061, Largura máxima de pneu: 29 x 2.2", Peso Máximo 120 kg (Peso do ciclista + Equipamentos)
	<b>SUSPENSÃO DIANTEIRA</b>	Rock Shox Judy   100 mm   Trava Remota   Ajuste de Preload   Off set 46 mm   OLD 100mm
	<b>SUSPENSÃO TRASEIRA</b>	N/A
	<b>MOVIMENTO DE DIREÇÃO</b>	Tapered   Semi-integrada (ZS)   Esfera
	<b>GUIDÃO</b>	X-Time   Reto   Alumínio   31.8 x 740 mm   9° de Backsweep
	<b>SUPORTE DE GUIDÃO</b>	X-Time   Ahead   70 mm   17°
	<b>MANOPLA</b>	MTB   TSW Light
	<b>CONJUNTO DE FREIO</b>	Shimano MT200   Disco   Hidráulico
	<b>DISCO DE FREIO</b>	Shimano RT-30   Center lock   160 mm
	<b>ARO/RAIO</b>	TSW T-9000 Tubeless Ready   ERD 599   29" - 622 X 22.5mm   Alumínio 6061   Dupla camada   32Furos   Ilhós   Válvula Fina ( Presta )   Raio Preto   Pneu 1.5" à 2.4"
	<b>CUBOS</b>	Shimano TX 505   Dianteiro/Traseiro   32 furos
	<b>PNEU / CÂMARA DE AR</b>	<b>Pneu:</b> Arisun Bona 29x2.10" <b>Câmara:</b> 29"   Válvula presta 48 mm
	<b>PEDIVELA</b>	SRAM SX 12V.   Single   1x12 velocidades   Coroa 32T. OFF Set 6mm Direct Mount   Estriado - <b>ATENÇÃO: NÃO É DUB</b>
	<b>CORRENTE</b>	CN-M6100 SHIMANO 12V./SRAM SX 12V.
	<b>EIXO CENTRAL</b>	SRAM BSA/ Estriado

	<b>CASSETTE</b>	Sram SX   11-50T   12 Velocidades
	<b>CÂMBIO DIANTEIRO</b>	N/A
	<b>CÂMBIO TRASEIRO</b>	Shimano Deore RD 6100   12 velocidades   Shadow plus
	<b>ALAVANCA</b>	Shimano Deore SL-M6100   12 Velocidades
	<b>SELIM</b>	TSW   MTB   Vazado   Trilho de aço
	<b>CANOTE</b>	X-Time   Alumínio   31.6 x 350 mm   Slim   Micro Ajuste
	<b>ABRAÇADEIRA</b>	X-Time   Alumínio   34.9 mm   Blocação
	<b>PEDAL</b>	Inglês   Alumínio   Preto
	<b>URBANA</b>	✓
	<b>CICLOTURISMO</b>	✓
	<b>TRILHAS INTERMEDIÁRIAS</b>	✓
	<b>COMPETIÇÃO</b>	X
	<b>PESO APROXIMADO</b>	13,9 kg (17")

29" NACIONAL

15.5 ■ 21512

**ATENÇÃO!**

- Bicicleta 15.5" Equipada com pedivela de 170mm
- Bicicletas 17", 19" e 21" Equipadas com pedivela de 175mm
- Bicicletas 15.5" e 17" Equipadas com suporte de guidão 70mm/-17"
- Bicicletas 19" e 21" Equipadas com suporte de guidão 80mm/-17"



FOTOS MERAMENTE ILUSTRATIVAS. AS INFORMAÇÕES/CONFIGURAÇÕES DE PRODUTOS PODERÃO SOFRER ALTERAÇÕES SEM AVISO PRÉVIO.

ENTRE EM CONTATO COM O SEU CONSULTOR OU FALE COM O NOSSO TIME DE TELEVENDAS PELO (33) 3277-3030.

# hurry **SRAM**/SHIMANO

## RS-12V



	<b>QUADRO</b>	TSW Hurry 2022, Direção Tapered Ø 44 x 55 mm, Canote 31.6 mm, Caixa central BSA 68 mm, Freio a disco Poust Mount, Eixo traseiro 135 mm, Alumínio 6061, Largura máxima de pneu: 29 x 2.2", Peso Máximo 120 kg (Peso do ciclista + Equipamentos)
	<b>SUSPENSÃO DIANTEIRA</b>	Rock Shox Judy   100 mm   Trava Remota  Ajuste de Preload   Off set 46 mm   OLD 100mm
	<b>SUSPENSÃO TRASEIRA</b>	N/A
	<b>MOVIMENTO DE DIREÇÃO</b>	Tapered   Semi-integrada (ZS)   Esfera
	<b>GUIDÃO</b>	X-Time   Reto   Alumínio   31.8 x 740 mm   9° de Backsweep
	<b>SUPORE DE GUIDÃO</b>	X-Time   Ahead   70 mm   17°
	<b>MANOPLA</b>	MTB   TSW Light
	<b>CONJUNTO DE FREIO</b>	Shimano MT200   Disco   Hidráulico
	<b>DISCO DE FREIO</b>	Shimano RT-30   Center lock   160 mm
	<b>ARO/RAIO</b>	TSW T-9000 Tubeless Ready   ERD 599   29" - 622 X 22.5mm   Alumínio 6061   Dupla camada   32Furos   Ilhós   Válvula Fina (Presta)   Raio Preto   Pneu 1.5" à 2.4"
	<b>CUBOS</b>	Shimano TX 505   Dianteiro/Traseiro   32 furos
	<b>PNEU / CÂMARA DE AR</b>	<b>Pneu:</b> Arisun Bona 29x2.10" <b>Câmara:</b> 29"   Válvula presta 48 mm
	<b>PEDIVELA</b>	SRAM SX 12V.   Single   1x12 velocidades   Coroa 32T. OFF Set 6mm Direct Mount   Estriado - <b>ATENÇÃO: NÃO É DUB</b>
	<b>CORRENTE</b>	SHIMANO 12 Velocidades   CN-M6100
	<b>EIXO CENTRAL</b>	SRAM BSA/ Estriado

	<b>CASSETTE</b>	Sram SX   11-50T   12 Velocidades
	<b>CÂMBIO DIANTEIRO</b>	N/A
	<b>CÂMBIO TRASEIRO</b>	Shimano Deore RD 6100  12 velocidades   Shadow plus
	<b>ALAVANCA</b>	Shimano Deore SL-M6100   12 Velocidades
	<b>SELIM</b>	TSW   MTB   Vazado   Trilho de aço
	<b>CANOTE</b>	X-Time   Alumínio   31.6 x 350 mm   Slim   Micro Ajuste
	<b>ABRACADEIRA</b>	X-Time   Alumínio   34.9 mm   Bloagem
	<b>PEDAL</b>	Inglês   Alumínio   Preto
	<b>URBANA</b>	✓
	<b>CICLOTURISMO</b>	✓
	<b>TRILHAS INTERMEDIÁRIAS</b>	✓
	<b>COMPETIÇÃO</b>	X
	<b>PESO APROXIMADO</b>	13,9 kg (17")

29" NACIONAL

15.5 ■ 21426

**ATENÇÃO!**

- Bicicleta 15.5" Equipada com pedivela de 170mm
- Bicicletas 17", 19" e 21" Equipadas com pedivela de 175mm
- Bicicletas 15.5" e 17" Equipadas com suporte de guidão 70mm/-17"
- Bicicletas 19" e 21" Equipadas com suporte de guidão 80mm/-17"



FOTOS MERAMENTE ILUSTRATIVAS. AS INFORMAÇÕES/CONFIGURAÇÕES DE PRODUTOS PODERÃO SOFRER ALTERAÇÕES SEM AVISO PRÉVIO.

ENTRE EM CONTATO COM O SEU CONSULTOR OU FALE COM O NOSSO TIME DE TELEVENDAS PELO (33) 3277-3030.



# hurry SRAM / SHIMANO

## RS-12V



BICICLETAS

TSW

18

	<b>QUADRO</b>	TSW Hurry 2022, Direção Tapered Ø 44 x 55 mm, Canote 31.6 mm, Caixa central BSA 68 mm, Freio a disco Poust Mount, Eixo traseiro 135 mm, Alumínio 6061, Largura máxima de pneu: 29 x 2.2", Peso Máximo 120 kg (Peso do ciclista + Equipamentos)
	<b>SUSPENSÃO DIANTEIRA</b>	Rock Shox Judy   100 mm   Trava Remota  Ajuste de Preload   Off set 46 mm   OLD 100mm
	<b>SUSPENSÃO TRASEIRA</b>	N/A
	<b>MOVIMENTO DE DIREÇÃO</b>	Tapered   Semi-integrada (ZS)   Esfera
	<b>GUIDÃO</b>	X-Time   Reto   Alumínio   31.8 x 740 mm   9° de Backsweep
	<b>SUORTE DE GUIDÃO</b>	X-Time   Ahead   70 mm   17°
	<b>MANOPLA</b>	MTB   TSW Light
	<b>CONJUNTO DE FREIO</b>	Shimano MT200   Disco   Hidráulico
	<b>DISCO DE FREIO</b>	Shimano RT-30   Center lock   160 mm
	<b>ARO/RAIO</b>	TSW T-9000 Tubeless Ready   ERD 599   29" - 622 X 22.5mm   Alumínio 6061   Dupla camada   32Furos   Ilhós   Válvula Fina (Presta)   Raio Preto   Pneu 1.5" à 2.4"
	<b>CUBOS</b>	Shimano TX 505   Dianteiro/Traseiro   32 furos
	<b>PNEU / CÂMARA DE AR</b>	<b>Pneu:</b> Arisun Bona 29x2.10" <b>Câmara:</b> 29"   Válvula presta 48 mm
	<b>PEDIVELA</b>	SRAM SX 12V.   Single   1x12 velocidades   Coroa 32T. OFF Set 6mm Direct Mount   Estriado - <b>ATENÇÃO: NÃO É DUB</b>
	<b>CORRENTE</b>	SHIMANO 12 Velocidades   CN-M6100
	<b>EIXO CENTRAL</b>	SRAM BSA/ Estriado

	<b>CASSETE</b>	Sram SX   11-50T   12 Velocidades
	<b>CÂMBIO DIANTEIRO</b>	N/A
	<b>CÂMBIO TRASEIRO</b>	Shimano Deore RD 6100  12 velocidades   Shadow plus
	<b>ALAVANCA</b>	Shimano Deore SL-M6100   12 Velocidades
	<b>SELIM</b>	TSW   MTB   Vazado   Trilho de aço
	<b>CANOTE</b>	X-Time   Alumínio   31.6 x 350 mm   Slim   Micro Ajuste
	<b>ABRACADEIRA</b>	X-Time   Alumínio   34.9 mm   Blocação
	<b>PEDAL</b>	Inglês   Alumínio   Preto
	<b>URBANA</b>	✓
	<b>CICLOTURISMO</b>	✓
	<b>TRILHAS INTERMEDIÁRIAS</b>	✓
	<b>COMPETIÇÃO</b>	X
	<b>PESO APROXIMADO</b>	13,9 kg (17")

29" NACIONAL

15.5 ■ 21424

**ATENÇÃO!**

- Bicicleta 15.5" Equipada com pedivela de 170mm
- Bicicletas 17", 19" e 21" Equipadas com pedivela de 175mm
- Bicicletas 15.5" e 17" Equipadas com suporte de guidão 70mm/-17"
- Bicicletas 19" e 21" Equipadas com suporte de guidão 80mm/-17"



FOTOS MERAMENTE ILUSTRATIVAS. AS INFORMAÇÕES/CONFIGURAÇÕES DE PRODUTOS PODERÃO SOFRER ALTERAÇÕES SEM AVISO PRÉVIO.

ENTRE EM CONTATO COM O SEU CONSULTOR OU FALE COM O NOSSO TIME DE TELEVENDAS PELO (33) 3277-3030.





# jump

ROCK SHOX JUDY 10v



29"  
WHEELS

	<b>QUADRO</b>	TSW JUMP 29", Alumínio 6061, Cabeamento interno, Direção Tapered Ø 44 x 55 mm, Freio a disco post mount, Caixa central BSA 73 mm, Eixo traseiro Boost 12 x 148mm, Canote 31.6 mm, Largura máxima do pneu 29 x 2.4", Peso máximo suportado de 120 kg
	<b>SUSPENSÃO DIANTEIRA</b>	29"   Rock Shox Judy   120 mm   Óleo/Ar   Tapered   15 x 110 mm   Off Set 51mm   Trava remota
	<b>SUSPENSÃO TRASEIRA</b>	N/A
	<b>MOVIMENTO DE DIREÇÃO</b>	Tapered   Semi-integrada (ZS)   Esfera   Caixa de aço
	<b>GUIDÃO</b>	X-Time   Alumínio   Reto   31.8 x 740 mm   9° Backsweep
	<b>SUPORE DE GUIDÃO</b>	X-Time   Alumínio   Ahead   70 mm   +-17°   Diâmetro 31.8mm
	<b>MANOPLA</b>	TSW Light
	<b>CONJUNTO DE FREIO</b>	Shimano Hidráulico MT 200   Disco
	<b>DISCO DE FREIO</b>	Shimano RT 30   160 mm   Center lock
	<b>ARO/RAIO</b>	Aro: TSW T10.000 Tubeless Ready, Parede Dupla, 29" 622 x 26mm, Altura do perfil: 19,5 mm, ERD 602mm, 32 furos, Alumínio 6061, Válvula Presta (Fina), Pneus: 1.9" até 2.6" / Raio: Preto, 2 mm, Niple preto
	<b>CUBOS</b>	<b>Dianteiro:</b> Boost   Shimano MT400B   Eixo de 15 mm   OLD 110 mm   32 furos / <b>Traseiro:</b> Boost   Shimano MT 410   OLD 148 mm   Eixo de 12 mm   32 furos   Free Hub Standard
	<b>PNEU / CÂMARA DE AR</b>	<b>Pneu</b> Arisun Mount Bona/Graham   Skinwall   29" / <b>Câmara de ar</b> Arisun   Válvula presta(Fina) 48 mm
	<b>PEDIVELA</b>	Shimano FC-M5100/ MT4100   Single   1x10 velocidades   Coroa 30 dentes   Braço 170mm   Deore

	<b>CORRENTE</b>	KMC 10 velocidades
	<b>MOVIMENTO CENTRAL</b>	Shimano BB52 / MT 500   Padrão BSA   Hollowtech II
	<b>CASSETE</b>	Shimano Deore CS-M4100   10 Velocidades   11-46T (11/13/15/18/21/24/28/32/37/46T)
	<b>CÂMBIO DIANTEIRO</b>	N/A
	<b>CÂMBIO TRASEIRO</b>	Shimano Deore RD-M5120   10 Velocidades
	<b>ALAVANCA</b>	Shimano Deore SL-M4100   10 Velocidades   Traseira
	<b>SELIM</b>	TSW   MTB   Vazado
	<b>CANOTE</b>	X-Time   Alumínio   31.6 x 350 mm   Slim   Dois Parafusos   Micro Ajuste
	<b>ABRACADEIRA</b>	X-Time   34.9 mm   Blocação
	<b>PEDAL</b>	Plataforma   MTB   Alumínio   Preto
	<b>URBANA</b>	✓
	<b>CICLOTURISMO</b>	✓
	<b>TRILHAS INTERMEDIÁRIAS</b>	✓
	<b>COMPETIÇÃO</b>	X

## 29" NACIONAL

15.5 ■ 20901

17 ■ 20904

19 ■ 20907

# jump

ROCK SHOX JUDY 10v

29" WHEELS



 <b>QUADRO</b>	TSW JUMP 29", Alumínio 6061, Cabeamento interno, Direção Tapered Ø 44 x 55 mm, Freio a disco post mount, Caixa central BSA 73 mm, Eixo traseiro Boost 12 x 148mm, Canote 31.6 mm, Largura máxima do pneu 29 x 2.4", Peso máximo suportado de 120 kg	 <b>CORRENTE</b>	KMC 10 velocidades
 <b>SUSPENSÃO DIANTEIRA</b>	29"   Rock Shox Judy   120 mm   Óleo/Ar   Tapered   15 x 110 mm   Off Set 51mm   Trava remota	 <b>MOVIMENTO CENTRAL</b>	Shimano BB52 / MT 500   Padrão BSA   Hollowtech II
 <b>SUSPENSÃO TRASEIRA</b>	N/A	 <b>CASSETE</b>	Shimano Deore CS-M4100   10 Velocidades   11-46T (11/13/15/18/21/24/28/32/37/46T)
 <b>MOVIMENTO DE DIREÇÃO</b>	Tapered   Semi-integrada (ZS)   Esfera   Caixa de aço	 <b>CÂMBIO DIANTEIRO</b>	N/A
 <b>GUIDÃO</b>	X-Time   Alumínio   Reto   31.8 x 740 mm   9° Backsweep	 <b>CÂMBIO TRASEIRO</b>	Shimano Deore RD-M5120   10 Velocidades
 <b>SUORTE DE GUIDÃO</b>	X-Time   Alumínio   Ahead   70 mm   +-17°   Diâmetro 31.8mm	 <b>ALAVANCA</b>	Shimano Deore SL-M4100   10 Velocidades   Traseira
 <b>MANOPLA</b>	TSW Light	 <b>SELIM</b>	TSW   MTB   Vazado
 <b>CONJUNTO DE FREIO</b>	Shimano Hidráulico MT 200   Disco	 <b>CANOTE</b>	X-Time   Alumínio   31.6 x 350 mm   Slim   Dois Parafusos   Micro Ajuste
 <b>DISCO DE FREIO</b>	Shimano RT 30   160 mm   Center lock	 <b>ABRAÇADEIRA</b>	X-Time   34.9 mm   Blocação
 <b>ARO/RAIO</b>	Aro: TSW T10.000 Tubeless Ready, Parede Dupla, 29" 622 x 26mm, Altura do perfil: 19,5 mm, ERD 602mm, 32 furos, Alumínio 6061, Válvula Presta (Fina), Pneus: 1.9" até 2.6" / Raio: Preto, 2 mm, Niple preto	 <b>PEDAL</b>	Plataforma   MTB   Alumínio   Preto
 <b>CUBOS</b>	<b>Dianteiro:</b> Boost   Shimano MT400B   Eixo de 15 mm   OLD 110 mm   32 furos / <b>Traseiro:</b> Boost   Shimano MT 410   OLD 148 mm   Eixo de 12 mm   32 furos   Free Hub Standard	 <b>URBANA</b>	✓
 <b>PNEU / CÂMARA DE AR</b>	<b>Pneu</b> Arisun Mount Bona/Graham   Skinwall   29" / <b>Câmara de ar</b> Arisun   Válvula presta(Fina) 48 mm	 <b>CICLOTURISMO</b>	✓
 <b>PEDIVELA</b>	Shimano FC-M5100/ MT4100   Single   1x10 velocidades   Coroa 30 dentes   Braço 170mm   Deore	 <b>TRILHAS INTERMEDIÁRIAS</b>	✓
		 <b>COMPETIÇÃO</b>	X

29" NACIONAL

15.5 20902





























17 20905

# jump

ROCK SHOX JUDY 10v

29"  
WHEELS



	<b>QUADRO</b>	TSW JUMP 29", Alumínio 6061, Cabeamento interno, Direção Tapered Ø 44 x 55 mm, Freio a disco post mount, Caixa central BSA 73 mm, Eixo traseiro Boost 12 x 148mm, Canote 31.6 mm, Largura máxima do pneu 29 x 2.4", Peso máximo suportado de 120 kg
	<b>SUSPENSÃO DIANTEIRA</b>	29"   Rock Shox Judy   120 mm   Óleo/Ar   Tapered   15 x 110 mm   Off Set 51mm   Trava remota
	<b>SUSPENSÃO TRASEIRA</b>	N/A
	<b>MOVIMENTO DE DIREÇÃO</b>	Tapered   Semi-integrada (ZS)   Esfera   Caixa de aço
	<b>GUIDÃO</b>	X-Time   Alumínio   Reto   31.8 x 740 mm   9° Backsweep
	<b>SUPORTE DE GUIDÃO</b>	X-Time   Alumínio   Ahead   70 mm   +-17°   Diâmetro 31.8mm
	<b>MANOPLA</b>	TSW Light
	<b>CONJUNTO DE FREIO</b>	Shimano Hidráulico MT 200   Disco
	<b>DISCO DE FREIO</b>	Shimano RT 30   160 mm   Center lock
	<b>ARO/RAIO</b>	Aro: TSW T10.000 Tubeless Ready, Parede Dupla, 29" 622 x 26mm, Altura do perfil: 19,5 mm, ERD 602mm, 32 furos, Alumínio 6061, Válvula Presta (Fina), Pneus: 1.9" até 2.6" / Raio: Preto, 2 mm, Niple preto
	<b>CUBOS</b>	<b>Dianteiro:</b> Boost   Shimano MT400B   Eixo de 15 mm   OLD 110 mm   32 furos / <b>Traseiro:</b> Boost   Shimano MT 410   OLD 148 mm   Eixo de 12 mm   32 furos   Free Hub Standard
	<b>PNEU / CÂMARA DE AR</b>	<b>Pneu</b> Arisun Mount Bona/Graham   Skinwall   29" / <b>Câmara de ar</b> Arisun   Válvula presta(Fina) 48 mm
	<b>PEDIVELA</b>	Shimano FC-M5100/ MT4100   Single   1x10 velocidades   Coroa 30 dentes   Braço 170mm   Deore
	<b>CORRENTE</b>	KMC 10 velocidades
	<b>MOVIMENTO CENTRAL</b>	Shimano BB52 / MT 500   Padrão BSA   Hollowtech II
	<b>CASSETE</b>	Shimano Deore CS-M4100   10 Velocidades   11-46T (11/13/15/18/21/24/28/32/37/46T)
	<b>CÂMBIO DIANTEIRO</b>	N/A
	<b>CÂMBIO TRASEIRO</b>	Shimano Deore RD-M5120   10 Velocidades
	<b>ALAVANCA</b>	Shimano Deore SL-M4100   10 Velocidades   Traseira
	<b>SELIM</b>	TSW   MTB   Vazado
	<b>CANOTE</b>	X-Time   Alumínio   31.6 x 350 mm   Slim   Dois Parafusos   Micro Ajuste
	<b>ABRAÇADEIRA</b>	X-Time   34.9 mm   Blocação
	<b>PEDAL</b>	Plataforma   MTB   Alumínio   Preto
	<b>URBANA</b>	✓
	<b>CICLOTURISMO</b>	✓
	<b>TRILHAS INTERMEDIÁRIAS</b>	✓
	<b>COMPETIÇÃO</b>	X
<b>29" NACIONAL</b>		
15.5		20903
17		20906
19		20908
21		N/A













# jump

Linha com Tapered

29"  
WHEELS



	<b>QUADRO</b>	TSW Jump Plus 2022   Direção Tapered Ø 44 x55 mm   Canote 31.6 mm   Caixa central BSA 68 mm   Freio a disco Poust Mount   Eixo traseiro 135 mm   Alumínio 6061   Largura máxima de pneu: 29 x 2.2"   Peso Máximo 120 kg
	<b>SUSPENSÃO DIANTEIRA</b>	SR Suntour XCM 30   Tapered Ahead Set   Eixo de 9 mm   Trava Remota   Ajuste de Preload
	<b>SUSPENSÃO TRASEIRA</b>	N/A
	<b>MOVIMENTO DE DIREÇÃO</b>	Tapered   Semi-integrada (ZS)   Esfera
	<b>GUIDÃO</b>	X-Time   Reto   Alumínio   31.8 x 740 mm   9° de Backsweep
	<b>SUORTE DE GUIDÃO</b>	X-Time   Ahead   70 mm   17°
	<b>MANOPLA</b>	MTB   TSW Light
	<b>CONJUNTO DE FREIO</b>	Shimano MT200   Disco   Hidráulico
	<b>DISCO DE FREIO</b>	Shimano RT-10   Center lock   160 mm
	<b>ARO/RAIO</b>	TSW T-9000 <b>Tubeless Ready</b>   29"   Alumínio   Dupla camada   32 furos   Ilhós   Válvula Fina ( Presta )   Raio Preto
	<b>CUBOS</b>	Shimano TX 505   Dianteiro/Traseiro   32 furos
	<b>PNEU / CÂMARA DE AR</b>	<b>Pneu:</b> Arisun Bona/Graham 29x2.10"   <b>Câmara:</b> 29"   Válvula presta 48 mm
	<b>PEDIVELA</b>	Shimano MT 5100/MT4100   Single   1x10 velocidades   Coroa 30 dentes
	<b>CORRENTE</b>	10 Velocidades   KMC
	<b>MOVIMENTO CENTRAL</b>	Shimano BB52/MT500
	<b>CASSETE</b>	Shimano   10 velocidades   11-46T

	<b>CÂMBIO DIANTEIRO</b>	N/A
	<b>CÂMBIO TRASEIRO</b>	Shimano RD-M5120   10 velocidades
	<b>ALAVANCA</b>	Shimano Deore SL-M4100   10 velocidades   Traseira
	<b>SELIM</b>	TSW   MTB   Vazado
	<b>CANOTE</b>	X-Time   Alumínio   31.6 x 350 mm   Slim   Micro Ajuste
	<b>ABRAÇADEIRA</b>	X-Time   Alumínio   34.9 mm   Blocagem
	<b>PEDAL</b>	Inglês   Alumínio   Preto
	<b>URBANA</b>	✓
	<b>CICLOTURISMO</b>	✓
	<b>TRILHAS INTERMEDIÁRIAS</b>	✓
	<b>COMPETIÇÃO</b>	X
	<b>PESO APROXIMADO</b>	14.18 kg (17")

29" NACIONAL

15.5 ■ 20892

# jump

Linha com Tapered

29" WHEELS



	<b>QUADRO</b>	TSW Jump Plus 2022   Direção Tapered Ø 44 x55 mm   Canote 31.6 mm   Caixa central BSA 68 mm   Freio a disco Poust Mount   Eixo traseiro 135 mm   Alumínio 6061   Largura máxima de pneu: 29 x 2.2"   Peso Máximo 120 kg
	<b>SUSPENSÃO DIANTEIRA</b>	SR Suntour XCM 30   Tapered Ahead Set   Eixo de 9 mm   Trava Remota   Ajuste de Preload
	<b>SUSPENSÃO TRASEIRA</b>	N/A
	<b>MOVIMENTO DE DIREÇÃO</b>	Tapered   Semi-integrada (ZS)   Esfera
	<b>GUIDÃO</b>	X-Time   Reto   Alumínio   31.8 x 740 mm   9° de Backsweep
	<b>SUPOORTE DE GUIDÃO</b>	X-Time   Ahead   70 mm   17°
	<b>MANOPLA</b>	MTB   TSW Light
	<b>CONJUNTO DE FREIO</b>	Shimano MT200   Disco   Hidráulico
	<b>DISCO DE FREIO</b>	Shimano RT-10   Center lock   160 mm
	<b>ARO/RAIO</b>	TSW T-9000 <b>Tubeless Ready</b>   29"   Alumínio   Dupla camada   32 furos   Ilhós   Válvula Fina ( Presta )   Raio Preto
	<b>CUBOS</b>	Shimano TX 505   Dianteiro/Traseiro   32 furos
	<b>PNEU / CÂMARA DE AR</b>	<b>Pneu:</b> Arisun Bona/Graham 29x2.10"   <b>Câmara:</b> 29"   Válvula presta 48 mm
	<b>PEDIVELA</b>	Shimano MT 5100/MT4100   Single   1x10 velocidades   Coroa 30 dentes
	<b>CORRENTE</b>	10 Velocidades   KMC
	<b>MOVIMENTO CENTRAL</b>	Shimano BB52/MT500
	<b>CASSETE</b>	Shimano   10 velocidades   11-46T

	<b>CÂMBIO DIANTEIRO</b>	N/A
	<b>CÂMBIO TRASEIRO</b>	Shimano RD-M5120   10 velocidades
	<b>ALAVANCA</b>	Shimano Deore SL-M4100   10 velocidades   Traseira
	<b>SELIM</b>	TSW   MTB   Vazado
	<b>CANOTE</b>	X-Time   Alumínio   31.6 x 350 mm   Slim   Micro Ajuste
	<b>ABRAÇADEIRA</b>	X-Time   Alumínio   34.9 mm   Blocagem
	<b>PEDAL</b>	Inglês   Alumínio   Preto
	<b>URBANA</b>	✓
	<b>CICLOTURISMO</b>	✓
	<b>TRILHAS INTERMEDIÁRIAS</b>	✓
	<b>COMPETIÇÃO</b>	X
	<b>PESO APROXIMADO</b>	14.18 kg (17")

29" NACIONAL

17 ■ 20896



# jump

ROCK SHOX JUDY

29"  
WHEELS



BICICLETAS

TSW

26

	<b>QUADRO</b>	TSW Jump 2022, Direção Tapered Ø 44 x 55 mm, Canote 31.6 mm, Caixa central BSA 68 mm, Freio a disco Poust Mount, Eixo traseiro 135 mm, Alumínio 6061, Largura máxima de pneu: 29 x 2.2", Peso Máximo 120 kg
	<b>SUSPENSÃO DIANTEIRA</b>	Rock Shox Judy   100 mm   Trava Remota   Ajuste de Preload   Off set 46 mm   OLD 100mm
	<b>SUSPENSÃO TRASEIRA</b>	N/A
	<b>MOVIMENTO DE DIREÇÃO</b>	Tapered   Semi-integrada (ZS)   Esfera
	<b>GUIDÃO</b>	X-Time   Reto   Alumínio   31.8 x 740 mm   9° de Backsweep
	<b>SUORTE DE GUIDÃO</b>	X-Time   Ahead   70 mm   17°
	<b>MANOPLA</b>	MTB   TSW Light
	<b>CONJUNTO DE FREIO</b>	Shimano MT200   Disco   Hidráulico
	<b>DISCO DE FREIO</b>	Shimano MT200   Disco   Hidráulico
	<b>ARO/RAIO</b>	TSW T-9000 <b>Tubeless Ready</b>   29"   Alumínio   Dupla camada   32Furos   Ilhós   Válvula Fina ( Presta )   Raio Preto
	<b>CUBOS</b>	Shimano TX 505   Dianteiro/Traseiro   32 furos
	<b>PNEU / CÂMARA DE AR</b>	<b>Pneu:</b> Arisun Bona/Graham 29x2.10" <b>Câmara:</b> 29"   Válvula presta 48 mm
	<b>PEDIVELA</b>	Shimano MT5100/ MT4100   Single   1x10 velocidades   Coroa 30 dentes
	<b>CORRENTE</b>	10 Velocidades   KMC
	<b>MOVIMENTO CENTRAL</b>	Shimano BB52/ MT 500
	<b>CASSETE</b>	Shimano   10 Velocidades   11-46T

	<b>CÂMBIO DIANTEIRO</b>	N/A
	<b>CÂMBIO TRASEIRO</b>	Shimano RD-M5120   10 Velocidades
	<b>ALAVANCA</b>	Shimano Deore SL-M4100   10 Velocidades   Traseira
	<b>SELIM</b>	TSW   MTB   Vazado
	<b>CANOTE</b>	X-Time   Alumínio   31.6 x 350 mm   Slim   Micro Ajuste
	<b>ABRACADEIRA</b>	X-Time   Alumínio   34.9 mm   Blocagem
	<b>PEDAL</b>	Inglês   Alumínio   Preto
	<b>URBANA</b>	✓
	<b>CICLOTURISMO</b>	✓
	<b>TRILHAS INTERMEDIÁRIAS</b>	✓
	<b>COMPETIÇÃO</b>	X
	<b>PESO APROXIMADO</b>	14.18 kg (17")

29" NACIONAL

15.5  21470

FOTOS MERAMENTE ILUSTRATIVAS. AS INFORMAÇÕES/CONFIGURAÇÕES DE PRODUTOS PODERÃO SOFRER ALTERAÇÕES SEM AVISO PRÉVIO.

ENTRE EM CONTATO COM O SEU CONSULTOR OU FALE COM O NOSSO TIME DE TELEVENDAS PELO (33) 3277-3030.

# jump

ROCK SHOX JUDY

29"  
WHEELS



QUADRO

TSW Jump 2022, Direção Tapered Ø 44 x 55 mm, Canote 31.6 mm, Caixa central BSA 68 mm, Freio a disco Poust Mount, Eixo traseiro 135 mm, Alumínio 6061, Largura máxima de pneu: 29 x 2.2", Peso Máximo 120 kg



SUSPENSÃO DIANTEIRA

Rock Shox Judy | 100 mm | Trava Remota | Ajuste de Preload | Off set 46 mm | OLD 100mm



SUSPENSÃO TRASEIRA

N/A



MOVIMENTO DE DIREÇÃO

Tapered | Semi-integrada (ZS) | Esfera



GUIDÃO

X-Time | Reto | Alumínio | 31.8 x 740 mm | 9° de Backsweep



SUPORTE DE GUIDÃO

X-Time | Ahead | 70 mm | 17°



MANOPLA

MTB | TSW Light



CONJUNTO DE FREIO

Shimano MT200 | Disco | Hidráulico



DISCO DE FREIO

Shimano MT200 | Disco | Hidráulico



ARO/RAIO

TSW T-9000 **Tubeless Ready** | 29" | Alumínio | Dupla camada | 32Furos | Ilhós | Válvula Fina ( Presta ) | Raio Preto



CUBOS

Shimano TX 505 | Dianteiro/Traseiro | 32 furos



PNEU / CÂMARA DE AR

**Pneu:** Arisun Bona/Graham 29x2.10"  
**Câmara:** 29" | Válvula presta 48 mm



PEDIVELA

Shimano MT5100/ MT4100 | Single | 1x10 velocidades | Coroa 30 dentes



CORRENTE

10 Velocidades | KMC



MOVIMENTO CENTRAL

Shimano BB52/ MT 500



CASSETTE

Shimano | 10 Velocidades | 11-46T



CÂMBIO DIANTEIRO

N/A



CÂMBIO TRASEIRO

Shimano RD-M5120 | 10 Velocidades



ALAVANCA

Shimano Deore SL-M4100 | 10 Velocidades | Traseira



SELIM

TSW | MTB | Vazado



CANOTE

X-Time | Alumínio | 31.6 x 350 mm | Slim | Micro Ajuste



ABRAÇADEIRA

X-Time | Alumínio | 34.9 mm | Bloccagem



PEDAL

Inglês | Alumínio | Preto



URBANA

✓



CICLOTURISMO

✓



TRILHAS INTERMEDIÁRIAS

✓



COMPETIÇÃO

X



PESO APROXIMADO

14.18 kg (17")

29" NACIONAL

15.5  21471

17  N/A

19  -

21  -

# jump









ROCK SHOX JUDY

29"  
WHEELS



BICICLETAS

	<b>QUADRO</b>	TSW Jump 2022, Direção Tapered Ø 44 x 55 mm, Canote 31.6 mm, Caixa central BSA 68 mm, Freio a disco Poust Mount, Eixo traseiro 135 mm, Alumínio 6061, Largura máxima de pneu: 29 x 2.2", Peso Máximo 120 kg
	<b>SUSPENSÃO DIANTEIRA</b>	Rock Shox Judy   100 mm   Trava Remota   Ajuste de Preload   Off set 46 mm   OLD 100mm
	<b>SUSPENSÃO TRASEIRA</b>	N/A
	<b>MOVIMENTO DE DIREÇÃO</b>	Tapered   Semi-integrada (ZS)   Esfera
	<b>GUIDÃO</b>	X-Time   Reto   Alumínio   31.8 x 740 mm   9° de Backsweep
	<b>SUORTE DE GUIDÃO</b>	X-Time   Ahead   70 mm   17°
	<b>MANOPLA</b>	MTB   TSW Light
	<b>CONJUNTO DE FREIO</b>	Shimano MT200   Disco   Hidráulico
	<b>DISCO DE FREIO</b>	Shimano MT200   Disco   Hidráulico
	<b>ARO/RAIO</b>	TSW T-9000 Tubeless Ready   29"   Alumínio   Dupla camada   32Furos   Ilhós   Válvula Fina ( Presta )   Raio Preto
	<b>CUBOS</b>	Shimano TX 505   Dianteiro/Traseiro   32 furos
	<b>PNEU / CÂMARA DE AR</b>	<b>Pneu:</b> Arisun Bona/Graham 29x2.10" <b>Câmara:</b> 29"   Válvula presta 48 mm
	<b>PEDIVELA</b>	Shimano MT5100/ MT4100   Single   1x10 velocidades   Coroa 30 dentes
	<b>CORRENTE</b>	10 Velocidades   KMC
	<b>MOVIMENTO CENTRAL</b>	Shimano BB52/ MT 500
	<b>CASSETE</b>	Shimano   10 Velocidades   11-46T

	<b>CÂMBIO DIANTEIRO</b>	N/A
	<b>CÂMBIO TRASEIRO</b>	Shimano RD-M5120   10 Velocidades
	<b>ALAVANCA</b>	Shimano Deore SL-M4100   10 Velocidades   Traseira
	<b>SELIM</b>	TSW   MTB   Vazado
	<b>CANOTE</b>	X-Time   Alumínio   31.6 x 350 mm   Slim   Micro Ajuste
	<b>ABRAÇADEIRA</b>	X-Time   Alumínio   34.9 mm   Bloccagem
	<b>PEDAL</b>	Inglês   Alumínio   Preto
	<b>URBANA</b>	✓
	<b>CICLOTURISMO</b>	✓
	<b>TRILHAS INTERMEDIÁRIAS</b>	✓
	<b>COMPETIÇÃO</b>	X
	<b>PESO APROXIMADO</b>	14.18 kg (17")

29" NACIONAL

17  21475

19  N/A

FOTOS MERAMENTE ILUSTRATIVAS. AS INFORMAÇÕES/CONFIGURAÇÕES DE PRODUTOS PODERÃO SOFRER ALTERAÇÕES SEM AVISO PRÉVIO.

ENTRE EM CONTATO COM O SEU CONSULTOR OU FALE COM O NOSSO TIME DE TELEVENDAS PELO (33) 3277-3030.



# stamina



	<b>QUADRO</b>	TSW STAMINA 2021/2022   Cabeamento interno   Direção Mega Over Ø 44 mm   Canote 31.6 mm   Caixa central BSA 68 mm   Freio a disco Poust Mount   Eixo traseiro 135 mm   Alumínio 6061   Largura máxima de pneu: 29 x 2.2"   Peso Máximo 120 kg
	<b>SUSPENSÃO DIANTEIRA</b>	SR Suntour XCM 30   Ahead   Eixo de 9 mm   Trava Remota   Ajuste de Preload
	<b>SUSPENSÃO TRASEIRA</b>	N/A
	<b>MOVIMENTO DE DIREÇÃO</b>	Mega Over
	<b>GUIDÃO</b>	X-Time   Reto   Alumínio   31.8 x 740 mm   9° de Backsweep
	<b>SUPOORTE DE GUIDÃO</b>	X-Time   Ahead   70 mm   17°
	<b>MANOPLA</b>	MTB   TSW Light
	<b>CONJUNTO DE FREIO</b>	Shimano MT200   Disco   Hidráulico
	<b>DISCO DE FREIO</b>	Shimano RT-10   Center lock   160 mm
	<b>ARO/RAIO</b>	Aro: TSW T6300   Freio a disco   32 furos   Parede Dupla   29" - 622 x 19 mm / Raio: Preto   292/293 x 2.0 mm   Niple
	<b>CUBOS</b>	Shimano TX 505   Dianteiro/Traseiro   32 furos
	<b>PNEU / CÂMARA DE AR</b>	<b>Pneu:</b> Arisun Bona/Graham 29x2.10"   <b>Câmara:</b> 29"   Válvula presta 48 mm
	<b>PEDIVELA</b>	Shimano MT2102   Duplo 22/36T
	<b>CORRENTE</b>	KMC   9 Velocidades
	<b>EIXO CENTRAL</b>	Shimano MT 500
	<b>CASSETTE</b>	Shimano   9 Velocidades   11-36T
	<b>CÂMBIO DIANTEIRO</b>	Shimano Alivio M3120

	<b>CÂMBIO TRASEIRO</b>	Shimano Alivio RD-M3100   9 Velocidades
	<b>ALAVANCA</b>	2x9 Velocidades   <b>Dianteira:</b> Shimano Alivio SL 310002   <b>Traseira:</b> Shimano Alívio SL-M3100
	<b>SELIM</b>	TSW   MTB   Vazado
	<b>CANOTE</b>	X-Time   Alumínio   31,6 x 350mm   Slim   Micro Ajuste
	<b>ABRACADEIRA</b>	X-Time   Alumínio   34.9 mm   Blocagem
	<b>PEDAL</b>	Inglês   Alumínio   Preto
	<b>URBANA</b>	✓
	<b>CICLOTURISMO</b>	✓
	<b>TRILHAS INTERMEDIÁRIAS</b>	✓
	<b>COMPETIÇÃO</b>	X
	<b>PESO APROXIMADO</b>	14.4kg (17")

29" NACIONAL

15.5 ■ N/A/21415



# hunch

## PLUS



BICICLETAS

TSW

32

	<b>QUADRO</b>	TSW Hunch Plus 29"   Alumínio 6061   Direção Mega Over 44 mm   Freio a Disco   Eixo traseiro 135 mm   Canote 17.2 mm   Largura máxima de Pneu 29" x 2.2"   Peso máximo até 120 kg
	<b>SUSPENSÃO DIANTEIRA</b>	TSW   Eixo de 9 mm   Ahead   Trava Remota
	<b>SUSPENSÃO TRASEIRA</b>	N/A
	<b>MOVIMENTO DE DIREÇÃO</b>	Mega Over
	<b>GUIDÃO</b>	X-Time   Reto   Alumínio   31.8 x 740 mm   9° Backsweep
	<b>SUPORTE DE GUIDÃO</b>	X-Time   Alumínio   80 mm   7°
	<b>MANOPLA</b>	MTB-TSW light
	<b>CONJUNTO DE FREIO</b>	Disco   Hidráulico   Shimano EF 505
	<b>DISCO DE FREIO</b>	Shimano RT-10   Center lock   160 mm
	<b>ARO/RAIO</b>	Aro: TSW T6300   Freio a disco   32 furos   Parede Dupla   29" - 622 x 19 mm / Raio: Preto   292/293 x 2.0 mm   Niple
	<b>CUBOS</b>	Shimano TX 505   Dianteiro/Traseiro   32 Furos   Alumínio
	<b>PNEU / CÂMARA DE AR</b>	<b>Pneu:</b> Arisun Bona/Graham 29"   <b>Câmara:</b> 29"   Válvula Presta 48 mm
	<b>PEDIVELA</b>	Shimano MT-210   Triplo   22/30/40T
	<b>CORRENTE</b>	KMC   9 Velocidades
	<b>EIXO CENTRAL</b>	Shimano MT500
	<b>CASSETTE</b>	Shimano   9 Velocidades   11-36T
	<b>CÂMBIO DIANTEIRO</b>	Shimano M2000
	<b>CÂMBIO TRASEIRO</b>	Shimano Alivio RD-M3100   9 Velocidades

	<b>ALAVANCA / MANETE</b>	Alavanca/Manete de freio   Shimano EF-505 27 velocidades
	<b>SELIM</b>	MTB   TSW   Vazado
	<b>CANOTE</b>	X-Time   27.2 x 400 mm   Slim   Micro Ajuste
	<b>ABRAÇADEIRA</b>	X-Time   31.8 mm   Blocação
	<b>PEDAL</b>	Plataforma   MTB   Alumínio
	<b>URBANA</b>	✓
	<b>CICLOTURISMO</b>	✓
	<b>TRILHAS INTERMEDIÁRIAS</b>	X
	<b>COMPETIÇÃO</b>	X
	<b>PESO APROXIMADO</b>	15.07 kg (17")

29" NACIONAL

15.5 21406









FOTOS MERAMENTE ILUSTRATIVAS. AS INFORMAÇÕES/CONFIGURAÇÕES DE PRODUTOS PODERÃO SOFRER ALTERAÇÕES SEM AVISO PRÉVIO.

ENTRE EM CONTATO COM O SEU CONSULTOR OU FALE COM O NOSSO TIME DE TELEVENDAS PELO (33) 3277-3030.

# hunch



	<b>QUADRO</b>	TSW Hunch 29"   Alumínio 6061   Direção Mega Over 44 mm   Freio a Disco   Eixo traseiro 135 mm   Canote 17.2 mm   Largura máxima de Pneu 29" x 2.2"   Peso máximo até 120 kg
	<b>SUSPENSÃO DIANTEIRA</b>	TSW   Eixo de 9 mm   Ahead   Trava Remota
	<b>SUSPENSÃO TRASEIRA</b>	N/A
	<b>MOVIMENTO DE DIREÇÃO</b>	Mega Over
	<b>GUIDÃO</b>	X-Time   Reto   Alumínio   31.8 x 740 mm   9° Backsweep
	<b>SUPORTE DE GUIDÃO</b>	X-Time   Alumínio   80 mm   7°
	<b>MANOPLA</b>	MTB-TSW light
	<b>CONJUNTO DE FREIO</b>	Disco   Hidráulico   Shimano EF 505
	<b>DISCO DE FREIO</b>	Shimano RT-10   Center lock   160 mm
	<b>ARO/RAIO</b>	Aro: TSW T6300   Freio a disco   32 furos   Parede Dupla   29" - 622 x 19 mm / Raio: Preto   292/293 x 2.0 mm   Niple
	<b>CUBOS</b>	Shimano TX 505   Dianteiro/Traseiro   32 Furos   Alumínio
	<b>PNEU / CÂMARA DE AR</b>	<b>Pneu:</b> Arisun Bona/Graham 29"   <b>Câmara:</b> 29"   Válvula Presta 48 mm
	<b>PEDIVELA</b>	Shimano TY-301   Triplo   24/34/42T
	<b>CORRENTE</b>	KMC   8 Velocidades
	<b>EIXO CENTRAL</b>	34.7   122.5 mm
	<b>CASSETE</b>	Shimano   8 Velocidades   11-34T
	<b>CÂMBIO DIANTEIRO</b>	Shimano M FD-M313   34.9 mm Com adaptador   Abraçadeira alta
	<b>CÂMBIO TRASEIRO</b>	Shimano Altus M310   8 Velocidades

	<b>ALAVANCA / MANETE</b>	Alavanca/Manete de freio   Shimano EF-505 24 velocidades
	<b>SELIM</b>	MTB   TSW   Vazado
	<b>CANOTE</b>	X-Time   27.2 x 400 mm   Slim
	<b>ABRAÇADEIRA</b>	X-Time   31.8 mm   Blocagem
	<b>PEDAL</b>	Plataforma   MTB   Alumínio
	<b>URBANA</b>	✓
	<b>CICLOTURISMO</b>	✓
	<b>TRILHAS INTERMEDIÁRIAS</b>	X
	<b>COMPETIÇÃO</b>	X

## 29" NACIONAL

15.5  16575

17  N/A



# hunch



29

	<b>QUADRO</b>	TSW Hunch 29"   Alumínio 6061   Direção Mega Over 44 mm   Freio a Disco   Eixo traseiro 135 mm   Canote 17.2 mm   Largura máxima de Pneu 29" x 2.2"   Peso máximo até 120 kg
	<b>SUSPENSÃO DIANTEIRA</b>	TSW   Eixo de 9 mm   Ahead   Trava Remota
	<b>SUSPENSÃO TRASEIRA</b>	N/A
	<b>MOVIMENTO DE DIREÇÃO</b>	Mega Over
	<b>GUIDÃO</b>	X-Time   Reto   Alumínio   31.8 x 740 mm   9° Backsweep
	<b>SUPOORTE DE GUIDÃO</b>	X-Time   Alumínio   80 mm   7°
	<b>MANOPLA</b>	MTB-TSW light
	<b>CONJUNTO DE FREIO</b>	Disco   Hidráulico   Shimano EF 505
	<b>DISCO DE FREIO</b>	Shimano RT-10   Center lock   160 mm
	<b>ARO/RAIO</b>	Aro: TSW T6300   Freio a disco   32 furos   Parede Dupla   29" - 622 x 19 mm / Raio: Preto   292/293 x 2.0 mm   Niple
	<b>CUBOS</b>	Shimano TX 505   Dianteiro/Traseiro   32 Furos   Alumínio
	<b>PNEU / CÂMARA DE AR</b>	<b>Pneu:</b> Arisun Bona/Graham 29"   <b>Câmara:</b> 29"   Válvula Presta 48 mm
	<b>PEDIVELA</b>	Shimano TY-301   Triplo   24/34/42T
	<b>CORRENTE</b>	KMC   8 Velocidades
	<b>EIXO CENTRAL</b>	34.7   122.5 mm
	<b>CASSETTE</b>	Shimano   8 Velocidades   11-34T
	<b>CÂMBIO DIANTEIRO</b>	Shimano M FD-M313   34.9 mm Com adaptador   Abraçadeira alta
	<b>CÂMBIO TRASEIRO</b>	Shimano Altus M310   8 Velocidades

	<b>ALAVANCA / MANETE</b>	Alavanca/Manete de freio   Shimano EF-505 24 velocidades
	<b>SELIM</b>	MTB   TSW   Vazado
	<b>CANOTE</b>	X-Time   27.2 x 400 mm   Slim
	<b>ABRÇAÇADEIRA</b>	X-Time   31.8 mm   Blocagem
	<b>PEDAL</b>	Plataforma   MTB   Alumínio
	<b>URBANA</b>	✓
	<b>CICLOTURISMO</b>	✓
	<b>TRILHAS INTERMEDIÁRIAS</b>	X
	<b>COMPETIÇÃO</b>	X

## 29" NACIONAL

15.5 16576



17 N/A

21 N/A

# hunch

20"  
WHEELS



	<b>QUADRO</b>	TSW Hunch aro 20"   Alumínio 6061   Direção Mega Over 44 mm semi-integrada   Freio a Disco Post Mount   Eixo traseiro 135 mm   Canote 27.2 mm   Largura máxima de pneu 20" x 2.2"
	<b>SUSPENSÃO DIANTEIRA</b>	Suspensão TSW aro 20"   Eixo de 9 mm   Ahead Set   Trava remota   OLD 100 mm   Kraw alumínio   Lower Leg de aço
	<b>SUSPENSÃO TRASEIRA</b>	N/A
	<b>MOVIMENTO DE DIREÇÃO</b>	Direção mega over   Semi-integrada   Esferada   44 mm
	<b>GUIDÃO</b>	X-Time   Alumínio   Reto   31.8 x 650 mm   9° backsweep
	<b>SUORTE DE GUIDÃO</b>	X-Time   Ahead   Alumínio   31.8 x 70 mm   +/-17°
	<b>MANOPLA</b>	MTB   Preta   TSW light
	<b>CONJUNTO DE FREIO</b>	X-Time   Hidráulico   Abraçadeira   Reservatório de alumínio   Óleo mineral   Caliper 2 pistões
	<b>DISCO DE FREIO</b>	Shimano   160 mm   Center-Lock   Aço   RT-10
	<b>ARO/RAIO</b>	<b>Aro:</b> TSW T3000   Freio a disco   32 furos   Parede dupla   <b>Aro 20" Raio:</b> Preto   185 x 2.0 mm   Niple preto aço
	<b>CUBOS</b>	Shimano TX 505   <b>Dianteiro/Traseiro:</b> 32 Furos   Alumínio   Eixo 9 mm
	<b>PNEU / CÂMARA DE AR</b>	<b>Pneu:</b> 20 X 2.10 Skinwall Cutting Edge Arisun <b>Câmara:</b> Arisun 20"   Válvula americana
	<b>PEDIVELA</b>	X-Time ponta quadrada   Single   Coroa 32D aço   Braço alumínio   Comprimento do braço 127mm
	<b>CORRENTE</b>	Corrente 8S   KMC   Com Power Link

	<b>EIXO CENTRAL</b>	34.7 x 115 mm   Ponta quadrada   Aço   Rolamentos
	<b>CASSETTE</b>	Shimano CS-HG31-8   Mega Ranger   11/34D (11-13-15-17-20-23-26-34T)
	<b>CÂMBIO DIANTEIRO</b>	N/A
	<b>CÂMBIO TRASEIRO</b>	Shimano Altus M310   8 velocidades
	<b>ALAVANCA / MANETE</b>	Shimano SL-M315-8R   Rapide Fire PLUS   MTB 8-speed
	<b>SELIM</b>	Selim MTB   TSW   Vazado
	<b>CANOTE</b>	X-Time   Alumínio   27.2 x 350 mm   Carrinho   Parafuso único
	<b>ABRAÇADEIRA</b>	X-Time   Alumínio   31.8   Blocação
	<b>PEDAL</b>	Inglês   Preto   Alumínio
	<b>URBANA</b>	✓
	<b>CICLOTURISMO</b>	✓
	<b>TRILHAS INTERMEDIÁRIAS</b>	X
	<b>COMPETIÇÃO</b>	X
	<b>PESO APROXIMADO</b>	11.28 kg (10.5")





























29" NACIONAL

10.5  17199

# hunch

20"  
WHEELS



 <b>QUADRO</b>	TSW Hunch aro 20"   Alumínio 6061   Direção Mega Over 44 mm semi-integrada   Freio a Disco Post Mount   Eixo traseiro 135 mm   Canote 27.2 mm   Largura máxima de pneu 20" x 2.2"	 <b>EIXO CENTRAL</b>	34.7 x 115 mm   Ponta quadrada   Aço   Rolamentos
 <b>SUSPENSÃO DIANTEIRA</b>	Suspensão TSW aro 20"   Eixo de 9 mm   Ahead Set   Trava remota   OLD 100 mm   Kraw alumínio   Lower Leg de aço	 <b>CASSETE</b>	Shimano CS-HG31-8   Mega Ranger   11/34D (11-13-15-17-20-23-26-34T)
 <b>SUSPENSÃO TRASEIRA</b>	N/A	 <b>CÂMBIO DIANTEIRO</b>	Shimano Altus M310   8 velocidades
 <b>MOVIMENTO DE DIREÇÃO</b>	Direção mega over   Semi-integrada   Esferada   44 mm	 <b>CÂMBIO TRASEIRO</b>	N/A
 <b>GUIDÃO</b>	X-Time   Alumínio   Reto   31.8 x 650 mm   9° backsweep	 <b>ALAVANCA / MANETE</b>	Shimano SL-M315-8R   Rapide Fire PLUS   MTB 8-speed
 <b>SUPORE DE GUIDÃO</b>	X-Time   Ahead   Alumínio   31.8 x 70 mm   +/-17°	 <b>SELIM</b>	Selim MTB   TSW   Vazado
 <b>MANOPLA</b>	MTB   Preta   TSW light	 <b>CANOTE</b>	X-Time   Alumínio   27.2 x 350 mm   Carrinho   Parafuso único
 <b>CONJUNTO DE FREIO</b>	X-Time   Hidráulico   Abraçadeira   Reservatório de alumínio   Óleo mineral   Caliper 2 pistões	 <b>ABRAÇADEIRA</b>	X-Time   Alumínio   31.8   Blocagem
 <b>DISCO DE FREIO</b>	Shimano   160 mm   Center-Lock   Aço   RT-10	 <b>PEDAL</b>	Inglês   Preto   Alumínio
 <b>ARO/RAIO</b>	<b>Aro:</b> TSW T3000   Freio a disco   32 furos   Parede dupla   Aro 20" <b>Raio:</b> Preto   185 x 2.0 mm   Niple preto aço	 <b>URBANA</b>	✓
 <b>CUBOS</b>	Shimano TX 505   <b>Dianteiro/Traseiro:</b> 32 Furos   Alumínio   Eixo 9 mm	 <b>CICLOTURISMO</b>	✓
 <b>PNEU / CÂMARA DE AR</b>	<b>Pneu:</b> 20 X 2.10 Skinwall Cutting Edge Arisun <b>Câmara:</b> Arisun 20"   Válvula americana	 <b>TRILHAS INTERMEDIÁRIAS</b>	X
 <b>PEDIVELA</b>	X-Time ponta quadrada   Single   Coroa 32D aço   Braço alumínio   Comprimento do braço 127mm	 <b>COMPETIÇÃO</b>	X
 <b>CORRENTE</b>	Corrente 8S   KMC   Com Power Link	 <b>PESO APROXIMADO</b>	11.28 kg (10.5")

29" NACIONAL

10.5  17200



# ride+



	<b>QUADRO</b>	TSW Ride Plus   Alumínio 6061   Cabeamento interno   Direção mega over   Canote 27.2 mm   Central BSA   Geometria atualizada 2021
	<b>SUSPENSÃO DIANTEIRA</b>	TSW   Eixo 9 mm
	<b>SUSPENSÃO TRASEIRA</b>	N/A
	<b>MOVIMENTO DE DIREÇÃO</b>	Mega Over   Esferado
	<b>GUIDÃO</b>	Reto   Alumínio   31.8 x 740 mm   9° backsweep
	<b>SUPOORTE DE GUIDÃO</b>	Ahead   Alumínio   80 mm/7°
	<b>MANOPLA</b>	MTB
	<b>CONJUNTO DE FREIO</b>	Disco   Hidráulico   Shimano EF 505
	<b>DISCO DE FREIO</b>	Shimano   Center Lock   160 mm   RT-10
	<b>ARO/RAIO</b>	TSW T-5300   29"   32 furos
	<b>CUBOS</b>	<b>Dianteiro:</b> Shimano TX-505   Alumínio   32 furos   <b>Dianteiro/Traseiro(cassete)</b>
	<b>PNEU / CÂMARA DE AR</b>	<b>Pneu:</b> Arisun 29"   <b>Câmara:</b> 29"   Válvula americana
	<b>PEDIVELA</b>	Shimano TY-301   Engrenagem Tripla com braço   170 mm   24/34/42D.
	<b>CORRENTE</b>	KMC   7Velocidades
	<b>EIXO CENTRAL</b>	34.7 C/ ROL. 122.5mm
	<b>CASSETE</b>	HG 200   11-32D.   7 Velocidades
	<b>CÂMBIO DIANTEIRO</b>	TZ 500   Shimano   Dual
	<b>CÂMBIO TRASEIRO</b>	Shimano TY-500   7 Velocidades

	<b>ALAVANCA / MANETE</b>	Alavanca/Manete de freio   Shimano EF-505   21 velocidades
	<b>SELIM</b>	TSW MTB (vazado)
	<b>CANOTE</b>	TSW Alumínio   27.2 x 350 mm
	<b>ABRAÇADEIRA</b>	Alumínio   31.8   Blocagem
	<b>PEDAL</b>	Inglês   Nylon   Preto
	<b>URBANA</b>	✓
	<b>CICLOTURISMO</b>	✓
	<b>TRILHAS INTERMEDIÁRIAS</b>	X
	<b>COMPETIÇÃO</b>	X

## 29" NACIONAL

15.5 N/A

17.5 N/A

# ride

AQUI  
TEM

SHIMANO

QUALIDADE  
CONFIANÇA



#SEMPRESHIMANO



29" (29")

	<b>QUADRO</b>	MTB RIDE 29", Alumínio 6061, Cabeamento Interno, Direção mega over semi-integrada Ø 44 x 44 mm, Suporte de freio a disco standard, Caixa central BSA 68 mm, Eixo traseiro 9 x 135mm, Canote 27.2 mm, Largura máxima do pneu 29 x 2.2" com cravo baixo, Peso máximo suportado de 110 kg - PESO DO CICLISTA + ACESSÓRIOS
	<b>SUSPENSÃO DIANTEIRA</b>	29"   TSW   100 mm   Mola   Over head set   (OLD) 9 x 100 mm   Lower leg e garfo de aço
	<b>SUSPENSÃO TRASEIRA</b>	N/A
	<b>MOVIMENTO DE DIREÇÃO</b>	Mega over semi-integrada Ø 44 x 44 mm   Esfera   Caixa de aço
	<b>GUIDÃO</b>	X-Time   Alumínio   Reto   31.8 x 740 mm   9° Backsweep
	<b>SUporte DE GUIDÃO</b>	X-Time   Alumínio   Ahead   90 mm   7°
	<b>MANOPLA</b>	MTB preta
	<b>CONJUNTO DE FREIO</b>	Disco   Mecânico   X-Time
	<b>DISCO DE FREIO</b>	160 mm   Parafuso   Aço
	<b>ARO/RAIO</b>	TSW MTB  29"   32 furos   Folha dupla aero
	<b>CUBOS</b>	X-Time   Rosca   Alumínio   32 furos   Esfera   Eixo de 9mm
	<b>PNEU / CÂMARA DE AR</b>	<b>Pneu:</b> Arisun Graham   Skinwall   29" x 2.20   <b>Câmara de ar</b> Arisun   Válvula americana
	<b>PEDIVELA</b>	Shimano TY-301   Engrenagem Tripla com braço   170 mm   24/34/42D.
	<b>CORRENTE</b>	KMC   7 Velocidades
	<b>EIXO CENTRAL</b>	34.7 C/ ROL. 122.5mm

	<b>RODA LIVRE</b>	Shimano TZ 500   7 velocidades   14-28D.   Rosca   Index
	<b>CÂMBIO DIANTEIRO</b>	TZ 500   Shimano   TOP PULL   Abraçadeira 31.8mm
	<b>CÂMBIO TRASEIRO</b>	Tourney TY200   Shimano   7 Velocidades   Index
	<b>ALAVANCA / MANETE</b>	Alavanca/Manete de freio   Shimano EF-41   21 Velocidades (3x7v)
	<b>SELIM</b>	TSW MTB   Vazado   Trilho de aço
	<b>CANOTE</b>	X-Time  Alumínio  27.2 x 350 mm   Com carrinho
	<b>ABRAÇADEIRA</b>	X-Time   Alumínio   31.8mm   Blocação
	<b>PEDAL</b>	Plataforma   MTB   Inglês 9/16   Nylon   Preto
	<b>URBANA</b>	✓
	<b>CICLOTURISMO</b>	✓
	<b>TRILHAS INTERMEDIÁRIAS</b>	X
	<b>COMPETIÇÃO</b>	X

## 29" NACIONAL

15.5 ■ 21523

17.5 ■ N/A

19 ■ 21527

# ride

**AQUI TEM**

**SHIMANO**

QUALIDADE CONFIANÇA

















#SEMPRESHIMANO















BICICLETAS



40

	<b>QUADRO</b>	MTB RIDE 29", Alumínio 6061, Cabeamento Interno, Direção mega over semi-integrada Ø 44 x 44 mm, Suporte de freio a disco standard, Caixa central BSA 68 mm, Eixo traseiro 9 x 135mm, Canote 27.2 mm, Largura máxima do pneu 29 x 2.2" com cravo baixo, Peso máximo suportado de 110 kg - PESO DO CICLISTA + ACESSÓRIOS
	<b>SUSPENSÃO DIANTEIRA</b>	29"   TSW   100 mm   Mola   Over head set   (OLD) 9 x 100 mm   Lower leg e garfo de aço
	<b>SUSPENSÃO TRASEIRA</b>	N/A
	<b>MOVIMENTO DE DIREÇÃO</b>	Mega over semi-integrada Ø 44 x 44 mm   Esfera   Caixa de aço
	<b>GUIDÃO</b>	X-Time   Alumínio   Reto   31.8 x 740 mm   9° Backsweep
	<b>SUporte DE GUIDÃO</b>	X-Time   Alumínio   Ahead   90 mm   7°
	<b>MANOPLA</b>	MTB preta
	<b>CONJUNTO DE FREIO</b>	Disco   Mecânico   X-Time
	<b>DISCO DE FREIO</b>	160 mm   Parafuso   Aço
	<b>ARO/RAIO</b>	TSW MTB   29"   32 furos   Folha dupla aero
	<b>CUBOS</b>	X-Time   Rosca   Alumínio   32 furos   Esfera   Eixo de 9mm
	<b>PNEU / CÂMARA DE AR</b>	<b>Pneu:</b> Arisun Graham   Skinwall   29" x 2.20 / <b>Câmara de ar</b> Arisun   Válvula americana
	<b>PEDIVELA</b>	Shimano TY-301   Engrenagem Tripla com braço   170 mm   24/34/42D.
	<b>CORRENTE</b>	KMC   7 Velocidades
	<b>EIXO CENTRAL</b>	34.7 C/ ROL. 122.5mm

	<b>RODA LIVRE</b>	Shimano TZ 500   7 velocidades   14-28D.   Rosca   Index
	<b>CÂMBIO DIANTEIRO</b>	TZ 500   Shimano   TOP PULL   Abraçadeira 31.8mm
	<b>CÂMBIO TRASEIRO</b>	Tourney TY200   Shimano   7 Velocidades   Index
	<b>ALAVANCA / MANETE</b>	Alavanca/Manete de freio   Shimano EF-41   21 Velocidades (3x7v)
	<b>SELIM</b>	TSW MTB   Vazado   Trilho de aço
	<b>CANOTE</b>	X-Time   Alumínio   27.2 x 350 mm   Com carrinho
	<b>ABRAÇADEIRA</b>	X-Time   Alumínio   31.8mm   Blocação
	<b>PEDAL</b>	Plataforma   MTB   Inglês 9/16   Nylon   Preto
	<b>URBANA</b>	✓
	<b>CICLOTURISMO</b>	✓
	<b>TRILHAS INTERMEDIÁRIAS</b>	X
	<b>COMPETIÇÃO</b>	X

29" NACIONAL

15.5	■	21524
17.5	■	N/A
19	■	21528

FOTOS MERAMENTE ILUSTRATIVAS. AS INFORMAÇÕES/CONFIGURAÇÕES DE PRODUTOS PODERÃO SOFRER ALTERAÇÕES SEM AVISO PRÉVIO.



























ENTRE EM CONTATO COM O SEU CONSULTOR OU FALE COM O NOSSO TIME DE TELEVENDAS PELO (33) 3277-3030.





# warship



 <b>QUADRO</b>	Quadro 26" MTB TSW WARSHIP   Alumínio   Cabeamento da marcha interno   Central BSA   Direção Mega over 44 mm   Canote 27.2 mm   Freio a Disco Post Mount   Eixo traseiro 135 mm -	 <b>CASSETE</b>	Shimano HG 200   9 velocidades   11/36 D
 <b>SUSPENSÃO DIANTEIRA</b>	Garfo com suspensão TSW aço   Trava Remota de Alumínio   100 mm de curso	 <b>CÂMBIO DIANTEIRO</b>	N/A
 <b>SUSPENSÃO TRASEIRA</b>	N/A	 <b>CÂMBIO TRASEIRO</b>	Shimano Alívio   9 velocidades   Shimano Shadow RD M3100
 <b>MOVIMENTO DE DIREÇÃO</b>	Mega over   Esferado   Caixa de Aço	 <b>ALAVANCA</b>	Traseira   Shimano Alívio SI3100   9 Velocidades
 <b>GUIDÃO</b>	X-Time   Rise Bar   Alumínio   31.9 x 800 mm   7° backsweep   Upsweep 5°   Rise 15 mm	 <b>SELIM</b>	TSW MTB preto (vazado)   Trilho Aço
 <b>SUPOORTE DE GUIDÃO</b>	X-time   Alumínio   35x45 mm - 0°	 <b>CANOTE</b>	X-Time   27.2 x 400 mm   Carrinho   Alumínio   Microajuste   Slim
 <b>MANOPLA</b>	MTB - TSW light preto	 <b>ABRACADEIRA</b>	Alumínio   34.8 mm   Blocação
 <b>CONJUNTO DE FREIO</b>	X-time Hidráulico   Base Alumínio com Alavanca de Aço	 <b>PEDAL</b>	Inglês 9/16   Alumínio   Preto
 <b>DISCO DE FREIO</b>	Shimano   160 mm   RT-10	 <b>URBANA</b>	✓
 <b>ARO/RAIO</b>	TSW T-5000   26" Aero   Parede Dupla   VZAN   Alumínio   32 Furos   Ilhós   Pneu 1.5" até 2.4"   Válvula Americana   Raio preto (2 mm)	 <b>CICLOTURISMO</b>	x
 <b>CUBOS</b>	Shimano TX505   8/9/10 Velocidades   Cassete   Eixo 9 mm	 <b>TRILHAS INTERMEDIÁRIAS</b>	x
 <b>PNEU / CÂMARA DE AR</b>	<b>Pneu:</b> Arisun Graham 26x2.00" <b>Câmara:</b> 26" Chaoyang   Válvula Americana	 <b>COMPETIÇÃO</b>	x
 <b>PEDIVELA</b>	X-Time Ponta Quadrada   Single   32D   Alumínio	 <b>PESO APROXIMADO</b>	13.7 kg
 <b>CORRENTE</b>	KMC Série Z   9 velocidades		
 <b>EIXO CENTRAL</b>	34.7 x 115 mm   Quadrado   Aço   Rolamentos		

26" NACIONAL

16537

# warship



	<b>QUADRO</b>	Quadro 26" MTB TSW WARSHIP   Alumínio   Cabeamento da marcha interno   Central BSA   Direção Mega over 44 mm   Canote 27.2 mm   Freio a Disco Post Mount   Eixo traseiro 135 mm -
	<b>SUSPENSÃO DIANTEIRA</b>	Garfo com suspensão TSW aço   Trava Remota de Alumínio   100 mm de curso
	<b>SUSPENSÃO TRASEIRA</b>	N/A
	<b>MOVIMENTO DE DIREÇÃO</b>	Mega over   Esferado   Caixa de Aço
	<b>GUIDÃO</b>	X-Time   Rise Bar   Alumínio   31.9 x 800 mm   7° backsweep   Upsweep 5°   Rise 15 mm
	<b>SUPORTE DE GUIDÃO</b>	X-time   Alumínio   35x45 mm - 0°
	<b>MANOPLA</b>	MTB - TSW light preto
	<b>CONJUNTO DE FREIO</b>	X-time Hidráulico   Base Alumínio com Alavanca de Aço
	<b>DISCO DE FREIO</b>	Shimano   160 mm   RT-10
	<b>ARO/RAIO</b>	TSW T-5000   26" Aero   Parede Dupla   VZAN   Alumínio   32 Furos   Ilhós   Pneu 1.5" até 2.4"   Válvula Americana   Raio preto (2 mm)
	<b>CUBOS</b>	Shimano TX505   8/9/10 Velocidades   Cassete   Eixo 9 mm
	<b>PNEU / CÂMARA DE AR</b>	<b>Pneu:</b> Arisun Graham 26x2.00" <b>Câmara:</b> 26" Chaoyang   Válvula Americana
	<b>PEDIVELA</b>	X-Time Ponta Quadrada   Single   32D   Alumínio
	<b>CORRENTE</b>	KMC Série Z   9 velocidades
	<b>EIXO CENTRAL</b>	34.7 x 115 mm   Quadrado   Aço   Rolamentos

	<b>CASSETE</b>	Shimano HG 200   9 velocidades   11/36 D
	<b>CÂMBIO DIANTEIRO</b>	N/A
	<b>CÂMBIO TRASEIRO</b>	Shimano Alívio   9 velocidades   Shimano Shadow RD M3100
	<b>ALAVANCA</b>	Traseira   Shimano Alívio SI3100   9 Velocidades
	<b>SELIM</b>	TSW MTB preto (vazado)   Trilho Aço
	<b>CANOTE</b>	X-Time   27.2 x 400 mm   Carrinho   Alumínio   Microajuste   Slim
	<b>ABRAÇADEIRA</b>	Alumínio   34.8 mm   Blocação
	<b>PEDAL</b>	Inglês 9/16   Alumínio   Preto
	<b>URBANA</b>	✓
	<b>CICLOTURISMO</b>	x
	<b>TRILHAS INTERMEDIÁRIAS</b>	x
	<b>COMPETIÇÃO</b>	x
	<b>PESO APROXIMADO</b>	13.7 kg

26" NACIONAL

16538

# warship



 <b>QUADRO</b>	Quadro 26" MTB TSW WARSHIP   Alumínio   Cabeamento da marcha interno   Central BSA   Direção Mega over 44 mm   Canote 27.2 mm   Freio a Disco Post Mount   Eixo traseiro 135 mm -	 <b>CASSETE</b>	Shimano HG 200   9 velocidades   11/36 D
 <b>SUSPENSÃO DIANTEIRA</b>	Garfo com suspensão TSW aço   Trava Remota de Alumínio   100 mm de curso	 <b>CÂMBIO DIANTEIRO</b>	N/A
 <b>SUSPENSÃO TRASEIRA</b>	N/A	 <b>CÂMBIO TRASEIRO</b>	Shimano Alívio   9 velocidades   Shimano Shadow RD M3100
 <b>MOVIMENTO DE DIREÇÃO</b>	Mega over   Esferado   Caixa de Aço	 <b>ALAVANCA</b>	Traseira   Shimano Alívio SI3100   9 Velocidades
 <b>GUIDÃO</b>	X-Time   Rise Bar   Alumínio   31.9 x 800 mm   7° backsweep   Upsweep 5°   Rise 15 mm	 <b>SELIM</b>	TSW MTB preto (vazado)   Trilho Aço
 <b>SUPORE DE GUIDÃO</b>	X-time   Alumínio   35x45 mm - 0°	 <b>CANOTE</b>	X-Time   27.2 x 400 mm   Carrinho   Alumínio   Microajuste   Slim
 <b>MANOPLA</b>	MTB - TSW light preto	 <b>ABRAÇADEIRA</b>	Alumínio   34.8 mm   Blocação
 <b>CONJUNTO DE FREIO</b>	X-time Hidráulico   Base Alumínio com Alavanca de Aço	 <b>PEDAL</b>	Inglês 9/16   Alumínio   Preto
 <b>DISCO DE FREIO</b>	Shimano   160 mm   RT-10	 <b>URBANA</b>	✓
 <b>ARO/RAIO</b>	TSW T-5000   26" Aero   Parede Dupla   VZAN   Alumínio   32 Furos   Ilhós   Pneu 1.5" até 2.4"   Válvula Americana   Raio preto (2 mm)	 <b>CICLOTURISMO</b>	x
 <b>CUBOS</b>	Shimano TX505   8/9/10 Velocidades   Cassete   Eixo 9 mm	 <b>TRILHAS INTERMEDIÁRIAS</b>	x
 <b>PNEU / CÂMARA DE AR</b>	<b>Pneu:</b> Arisun Graham 26x2.00" <b>Câmara:</b> 26" Chaoyang   Válvula Americana	 <b>COMPETIÇÃO</b>	x
 <b>PEDIVELA</b>	X-Time Ponta Quadrada   Single   32D   Alumínio	 <b>PESO APROXIMADO</b>	13.7 kg
 <b>CORRENTE</b>	KMC Série Z   9 velocidades		
 <b>EIXO CENTRAL</b>	34.7 x 115 mm   Quadrado   Aço   Rolamentos		

































26" NACIONAL

■ 17198

# ride

21 velocidades  
V.Brake







	<b>QUADRO</b>	Aro 26"   TSW   Alumínio   Direção Mega Over de 44 mm   Central BSA 68 mm   Canote 27.2 mm   Freio: Disco Standard(IS) e V-Brake		<b>EIXO CENTRAL</b>	Movimento Central 34.7mm   68x122.5mm   Semi Selado   Ponta quadrada								
	<b>GARFO</b>	Garfo suspensão TSW   Aro 26"   Freio: Disco Standard(IS) e V-Brake   Eixo 9 x 100 mm		<b>RODA LIVRE</b>	Roda Livre Bronze 7V.   14/28D.   Index Xtime ou Shimano								
	<b>SUSPENSÃO TRASEIRA</b>	N/A		<b>CÂMBIO DIANTEIRO</b>	Shimano TZ500   Top pull								
	<b>MOVIMENTO DE DIREÇÃO</b>	Mega Over		<b>CÂMBIO TRASEIRO</b>	Shimano 7Velocidades   TZ31								
	<b>GUIDÃO</b>	31.8 x 730 mm   Alumínio   Rise bar (baixo)   ou   31.8 x 740 mm   9° backsweep   Alumínio   Reto   X-Time (envio de acordo com a disponibilidade do estoque)		<b>MANETE/ALAVANCA</b>	Alavanca X-TIME EZ- Fire 21V. (3x7)   Com manete de freio								
	<b>SUPORTE DE GUIDÃO</b>	X-Time   31.8 x 90 mm/+ - 7°		<b>SELIM</b>	TSW   Com castanha								
	<b>MANOPLA</b>	Manopla MTB   Borracha		<b>CANOTE</b>	Para castanha   27.2 x 350 mm   Aço								
	<b>CONJUNTO DE FREIO</b>	V-Brake   Alumínio		<b>ABRAÇADEIRA</b>	Abraçadeira 31.8mm   Alumínio   Blocação								
	<b>DISCO DE FREIO</b>	N/A		<b>PEDAL</b>	Plataforma   Preto   Nylon   Inglês								
	<b>ARO/RAIO</b>	<b>Aro:</b> TSW 4300   Alumínio 6063   36 Furos   Parede dupla / <b>Raio:</b> Preto   Aço   250 x 2.0 mm		<b>URBANA</b>	✓								
	<b>CUBOS</b>	<b>Dianteiro:</b> Aço   36 furos   Esferado   Eixo de 9 x 100 mm   Com blocação - <b>Traseiro:</b> Aço   36 furos   Esferado   Rosca (Roda livre)   9 x 135 mm   Com Blocação		<b>CICLOTURISMO</b>	X								
	<b>PNEU / CÂMARA DE AR</b>	<b>Pneu:</b> Arisun   Skinwall <b>Câmara:</b> 26"   Válvula americana		<b>TRILHAS INTERMEDIÁRIAS</b>	X								
	<b>PEDIVELA</b>	Engrenagem Tripla (42/34/24D)   braço 165 mm		<b>COMPETIÇÃO</b>	X								
	<b>CORRENTE</b>	6/7/8v.   Index corrida   TEC   ou   6/7v.   112L   Index corrida   PYC (envio de acordo com a disponibilidade do estoque)	<div style="display: flex; justify-content: space-around;"> <div style="border: 1px solid black; padding: 2px;">COLIGADA 01</div> <div style="border: 1px solid black; padding: 2px;">COLIGADA 06</div> </div> <p>26" NACIONAL</p> <table style="width: 100%; border-collapse: collapse;"> <tbody> <tr> <td style="width: 10%; text-align: center;">15.5</td> <td style="width: 10%; text-align: center;"></td> <td style="width: 30%; text-align: center;">17203  </td> <td style="width: 30%; text-align: center;">20559</td> </tr> <tr> <td style="text-align: center;">17</td> <td style="text-align: center;"></td> <td style="text-align: center;">17206  </td> <td style="text-align: center;">20562</td> </tr> </tbody> </table>			15.5		17203	20559	17		17206	20562
15.5		17203	20559										
17		17206	20562										

# ride

21 velocidades  
V.Brake



 <b>QUADRO</b>	Aro 26"   TSW   Alumínio   Direção Mega Over de 44 mm   Central BSA 68 mm   Canote 27.2 mm   Freio: Disco Standard(IS) e V-Brake	 <b>EIXO CENTRAL</b>	Movimento Central 34.7mm   68x122.5mm   Semi Selado   Ponta quadrada
 <b>GARFO</b>	Garfo suspensão TSW   Aro 26"   Freio: Disco Standard(IS) e V-Brake   Eixo 9 x 100 mm	 <b>RODA LIVRE</b>	Roda Livre Bronze 7V.   14/28D.   Index Xtime ou Shimano
 <b>SUSPENSÃO TRASEIRA</b>	N/A	 <b>CÂMBIO DIANTEIRO</b>	Shimano TZ500   Top pull
 <b>MOVIMENTO DE DIREÇÃO</b>	Mega Over	 <b>CÂMBIO TRASEIRO</b>	Shimano 7Velocidades   TZ31
 <b>GUIDÃO</b>	31.8 x 730 mm   Alumínio   Rise bar (baixo)   ou   31.8 x 740 mm   9° backsweep   Alumínio   Reto   X-Time (envio de acordo com a disponibilidade do estoque)	 <b>MANETE/ALAVANCA</b>	Alavanca X-TIME EZ- Fire 21V. (3x7)   Com manete de freio
 <b>SUPORTE DE GUIDÃO</b>	X-Time   31.8 x 90 mm/+ - 7°	 <b>SELIM</b>	TSW   Com castanha
 <b>MANOPLA</b>	Manopla MTB   Borracha	 <b>CANOTE</b>	Para castanha   27.2 x 350 mm   Aço
 <b>CONJUNTO DE FREIO</b>	V-Brake   Alumínio	 <b>ABRAÇADEIRA</b>	Abraçadeira 31.8mm   Alumínio   Blocagem
 <b>DISCO DE FREIO</b>	N/A	 <b>PEDAL</b>	Plataforma   Preto   Nylon   Inglês
 <b>ARO/RAIO</b>	<b>Aro:</b> TSW 4300   Alumínio 6063   36 Furos   Parede dupla / <b>Raio:</b> Preto   Aço   250 x 2.0 mm	 <b>URBANA</b>	✓
 <b>CUBOS</b>	<b>Dianteiro:</b> Aço   36 furos   Esferado   Eixo de 9 x 100 mm   Com blocagem - <b>Traseiro:</b> Aço   36 furos   Esferado   Rosca (Roda livre)   9 x 135 mm   Com Blocagem	 <b>CICLOTURISMO</b>	X
 <b>PNEU / CÂMARA DE AR</b>	<b>Pneu:</b> Arisun   Skinwall <b>Câmara:</b> 26"   Válvula americana	 <b>TRILHAS INTERMEDIÁRIAS</b>	X
 <b>PEDIVELA</b>	Engrenagem Tripla (42/34/24D)   braço 165 mm	 <b>COMPETIÇÃO</b>	X
 <b>CORRENTE</b>	6/7/8v.   Index corrida   TEC   ou   6/7v.   112L   Index corrida   PYC (envio de acordo com a disponibilidade do estoque)		

COLIGADA 01

COLIGADA 06

26" NACIONAL

15.5 ■ 17204 | 20560

17 ■ 17207 | 20563

# ride

21 velocidades  
V.Brake



	<b>QUADRO</b>	Aro 26"   TSW   Alumínio   Direção Mega Over de 44 mm   Central BSA 68 mm   Canote 27.2 mm   Freio: Disco Standard(IS) e V-Brake
	<b>GARFO</b>	Garfo suspensão TSW   Aro 26"   Freio: Disco Standard(IS) e V-Brake   Eixo 9 x 100 mm
	<b>SUSPENSÃO TRASEIRA</b>	N/A
	<b>MOVIMENTO DE DIREÇÃO</b>	Mega Over
	<b>GUIDÃO</b>	31.8 x 730 mm   Alumínio   Rise bar (baixo)   ou   31.8 x 740 mm   9° backsweep   Alumínio   Reto   X-Time (envio de acordo com a disponibilidade do estoque)
	<b>SUPORTE DE GUIDÃO</b>	X-Time   31.8 x 90 mm/+ - 7°
	<b>MANOPLA</b>	Manopla MTB   Borracha
	<b>CONJUNTO DE FREIO</b>	V-Brake   Alumínio
	<b>DISCO DE FREIO</b>	N/A
	<b>ARO/RAIO</b>	<b>Aro:</b> TSW 4300   Alumínio 6063   36 Furos   Parede dupla / <b>Raio:</b> Preto   Aço   250 x 2.0 mm
	<b>CUBOS</b>	<b>Dianteiro:</b> Aço   36 furos   Esferado   Eixo de 9 x 100 mm   Com blocagem - <b>Traseiro:</b> Aço   36 furos   Esferado   Rosca (Roda livre)   9 x 135 mm   Com Blocagem
	<b>PNEU / CÂMARA DE AR</b>	<b>Pneu:</b> Arisun   Skinwall <b>Câmara:</b> 26"   Válvula americana
	<b>PEDIVELA</b>	Engrenagem Tripla (42/34/24D)   braço 165 mm
	<b>CORRENTE</b>	6/7/8v.   Index corrida   TEC   ou   6/7v.   112L   Index corrida   PYC (envio de acordo com a disponibilidade do estoque)

	<b>EIXO CENTRAL</b>	Movimento Central 34.7mm   68x122.5mm   Semi Selado   Ponta quadrada
	<b>RODA LIVRE</b>	Roda Livre Bronze 7V.   14/28D.   Index Xtime ou Shimano
	<b>CÂMBIO DIANTEIRO</b>	Shimano TZ500   Top pull
	<b>CÂMBIO TRASEIRO</b>	Shimano 7Velocidades   TZ31
	<b>MANETE/ALAVANCA</b>	Alavanca X-TIME EZ- Fire 21V. (3x7)   Com manete de freio
	<b>SELIM</b>	TSW   Com castanha
	<b>CANOTE</b>	Para castanha   27.2 x 350 mm   Aço
	<b>ABRAÇADEIRA</b>	Abraçadeira 31.8mm   Alumínio   Blocagem
	<b>PEDAL</b>	Plataforma   Preto   Nylon   Inglês
	<b>URBANA</b>	✓
	<b>CICLOTURISMO</b>	X
	<b>TRILHAS INTERMEDIÁRIAS</b>	X
	<b>COMPETIÇÃO</b>	X

COLIGADA 01

COLIGADA 06

26" NACIONAL

15.5 N/A | 20561

17 17208 | 20565

FOTOS MERAMENTE ILUSTRATIVAS. AS INFORMAÇÕES/CONFIGURAÇÕES DE PRODUTOS PODERÃO SOFRER ALTERAÇÕES SEM AVISO PRÉVIO.

ENTRE EM CONTATO COM O SEU CONSULTOR OU FALE COM O NOSSO TIME DE TELEVENDAS PELO (33) 3277-3030.

# Tcross



20"  
WHEELS

	<b>QUADRO</b>	TSW T Cross   Aro 20"   Aço   Caixa over Ahead Set   Seat Tube 22.5 mm   Suporte Freio V-Brake   Cabeamento Externo
	<b>GARFO</b>	Rígido   Aço   Aro 20"   Espiga Over headset
	<b>SUSPENSÃO TRASEIRA</b>	N/A
	<b>MOVIMENTO DE DIREÇÃO</b>	Over Ahead Set   Esfera
	<b>GUIDÃO</b>	Medida 700 x 21.0 mm   Aço   Bmx
	<b>SUPORTE DE GUIDÃO</b>	Alumínio   Diâmetro 22.4 mm   Comprimento 40 mm
	<b>MANOPLA</b>	Borracha
	<b>CONJUNTO DE FREIO</b>	Traseiro   V-Brake   Aço/Sapata com Parafuso   Preto   Manete Nylon/Alumínio
	<b>DISCO DE FREIO</b>	N/A
	<b>ARO/RAIO</b>	Aro 20"   Alumínio   Folha Única   Somente para V-Brake / Raio Aço 2 mm Preto
	<b>CUBOS</b>	Dianteiro: Aço   36 furos   Sem Blocagem   Somente para V-Brake / Traseiro: Aço   36 furos   Sem Blocagem   Somente para V-Brake   Rosca

	<b>PNEU / CÂMARA DE AR</b>	Pneu: Aro 20 X 2.1" / Câmara: 20 x 1.95"   Válvula americana
	<b>PEDIVELA</b>	Braço de Aço 145 mm   Engrenagem Single   28 Dentes
	<b>CORRENTE</b>	Single
	<b>MOVIMENTO CENTRAL</b>	Monobloco   Esferado
	<b>RODA LIVRE</b>	Single   16 Dentes   Importado
	<b>CÂMBIO DIANTEIRO</b>	N/A
	<b>CÂMBIO TRASEIRO</b>	N/A
	<b>ALAVANCA</b>	N/A
	<b>SELIM</b>	Cross   castanha
	<b>CANOTE</b>	Aço   Medida 22.5 x 250 mm   Sem carrinho
	<b>ABRAÇADEIRA</b>	No quadro   Parafuso
	<b>PEDAL</b>	Plataforma   Preto   Nylon

20" IMPORTADA

ÚNICO ■ 17410

# Tcross



20"  
WHEELS

 <b>QUADRO</b>	TSW T Cross   Aro 20"   Aço   Caixa over Ahead Set   Seat Tube 22.5 mm   Suporte Freio V-Brake   Cabeamento Externo
 <b>GARFO</b>	Rígido   Aço   Aro 20"   Espiga Over headset
 <b>SUSPENSÃO TRASEIRA</b>	N/A
 <b>MOVIMENTO DE DIREÇÃO</b>	Over Ahead Set   Esfera
 <b>GUIDÃO</b>	Medida 700 x 21.0 mm   Aço   Bmx
 <b>SUporte DE GUIDÃO</b>	Alumínio   Diâmetro 22.4 mm   Comprimento 40 mm
 <b>MANOPLA</b>	Borracha
 <b>CONJUNTO DE FREIO</b>	Traseiro   V-Brake   Aço/Sapata com Parafuso   Preto   Manete Nylon/Aluminio
 <b>DISCO DE FREIO</b>	N/A
 <b>ARO/RAIO</b>	Aro 20"   Alumínio   Folha Única   Somente para V-Brake / Raio Aço 2 mm Preto
 <b>CUBOS</b>	Dianteiro: Aço   36 furos   Sem Blocação   Somente para V-Brake / Traseiro: Aço   36 furos   Sem Blocação   Somente para V-Brake   Rosca
 <b>PNEU / CÂMARA DE AR</b>	Pneu: Aro 20 X 2.1" / Câmara: 20 x 1.95"   Válvula americana
 <b>PEDIVELA</b>	Braço de Aço 145 mm   Engrenagem Single   28 Dentes
 <b>CORRENTE</b>	Single

 <b>MOVIMENTO CENTRAL</b>	Monobloco   Esferado
 <b>RODA LIVRE</b>	Single   16 Dentes   Importado
 <b>CÂMBIO DIANTEIRO</b>	N/A
 <b>CÂMBIO TRASEIRO</b>	N/A
 <b>ALAVANCA</b>	N/A
 <b>SELIM</b>	Cross   castanha
 <b>CANOTE</b>	Aço   Medida 22.5 x 250 mm   Sem carrinho
 <b>ABRAÇADEIRA</b>	No quadro   Parafuso
 <b>PEDAL</b>	Plataforma   Preto   Nylon

20" | IMPORTADA

ÚNICO  17411



# TCROSS

BICICLETAS



16"  
WHEELS

 <b>QUADRO</b>	TSW T Cross   Aro 16"   Aço   Caixa over Head Set esferada   Suporte Freio V-Brake   Cabeamento Externo
 <b>GARFO</b>	TSW T-Cross aro 16" Aço   Over Head Set
 <b>SUSPENSÃO TRASEIRA</b>	N/A
 <b>MOVIMENTO DE DIREÇÃO</b>	Caixa de direção Over Head Set esferada
 <b>GUIDÃO</b>	Guidão Cross 22.2 mm   Aço   Possui acessório de Guidão TSW
 <b>SUporte DE GUIDÃO</b>	Alumínio   Over Head Set
 <b>MANOPLA</b>	Nylon
 <b>CONJUNTO DE FREIO</b>	Freio V-Brake de aço   Manete tipo MTB de nylon com reguladores
 <b>DISCO DE FREIO</b>	N/A
 <b>ARO/RAIO</b>	Aro 16"   Alumínio   Folha simples   Preto   Raios zincados
 <b>CUBOS</b>	Cubos em aço   Eixo de 9mm   Com Porca sextavada
 <b>PNEU / CÂMARA DE AR</b>	Pneu: Aro 16 X 2.125" / Câmara: aro 16" Válvula americana
 <b>PEDIVELA</b>	Monobloco   Preto   115 mm Coroa Aço 24D
 <b>CORRENTE</b>	Comum importada   Porta corrente de Nylon
 <b>MOVIMENTO CENTRAL</b>	Movimento central 50 mm esferado

 <b>RODA LIVRE</b>	16 Dentes
 <b>CÂMBIO DIANTEIRO</b>	N/A
 <b>CÂMBIO TRASEIRO</b>	N/A
 <b>ALAVANCA</b>	N/A
 <b>SELIM</b>	Infantil   Preto   Com castanha
 <b>CANOTE</b>	Aço   Medida 25.4 mm
 <b>ABRACADEIRA</b>	No quadro   Parafuso
 <b>PEDAL</b>	Infantil   Nylon 1/2 suco   Preto

16" | IMPORTADA

ÚNICO ■ 17406

FOTOS MERAMENTE ILUSTRATIVAS. AS INFORMAÇÕES/CONFIGURAÇÕES DE PRODUTOS PODERÃO SOFRER ALTERAÇÕES SEM AVISO PRÉVIO.

ENTRE EM CONTATO COM O SEU CONSULTOR OU FALE COM O NOSSO TIME DE TELEVENDAS PELO (33) 3277-3030.

# T-CROSS



16"  
WHEELS

	<b>QUADRO</b>	TSW T Cross   Aro 16"   Aço   Caixa over Head Set esferada   Suporte Freio V-Brake   Cabeamento Externo
	<b>GARFO</b>	TSW T-Cross aro 16" Aço   Over Head Set
	<b>SUSPENSÃO TRASEIRA</b>	N/A
	<b>MOVIMENTO DE DIREÇÃO</b>	Caixa de direção Over Head Set esferada
	<b>GUIDÃO</b>	Guidão Cross 22.2 mm   Aço   Possui acessório de Guidão TSW
	<b>SUporte DE GUIDÃO</b>	Alumínio   Over Head Set
	<b>MANOPLA</b>	Nylon
	<b>CONJUNTO DE FREIO</b>	Freio V-Brake de aço   Manete tipo MTB de nylon com reguladores
	<b>DISCO DE FREIO</b>	N/A
	<b>ARO/RAIO</b>	Aro 16"   Alumínio   Folha simples   Preto   Raios zincados
	<b>CUBOS</b>	Cubos em aço   Eixo de 9mm   Com Porca sextavada
	<b>PNEU / CÂMARA DE AR</b>	Pneu: Aro 16 X 2.125" / Câmara: aro 16" Válvula americana
	<b>PEDIVELA</b>	Monobloco   Preto   115 mm Coroa Aço 24D
	<b>CORRENTE</b>	Comum importada   Porta corrente de Nylon
	<b>MOVIMENTO CENTRAL</b>	Movimento central 50 mm esferado

	<b>RODA LIVRE</b>	16 Dentes
	<b>CÂMBIO DIANTEIRO</b>	N/A
	<b>CÂMBIO TRASEIRO</b>	N/A
	<b>ALAVANCA</b>	N/A
	<b>SELIM</b>	Infantil   Preto   Com castanha
	<b>CANOTE</b>	Aço   Medida 25.4 mm
	<b>ABRAÇADEIRA</b>	No quadro   Parafuso
	<b>PEDAL</b>	Infantil   Nylon 1/2 sueco   Preto

16" IMPORTADA

ÚNICO ■ 17407

# MOTION

12"  
WHEELS



 **QUADRO** TSW Motion | Balance | Aro 12" | Alumínio 6061

 **GARFO** TSW | Rígido | Aro 12" | Alumínio

 **CAIXA DE DIREÇÃO** Mega Over | Head Set | Semi-Integrado | Esferado

 **GUIDÃO** TSW | Alumínio | Reto | 25.4 x 400 mm

 **SUPORTE DE GUIDÃO** TSW | Alumínio | 60 mm/7°

 **MANOPLA** Borracha

 **CONJUNTO DE FREIO** Tambor | Maçaneta de Nylon

 **ARO/RAIO** Aro: Aço | 12" / Raio: Preto | 2.0 mm

 **CUBOS** Aço com esfera | Eixo de 9 mm

 **PNEU / CÂMARA DE AR** Pneu SLIN | 12 x 2.25" / Câmara com válvula americana

 **CANOTE** Aço | 22 mm | Selim integrado

 **ABRAÇADEIRA** Alumínio | Blocação



## IMPORTADA

12"  17397

12"  17398

12"  17399

12"  17401

12"  17400

FOTOS MERAMENTE ILUSTRATIVAS. AS INFORMAÇÕES/CONFIGURAÇÕES DE PRODUTOS PODERÃO SOFRER ALTERAÇÕES SEM AVISO PRÉVIO.

ENTRE EM CONTATO COM O SEU CONSULTOR OU FALE COM O NOSSO TIME DE TELEVENDAS PELO (33) 3277-3030.

# TSW Posh



16"  
WHEELS



16"  
WHEELS

	<b>QUADRO</b>	TSW Posh   Aro 16"   Aço   Porta corrente de aço inteiriço   Roda lateral reforçada e emborrachada   Paralama de aço com haste   Cestinha retrô nylon   Suporte traseiro de nylon (Cadeirinha para bonecas)   Sinalizador sonoro
	<b>GARFO</b>	Aço   Aro 16"
	<b>SUSPENSÃO TRASEIRA</b>	N/A
	<b>MOVIMENTO DE DIREÇÃO</b>	Standard   Rosca   Esferas
	<b>GUIDÃO</b>	Curvo   25.4 mm   Aço
	<b>SUporte DE GUIDÃO</b>	Alumínio   Chanfrado
	<b>MANOPLA</b>	Borracha
	<b>CONJUNTO DE FREIO</b>	V-Brake   Aço <b>Manete:</b> Infantil   Nylon com reguladores
	<b>DISCO DE FREIO</b>	N/A
	<b>ARO/RAIO</b>	<b>Aro:</b> 16"   Aço   Folha simples <b>Raio:</b> Aço   Preto
	<b>CUBOS</b>	Aço   Eixo 9 mm   Porca sextavada

	<b>PNEU / CÂMARA DE AR</b>	<b>Pneu:</b> Aro 16"   2.1125   Importado <b>Câmara:</b> Aro 16"   Válvula americana
	<b>PEDIVELA</b>	Monobloco   115 mm   Preto   Coroa aço   32 D
	<b>CORRENTE</b>	Comum   Importada
	<b>MOVIMENTO CENTRAL</b>	45 mm   Esferado
	<b>RODA LIVRE</b>	16 Dentes
	<b>CÂMBIO DIANTEIRO</b>	N/A
	<b>CÂMBIO TRASEIRO</b>	N/A
	<b>ALAVANCA</b>	N/A
	<b>SELIM</b>	Infantil   Castanha   Branco
	<b>CANOTE</b>	Aço   25.4 mm
	<b>ABRAÇADEIRA</b>	N/A
	<b>PEDAL</b>	Nylon   Infantil   1/2 sueco   Branco

16" IMPORTADA SEM CÂMBIO

ÚNICO 18204

ÚNICO 18205

# TSW Posh



20"  
WHEELS



20"  
WHEELS

	<b>QUADRO</b>	TSW Rerô   Aro 20"   Aço   Cesta   Seat tube 22.2mm   Caixa standard   Suporte para freio v-brake   Porta corrente   Descanso lateral
	<b>GARFO</b>	Rígido   Aço   Aro 20"   Espiga standard   Rosca   Suporte para freio v-brake
	<b>SUSPENSÃO TRASEIRA</b>	N/A
	<b>MOVIMENTO DE DIREÇÃO</b>	Standard   Rosca
	<b>GUIDÃO</b>	Passo   Tropical   Cromado   22.1 mm/500 mm
	<b>SUPORTE DE GUIDÃO</b>	Caneta   Alumínio   Standard   Espander
	<b>MANOPLA</b>	Borracha
	<b>CONJUNTO DE FREIO</b>	V-Brake   Aço   Sapata   Manete infantil   Nylon
	<b>DISCO DE FREIO</b>	N/A
	<b>ARO/RAIO</b>	<b>Aro:</b> 20"   Alumínio   Folha Única   36 furos <b>Raio:</b> Aço 2 mm Preto
	<b>CUBOS</b>	<b>Dianteiro:</b> Aço   36 furos   Somente para V-Brake   Esferado <b>Traseiro:</b> Aço   36 furos   Sem blocagem   Somente para V-Brake   Rosca



**PNEU / CÂMARA DE AR**

**Pneu:** Aro 20" | 2.10" **Câmara:** Aro 20 | 1.95" | Válvula americana



**PEDIVELA**

Monobloco | 140 mm / rosca fina | Aço



**CORRENTE**

Single



**MOVIMENTO CENTRAL**

Monobloco | Esferado



**RODA LIVRE**

Single | 16 dentes | Importado



**CÂMBIO DIANTEIRO**

N/A



**CÂMBIO TRASEIRO**

N/A



**ALAVANCA**

N/A



**SELIM**

Infantil | Castanha



**CANOTE**

Aço | 22.5 mm/250 mm | Cromado



**ABRACADEIRA**

Blocagem



**PEDAL**

Nylon | Infantil | Rosca fina

20" IMPORTADA

ÚNICO  18209

ÚNICO  18210

# TSW retrô

16"  
WHEELS



QUADRO

**Quadro:** TSW Retrô | Aço | Aro 16"  
| **Bagageiro:** Aço retrô acolchoado |  
**Cestinha:** Nylon retrô | **Paralamas:** Aço  
pintados com haste | **Campanhia:** Nylon/  
aço | **Porta corrente:** Aço inteiriço ( cobre  
toda a parte externa da transmissão) |  
**Roda lateral:** Estilo retrô com suporte em  
aço



GARFO

Aço P/ V-Brake com rosca



SUSPENSÃO  
TRASEIRA

N/A



MOVIMENTO DE  
DIREÇÃO

Esferada Standard



GUIDÃO

Aço cromado chifre de boi | 25.4 mm x  
520 mm



SUPORTE DE  
GUIDÃO

Chanfreado | Alumínio



MANOPLA

Nylon retrô



CONJUNTO DE  
FREIO

V-Brake | Aço | Preto | **Manete:** Nylon com  
reguladores



DISCO DE FREIO

N/A



ARO/RAIO

**Aro:** 16" | Alumínio | Preto | 28 furos tipo  
aero | Folha simples | **Raio:** Aço preto  
2.00 mm X 135 mm



CUBOS

Aço Preto | 28 furos | Eixo maciço com  
porca



PNEU / CÂMARA  
DE AR

**Pneu:** Aro 16" - 16 x 2.125 | Importado



PEDIVELA

Monobloco | 115mm | Aço | Preto



CORRENTE

Bronze SLC | Importado



MOVIMENTO  
CENTRAL

Esferada 45 mm



RODA LIVRE

Bronze 16 dentes | Importado



CÂMBIO  
DIANTEIRO

N/A



CÂMBIO  
TRASEIRO

N/A



ALAVANCA

N/A



SELIM

Retrô | Castanha



CANOTE

Aço zincado | 25.4 mm x 200 mm



ABRAÇADEIRA

N/A



PEDAL

Nylon retrô 1/2

16" | IMPORTADA

ÚNICO  18206

ÚNICO  18207

ÚNICO  18208

# TSW retrô

20"  
WHEELS



20"  
WHEELS



20"  
WHEELS



QUADRO

TSW aço Retrô | Aro 20" | Aço | Bagageiro Aço retrô acolchoado | Cestinha nylon retrô | Descanso lateral de aço | Paralamas pintados c/ haste | Campanhia nylon/ aço | Porta corrente aço inteiriço ( cobre toda a parte externa da transmissão)



GARFO

Aço P/ V-Brake com rosca



SUSPENSÃO TRASEIRA

N/A



MOVIMENTO DE DIREÇÃO

Esferada standard



GUIDÃO

Aço cromado chifre de boi | 25.4 mm x 520 mm



SUPORTE DE GUIDÃO

Chanfreado | Alumínio



MANOPLA

Nylon retrô



CONJUNTO DE FREIO

V-Brake | Aço | Manetes nylon com reguladores



DISCO DE FREIO

N/A



ARO/RAIO

Aro 20" | Alumínio preto | Folha simples | 28 furos tipo aero | Raio aço preto 2.00 mm X 180 mm



CUBOS

Aço preto | 28 furos | Eixo maciço com porca



PNEU / CÂMARA DE AR

**Pneu:** Aro 20" - 20x2.125



PEDIVELA

Monobloco | 140mm | Aço preto



CORRENTE

Bronze SLC



MOVIMENTO CENTRAL

Esferada 45mm



RODA LIVRE

Bronze 16 dentes | Importado



CÂMBIO DIANTEIRO

N/A



CÂMBIO TRASEIRO

N/A



ALAVANCA

N/A



SELIM

Retrô | Castanha



CANOTE

Aço zincado | 25.4 mm x 250 mm



ABRAÇADEIRA

Blocagem



PEDAL

Nylon retrô

## 20" | IMPORTADA

ÚNICO  18211

ÚNICO  18212

ÚNICO  18213















FOTOS MERAMENTE ILUSTRATIVAS. AS INFORMAÇÕES/CONFIGURAÇÕES DE PRODUTOS PODERÃO SOFRER ALTERAÇÕES SEM AVISO PRÉVIO.















ENTRE EM CONTATO COM O SEU CONSULTOR OU FALE COM O NOSSO TIME DE TELEVENDAS PELO (33) 3277-3030.

# U.bend



20"  
WHEELS

	<b>QUADRO</b>	Aro 20"   Alumínio   Dobrável   Trava de segurança na articulação   Lugar para Suporte de Caramanholas   Pivotes para adaptação de Garupas   Caixa de Direção Mega Over   Freio a Disco   Descanso lateral   Urbano
	<b>GARFO</b>	Rígido   Aço   Aro 20"   Espiga Over Rosca   Freio a Disco
	<b>SUSPENSÃO TRASEIRA</b>	N/A
	<b>MOVIMENTO DE DIREÇÃO</b>	Mega Over   Caixa semi-integrada   Esfera
	<b>GUIDÃO</b>	Alumínio   Formato em T   Tubo 28.6 mm com guia
	<b>SUPORTE DE GUIDÃO</b>	Alumínio   Trava de Segurança na articulação   Abraçadeira de Alumínio para Regulagem da altura do Guidão   Tubo 25,4 mm chanfrado
	<b>MANOPLA</b>	Borracha
	<b>CONJUNTO DE FREIO</b>	Disco   Mecânico   Alumínio   Manete com abraçadeira de nylon e alavanca de alumínio
	<b>DISCO DE FREIO</b>	Aço   160 mm   6 parafusos
	<b>ARO/RAIO</b>	Aro 20"   Alumínio   Parede dupla   Com CNC / Raio preto   Aço   2.0 mm
	<b>CUBOS</b>	Dianteiro: Alumínio   Esferado   Blocagem   Freio a disco / Traseiro: Alumínio   Esferado   Blocagem   Freio a disco   Rosca
	<b>PNEU / CÂMARA DE AR</b>	Pneu: Aro 20"   20 x 1.75"   Chaoyang / Câmara: Chaoyang   Válvula americana
	<b>PEDIVELA</b>	Engrenagem coroa única de 46 dentes   Aço   Braço de aço 165 mm   Guia de corrente em nylon na coroa
	<b>CORRENTE</b>	7 velocidades   Index

	<b>MOVIMENTO CENTRAL</b>	34.7 mm   Rolamentado   Eixo ponta quadrada
	<b>RODA LIVRE</b>	Shimano   7 velocidades   Index   MF-TZ500/7
	<b>CÂMBIO DIANTEIRO</b>	N/A
	<b>CÂMBIO TRASEIRO</b>	Shimano   7 velocidades   Index   RD-TY200
	<b>ALAVANCA</b>	Shimano   Revoshift 7 velocidades   Modelo SL-RS35
	<b>SELIM</b>	MTB com castanha
	<b>CANOTE</b>	Alumínio   31.6 x 500 mm   Sem carrinho
	<b>ABRAÇADEIRA</b>	Alumínio   Com blocagem
	<b>PEDAL</b>	Plataforma   Preto   Nylon
	<b>URBANA</b>	✓
	<b>CICLOTURISMO</b>	X
	<b>TRILHAS INTERMEDIÁRIAS</b>	X
	<b>COMPETIÇÃO</b>	X
	<b>PESO APROXIMADO</b>	12.51 kg

20" | IMPORTADA















ÚNICO  18069



# U.bend



20"  
WHEELS

	<b>QUADRO</b>	Aro 20"   Alumínio   Dobrável   Trava de segurança na articulação   Lugar para Suporte de Caramanholas   Pivores para adaptação de Garupas   Caixa de Direção Mega Over   Freio a Disco   Descanso lateral   Urbano
	<b>GARFO</b>	Rígido   Aço   Aro 20"   Espiga Over Rosca   Freio a Disco
	<b>SUSPENSÃO TRASEIRA</b>	N/A
	<b>MOVIMENTO DE DIREÇÃO</b>	Mega Over   Caixa semi-integrada   Esfera
	<b>GUIDÃO</b>	Alumínio   Formato em T   Tubo 28.6 mm com guia
	<b>SUPORTE DE GUIDÃO</b>	Alumínio   Trava de Segurança na articulação   Abraçadeira de Alumínio para Regulagem da altura do Guidão   Tubo 25,4 mm chanfrado
	<b>MANOPLA</b>	Borracha
	<b>CONJUNTO DE FREIO</b>	Disco   Mecânico   Alumínio   Manete com abraçadeira de nylon e alavanca de alumínio
	<b>DISCO DE FREIO</b>	Aço   160 mm   6 parafusos
	<b>ARO/RAIO</b>	Aro 20"   Alumínio   Parede dupla   Com CNC / Raio preto   Aço   2.0 mm
	<b>CUBOS</b>	Dianteiro: Alumínio   Esferado   Blocagem   Freio a disco / Traseiro: Alumínio   Esferado   Blocagem   Freio a disco   Rosca
	<b>PNEU / CÂMARA DE AR</b>	Pneu: Aro 20"   20 x 1.75"   Chaoyang / Câmara: Chaoyang   Válvula americana
	<b>PEDIVELA</b>	Engrenagem coroa única de 46 dentes   Aço   Braço de aço 165 mm   Guia de corrente em nylon na coroa
	<b>CORRENTE</b>	7 velocidades   Index

	<b>MOVIMENTO CENTRAL</b>	34.7 mm   Rolamentado   Eixo ponta quadrada
	<b>RODA LIVRE</b>	Shimano   7 velocidades   Index   MF-TZ500/7
	<b>CÂMBIO DIANTEIRO</b>	N/A
	<b>CÂMBIO TRASEIRO</b>	Shimano   7 velocidades   Index   RD-TY200
	<b>ALAVANCA</b>	Shimano   Revoshift 7 velocidades   Modelo SL-RS35
	<b>SELIM</b>	MTB com castanha
	<b>CANOTE</b>	Alumínio   31.6 x 500 mm   Sem carrinho
	<b>ABRAÇADEIRA</b>	Alumínio   Com blocagem
	<b>PEDAL</b>	Plataforma   Preto   Nylon
	<b>URBANA</b>	✓
	<b>CICLOTURISMO</b>	X
	<b>TRILHAS INTERMEDIÁRIAS</b>	X
	<b>COMPETIÇÃO</b>	X
	<b>PESO APROXIMADO</b>	12.51 kg

20" | IMPORTADA

ÚNICO ■ 18070

AVENIDA INDUSTRIAL 312, DISTRITO INDUSTRIAL  
GOVERNADOR VALADARES - MINAS GERAIS/BRASIL

BIKE@GRUPOJPP.COM.BR

(33) 3277-3030

WWW.GRUPOJPP.COM.BR



GRUPO

JPP



CATÁLOGO

B I C I C L E T A S

06 de Março 2024



# rakban SR-DR

12V. Hidráulico



29"  
WHEELS

Urbana

Alumínio

Mega Over

12 velocidades

Disco Hidráulico

Kg -



QUADRO

Quadro Rava MTB Rakan 29" | Caixa Central BSA 68 x 34.7mm | Suporte de Freio Post Mount dentro do triângulo traseiro | Eixo traseiro 135 mm x 9 mm | Largura do pneu 2.20 (com cravos baixos) | Alumínio 6061 | Cabeamento interno | Direção Mega Over semi-integrada caixa 44 mm | Tubo do canote 27.2 mm | Peso máximo suportado 120 Kg (ciclista + acessórios).



SUSPENSÃO DIANTEIRA

Suspensão Suntour XCM30 | Eixo de 9 mm | Ahead set | Trava Remota | OLD 100mm | Kraw e Lower Leg de alumínio



SUSPENSÃO TRASEIRA

N/A



MOVIMENTO DE DIREÇÃO

Direção mega over | Semi-integrada | Esferada



GUIDÃO

X-Time | Alumínio | Reto | 31.8 x 740 mm | 9° backsweep



SUPOORTE DE GUIDÃO

X-Time | Ahead | Alumínio | 31.8 x 70 mm | +/-17°



MANOPLA

MTB | Preta | Light



CONJUNTO DE FREIO

X-Time | Hidráulico | Abraçadeira | Reservatório de alumínio | Óleo mineral | Caliper 2 pistões



DISCO DE FREIO

X-Time | 160 mm | 06 parafusos | Aço



ARO/RAIO

Rava | Alumínio 6063 | 622x23mm | ERD 600 mm | Parede dupla | 32F | Raio preto | PSI máximo 80/40 | Tubeless Ready | Compatível com pneu 1.5" até 2.4"



CUBOS

Cubo X-Time | Rolamentado | Alumínio | Blocação | Freehub standard | 32 furos



PNEU / CÂMARA DE AR

**Pneu:** Arisun Skinwall Mount Bona 29x2.10 **Câmara:** Arisun 29" | Válvula Presta



PEDIVELA

X-Time integrado | Single | Coroa 30D. (Bicicletas 15.5" e 17") e coroa 32D. (Bicicleta 19") | Coroa Alumínio Direct | Off Set 3mm | Braço Alumínio 170mm



CORRENTE

Corrente 12S | SRAM | Power Link



MOVIMENTO CENTRAL

X-Time integrado | Rolamentos | Alumínio



CASSETE

SRAM SX | Index | 12v | Standard | 11/50D. (11/13/15/17/19/22/25/28/32/36/42/50T)



CÂMBIO DIANTEIRO

N/A



CÂMBIO TRASEIRO

Shimano Deore RD-M6100 | 12v



ALAVANCA

Shimano Deore SL-M6100 | 12v | Traseira



SELIM

Rava MTB | Trilho de aço | Vazado



CANOTE

X-Time | Alumínio | 27.2 x 350 mm | Carrinho | Parafuso único



ABRAÇADEIRA

X-Time | Alumínio | 31.8 | Blocação



PEDAL

Inglês 9/16 | Preto | Alumínio



URBANA

✓



CICLOTURISMO

✓



TRILHAS INTERMEDIÁRIAS

X



COMPETIÇÃO

X

29" NACIONAL

15.5 ■ 21465

17 ■ N/A

19 ■ N/A

FOTOS MERAMENTE ILUSTRATIVAS. AS INFORMAÇÕES/CONFIGURAÇÕES DE PRODUTOS PODERÃO SOFRER ALTERAÇÕES SEM AVISO PRÉVIO.

ENTRE EM CONTATO COM O SEU CONSULTOR OU FALE COM O NOSSO TIME DE TELEVENDAS PELO (33) 3277-3030.

RAVA

3

# rakan SR-DR

12V. Hidráulico



29"  
WHEELS



Urbana



Alumínio



Mega Over



12 velocidades



Disco Hidráulico



Kg



QUADRO

Quadro Rava MTB Rakan 29" | Caixa Central BSA 68 x 34.7mm | Suporte de Freio Post Mount dentro do triângulo traseiro | Eixo traseiro 135 mm x 9 mm | Largura do pneu 2.20 (com cravos baixos) | Alumínio 6061 | Cabeamento interno | Direção Mega Over semi-integrada caixa 44 mm | Tubo do canote 27.2 mm | Peso máximo suportado 120 Kg (ciclista + acessórios).



SUSPENSÃO DIANTEIRA

Suspensão Suntour XCM30 | Eixo de 9 mm | Ahead set | Trava Remota | OLD 100mm | Kraw e Lower Leg de alumínio



SUSPENSÃO TRASEIRA

N/A



MOVIMENTO DE DIREÇÃO

Direção mega over | Semi-integrada | Esferada



GUIDÃO

X-Time | Alumínio | Reto | 31.8 x 740 mm | 9° backsweep



SUPPORTO DE GUIDÃO

X-Time | Ahead | Alumínio | 31.8 x 70 mm | +/-17°



MANOPLA

MTB | Preta | Light



CONJUNTO DE FREIO

X-Time | Hidráulico | Abraçadeira | Reservatório de alumínio | Óleo mineral | Caliper 2 pistões



DISCO DE FREIO

X-Time | 160 mm | 06 parafusos | Aço



ARO/RAIO

Rava | Alumínio 6063 | 622x23mm | ERD 600 mm | Parede dupla | 32F | Raio preto | PSI máximo 80/40 | Tubeless Ready | Compatível com pneu 1.5" até 2.4"



CUBOS

Cubo X-Time | Rolamentado | Alumínio | Blocagem | Freehub standard | 32 furos



PNEU / CÂMARA DE AR

**Pneu:** Arisun Skinwall Mount Bona 29x2.10 **Câmara:** Arisun 29" | Válvula Presta



PEDIVELA

X-Time integrado | Single | Coroa 30D. (Bicicletas 15.5" e 17") e coroa 32D. (Bicicleta 19") | Coroa Alumínio Direct | Off Set 3mm | Braço Alumínio 170mm



CORRENTE

Corrente 12S | SRAM | Power Link



MOVIMENTO CENTRAL

X-Time integrado | Rolamentos | Alumínio



CASSETE

SRAM SX | Index | 12v | Standard | 11/50D. (11/13/15/17/19/22/25/28/32/36/42/50T)



CÂMBIO DIANTEIRO

N/A



CÂMBIO TRASEIRO

Shimano Deore RD-M6100 | 12v



ALAVANCA

Shimano Deore SL-M6100 | 12v | Traseira



SELIM

Rava MTB | Trilho de aço | Vazado



CANOTE

X-Time | Alumínio | 27.2 x 350 mm | Carrinho | Parafuso único



ABRAÇADEIRA

X-Time | Alumínio | 31.8 | Blocagem



PEDAL

Inglês 9/16 | Preto | Alumínio



URBANA

✓



CICLOTURISMO

✓



TRILHAS INTERMEDIÁRIAS

×



COMPETIÇÃO

×

29" NACIONAL

15.5  21464

17  N/A

19  N/A

FOTOS MERAMENTE ILUSTRATIVAS. AS INFORMAÇÕES/CONFIGURAÇÕES DE PRODUTOS PODERÃO SOFRER ALTERAÇÕES SEM AVISO PRÉVIO.

ENTRE EM CONTATO COM O SEU CONSULTOR OU FALE COM O NOSSO TIME DE TELEVENDAS PELO (33) 3277-3030.

# rakan

12V. Hidráulico



29"  
WHEELS



Urbana



Alumínio



Mega Over



12 velocidades



Disco Hidráulico



14.74



QUADRO

Quadro Rava MTB Rakan 29" | Caixa Central BSA 68 x 34.7mm | Suporte de Freio Post Mount dentro do triângulo traseiro | Eixo traseiro 135 mm x 9 mm | Largura do pneu 2.20 (com cravos baixos) | Alumínio 6061 | Cabeamento interno | Direção Mega Over semi-integrada caixa 44 mm | Tubo do canote 27.2 mm | Peso máximo suportado 120 Kg (ciclista + acessórios).



SUSPENSÃO DIANTEIRA

Suspensão Suntour XCM30 | Eixo de 9 mm | Ahead set | Trava Remota | OLD 100 mm | Kraw e Lower Leg de alumínio



SUSPENSÃO TRASEIRA

N/A



MOVIMENTO DE DIREÇÃO

Direção Mega Over | Semi-integrada | Esferada



GUIDÃO

X-Time | Alumínio | Reto | 31.8 x 740 mm | 9° Backsweep



SUPOORTE DE GUIDÃO

X-Time | Ahead | Alumínio | 31.8 x 70 mm | +/-17°



MANOPLA

MTB | Preta | Light



CONJUNTO DE FREIO

X-Time | Hidráulico | Abraçadeira | Reservatório de alumínio | Óleo mineral | Caliper 2 pistões



DISCO DE FREIO

X-Time | 160 mm | 06 parafusos | Aço



ARO/RAIO

Rava | Alumínio 6063 | 622 x 23 mm | ERD 600 mm | Parede dupla | 32F | Raio preto | PSI máximo 80/40 | Tubeless Ready | Compatível com pneu 1.5" até 2.4"



CUBOS

Cubo X-Time | Rolamentado | Alumínio | Blocação | Freehub standard | 32 furos



PNEU / CÂMARA DE AR

**Pneu:** Arisun Skinwall Mount Bona 29x2.10 **Câmara:** Arisun 29" | Válvula Presta



PEDIVELA

X-Time integrado | Single | Coroa 32D Alumínio Direct | Off Set 3 mm | Braço Alumínio 170 mm



CORRENTE

Corrente 12S | SUMC | Missing link / Power Link



MOVIMENTO CENTRAL

X-Time integrado | Rolamentos | Alumínio



CASSETE

X-TIME | Index | 12 velocidades | Aranha dos Cogs superiores de alumínio | 11/52D (11-13-15-18-21-23-26-30-34-40-46-52)



CÂMBIO DIANTEIRO

N/A



CÂMBIO TRASEIRO

XTIME 12V. | Roldanas 12D. | Corpo em Alumínio | Cage de Aço | Guia do Cabo de Nylon | Tecnologia U-Pulley (onde um dente é maior que o outro para melhor encaixe na corrente)



ALAVANCA

XTIME 12V. | Alumínio/ Plástico



SELIM

Rava MTB | Trilho de aço | Vazado



CANOTE

X-Time | Alumínio | 27.2 x 350 mm | Carrinho | Parafuso único



ABRAÇADEIRA

X-Time | Alumínio | 31.8 | Blocação



PEDAL

Inglês 9/16 | Preto | Alumínio



URBANA

✓



CICLOTURISMO

✓

29" NACIONAL

15.5  19972

17  N/A

19  N/A

RAVA

5

FOTOS MERAMENTE ILUSTRATIVAS. AS INFORMAÇÕES/CONFIGURAÇÕES DE PRODUTOS PODERÃO SOFRER ALTERAÇÕES SEM AVISO PRÉVIO.

ENTRE EM CONTATO COM O SEU CONSULTOR OU FALE COM O NOSSO TIME DE TELEVENDAS PELO (33) 3277-3030.

# rakran

12V. Hidráulico



29"  
WHEELS

Urbana

Alumínio

Mega Over

12 velocidades

Disco Hidráulico

Kg 14.74



QUADRO

Quadro Rava MTB Rakan 29" | Caixa Central BSA 68 x 34.7mm | Suporte de Freio Post Mount dentro do triângulo traseiro | Eixo traseiro 135 mm x 9 mm | Largura do pneu 2.20 (com cravos baixos) | Alumínio 6061 | Cabeamento interno | Direção Mega Over semi-integrada caixa 44 mm | Tubo do canote 27.2 mm | Peso máximo suportado 120 Kg (ciclista + acessórios).



SUSPENSÃO DIANTEIRA

Suspensão Suntour XCM30 | Eixo de 9 mm | Ahead set | Trava Remota | OLD 100 mm | Kraw e Lower Leg de alumínio



SUSPENSÃO TRASEIRA

N/A



MOVIMENTO DE DIREÇÃO

Direção Mega Over | Semi-integrada | Esferada



GUIDÃO

X-Time | Alumínio | Reto | 31.8 x 740 mm | 9° Backsweep



SUPORTE DE GUIDÃO

X-Time | Ahead | Alumínio | 31.8 x 70 mm | +/-17°



MANOPLA

MTB | Preta | Light



CONJUNTO DE FREIO

X-Time | Hidráulico | Abraçadeira | Reservatório de alumínio | Óleo mineral | Caliper 2 pistões



DISCO DE FREIO

X-Time | 160 mm | 06 parafusos | Aço



ARO/RAIO

Rava | Alumínio 6063 | 622 x 23 mm | ERD 600 mm | Parede dupla | 32F | Raio preto | PSI máximo 80/40 | Tubeless Ready | Compatível com pneu 1.5" até 2.4"



CUBOS

Cubo X-Time | Rolamentado | Alumínio | Blocação | Freehub standard | 32 furos



PNEU / CÂMARA DE AR

**Pneu:** Arisun Skinwall Mount Bona 29x2.10 **Câmara:** Arisun 29" | Válvula Presta



PEDIVELA

X-Time integrado | Single | Coroa 32D Alumínio Direct | Off Set 3 mm | Braço Alumínio 170 mm



CORRENTE

Corrente 12S | SUMC | Missing link / Power Link



MOVIMENTO CENTRAL

X-Time integrado | Rolamentos | Alumínio



CASSETE

X-TIME | Index | 12 velocidades | Aranha dos Cogs superiores de alumínio | 11/52D (11-13-15-18-21-23-26-30-34-40-46-52)



CÂMBIO DIANTEIRO

N/A



CÂMBIO TRASEIRO

XTIME 12V. | Roldanas 12D. | Corpo em Alumínio | Cage de Aço | Guia do Cabo de Nylon | Tecnologia U-Pulley (onde um dente é maior que o outro para melhor encaixe na corrente)



ALAVANCA

XTIME 12V. | Alumínio/ Plástico



SELIM

Rava MTB | Trilho de aço | Vazado



CANOTE

X-Time | Alumínio | 27.2 x 350 mm | Carrinho | Parafuso único



ABRAÇADEIRA

X-Time | Alumínio | 31.8 | Blocação



PEDAL

Inglês 9/16 | Preto | Alumínio



URBANA

✓



CICLOTURISMO

✓

29" NACIONAL

15.5 ■ 19973

17 ■ N/A

19 ■ N/A

FOTOS MERAMENTE ILUSTRATIVAS. AS INFORMAÇÕES/CONFIGURAÇÕES DE PRODUTOS PODERÃO SOFRER ALTERAÇÕES SEM AVISO PRÉVIO.

ENTRE EM CONTATO COM O SEU CONSULTOR OU FALE COM O NOSSO TIME DE TELEVENDAS PELO (33) 3277-3030.





# KIT pressure 12v

COLIGADA 6



29"  
WHEELS

 Urbana











 Alumínio

 Mega Over

 12 velocidades

 Disco Hidráulico

	<b>QUADRO</b>	Quadro Rava MTB Pressure 29"   Caixa central BSA 68 mm   Suporte de Freio Standard   Eixo traseiro 135 mm x 9 mm   Largura do pneu 2.20 (com cravos baixos)   Alumínio 6061   Cabeamento da marcha interno   Direção Mega Over semi-integrada caixa 44 mm   Tubo do canote 27.2 mm   Blocação de rodas, canote e selim.
	<b>SUSPENSÃO DIANTEIRA</b>	Suspensão TSW   Eixo de 9 mm   Ahead set   Trava Remota   OLD 100mm   Kraw alumínio   Lower Leg de aço
	<b>SUSPENSÃO TRASEIRA</b>	N/A
	<b>MOVIMENTO DE DIREÇÃO</b>	Direção Mega Over   Semi-integrada   Esferada
	<b>GUIDÃO</b>	X-Time   Alumínio   Reto   31.8 x 740 mm   9° backsweep
	<b>SUPORTE DE GUIDÃO</b>	X-Time   Ahead   Alumínio   31.8 x 90 mm   +/-7°
	<b>MANOPLA</b>	MTB   Preta
	<b>CONJUNTO DE FREIO</b>	X-Time   Hidráulico   Abraçadeira   Reservatório de alumínio   Óleo mineral   Caliper 2 pistões
	<b>DISCO DE FREIO</b>	X-Time   160 mm   06 parafusos   Aço
	<b>ARO/RAIO</b>	Rava   Alumínio 6063   622x19mm   ERD 584 mm   Parede dupla   32F   Raio preto
	<b>CUBOS</b>	Cubo X-Time   Rolamentado   Alumínio   Blocação   Freehub standard   32 furos
	<b>PNEU / CÂMARA DE AR</b>	<b>Pneu:</b> Arisun Skinwall Mount Bona 29x2.10 <b>Câmara:</b> Arisun 29"   Válvula americana

	<b>PEDIVELA</b>	X-Time Ponta Quadrada   Single   Coroa 32D Aço   Braço Alumínio   BCD 104mm
	<b>CORRENTE</b>	Corrente 12S   SUMC/xtime   Missing link / Power Link
	<b>MOVIMENTO CENTRAL</b>	34.7 x 110 mm   Ponta Quadrada   Aço   Rolamentos
	<b>CASSETE</b>	X-TIME   Index   12 velocidades   Aranha dos Cogs superiores de alumínio   11/52D. (11-13-15-18-21-23-26-30-34-40-46-52)
	<b>CÂMBIO DIANTEIRO</b>	N/A
	<b>CÂMBIO TRASEIRO</b>	XTIME 12V   Roldanas 12D.   Corpo em Alumínio   Cage de Aço   Guia do Caço de Nylon   Tecnologia U-Pulley (onde um dente é maior que o outro para melhor encaixe na corrente)
	<b>ALAVANCA</b>	XTIME 12V.   Alumínio/ Plástico
	<b>SELIM</b>	Rava MTB   Trilho de aço   Vazado
	<b>CANOTE</b>	X-Time   Alumínio   27.2 x 350 mm   Carrinho   Parafuso único
	<b>ABRAÇADEIRA</b>	X-Time   Alumínio   31.8   Blocação
	<b>PEDAL</b>	Inglês   Preto   Nylon
	<b>URBANA</b>	✓

29" | IMPORTADA

15.5 ■ 20477  
17 ■ 20478  
19 ■ 20479

FOTOS MERAMENTE ILUSTRATIVAS. AS INFORMAÇÕES/CONFIGURAÇÕES DE PRODUTOS PODERÃO SOFRER ALTERAÇÕES SEM AVISO PRÉVIO.

ENTRE EM CONTATO COM O SEU CONSULTOR OU FALE COM O NOSSO TIME DE TELEVENDAS PELO (33) 3277-3030.



# pressure

## CABEAMENTO INTERNO

Edição 20v. Hidráulico



Urbana

Alumínio

Mega Over

20 velocidades

Disco Hidráulico

Kg 13.7

	<b>QUADRO</b>	Rava Pressure 29"   Alumínio 6061   Cabeamento Interno   Direção Mega Over   Freio a disco standard   M. Central BSA 34.7 mm / Tubo 68 mm   Eixo traseiro de 135 x 9 mm   Blocagem de rodas, canote e selim.
	<b>SUSPENSÃO DIANTEIRA</b>	Rava   Aço   80 mm   Eixo de 9 mm   Freio a disco Standard
	<b>SUSPENSÃO TRASEIRA</b>	N/A
	<b>MOVIMENTO DE DIREÇÃO</b>	Mega Over   Semi-integrada com esferas
	<b>GUIDÃO</b>	X-Time   Alumínio   Reto   31.8 x 740 mm   9° backsweep
	<b>SUPORTE DE GUIDÃO</b>	X-Time   Ahead   Alumínio   31.8 x 90 mm/7°
	<b>MANOPLA</b>	MTB   Borracha
	<b>CONJUNTO DE FREIO</b>	X-Time   Disco   Hidráulico   Dianteiro/Traseiro   manete de aço
	<b>DISCO DE FREIO</b>	Dianteiro/Traseiro   160 mm   Parafuso
	<b>ARO/RAIO</b>	Aro 29 x 32f alumínio mtb preto rava mod. 02 (By vzan ou by fly – de acordo com o estoque)   Folha dupla tipo aero
	<b>CUBOS</b>	Alumínio   Dianteiro/Traseiro X-time   Blocagem   Freehub standard para 8/9/10v.   32 furos
	<b>PNEU / CÂMARA DE AR</b>	<b>Pneu:</b> Arisun Skinwall 29x2.20   <b>Câmara:</b> Arisun 29"   Válvula americana
	<b>PEDIVELA</b>	X-Time   Engrenagem dupla   36-22 D.   170 mm
	<b>CORRENTE</b>	Corrida   Tec   10v.

	<b>EIXO CENTRAL</b>	Eixo centro 34.7 C/ rol. 115mm   selado com rolamento   Ponta quadrada
	<b>CASSETTE</b>	Cassete 10v. Xtime, index 11-36d.   Estrutura em aço, padrão standard   Escalonamento 11-13-15-17-19-21-24-28-32-36d.
	<b>CÂMBIO DIANTEIRO</b>	X-Time 20v.
	<b>CÂMBIO TRASEIRO</b>	X-Time 10v.
	<b>ALAVANCA</b>	Dianteira/Traseira   X-Time 2 x 10v.   Index
	<b>SELIM</b>	Rava MTB   Mod. 2 RV
	<b>CANOTE</b>	X-Time   Alumínio   27.2 x 350 mm
	<b>ABRAÇADEIRA</b>	X-Time   Alumínio   31.8   C/ Blocagem
	<b>PEDAL</b>	Inglês   Preto   Nylon   Inglês
	<b>URBANA</b>	✓

### 29" NACIONAL

15'5	■	N/A
17	■	19966
19	■	19969

FOTOS MERAMENTE ILUSTRATIVAS. AS INFORMAÇÕES/CONFIGURAÇÕES DE PRODUTOS PODERÃO SOFRER ALTERAÇÕES SEM AVISO PRÉVIO.

ENTRE EM CONTATO COM O SEU CONSULTOR OU FALE COM O NOSSO TIME DE TELEVENDAS PELO (33) 3277-3030.

# pressure

## CABEAMENTO INTERNO

Edição 20v. Hidráulico



Urbana

Alumínio

Mega Over

20 velocidades

Disco Hidráulico

Kg 13.7



### QUADRO

Rava Pressure 29" | Alumínio 6061 | Cabeamento Interno | Direção Mega Over | Freio a disco standard | M. Central BSA 34.7 mm / Tubo 68 mm | Eixo traseiro de 135 x 9 mm | Blocação de rodas, canote e selim.



### SUSPENSÃO DIANTEIRA

Rava | Aço | 80 mm | Eixo de 9 mm | Freio a disco Standard



### SUSPENSÃO TRASEIRA

N/A



### MOVIMENTO DE DIREÇÃO

Mega Over | Semi-integrada com esferas



### GUIDÃO

X-Time | Alumínio | Reto | 31.8 x 740 mm | 9° backsweep



### SUPOORTE DE GUIDÃO

X-Time | Ahead | Alumínio | 31.8 x 90 mm/7°



### MANOPLA

MTB | Borracha



### CONJUNTO DE FREIO

X-Time | Disco | Hidráulico | Dianteiro/Traseiro | manete de aço



### DISCO DE FREIO

Dianteiro/Traseiro | 160 mm | Parafuso



### ARO/RAIO

Aro 29 x 32f alumínio mtb preto rava mod. 02 (By vzan ou by fly – de acordo com o estoque) | Folha dupla tipo aero



### CUBOS

Alumínio | Dianteiro/Traseiro X-time | Blocação | Freehub standard para 8/9/10v. | 32 furos



### PNEU / CÂMARA DE AR

**Pneu:** Arisun Skinwall 29x2.20 | **Câmara:** Arisun 29" | Válvula americana



### PEDIVELA

X-Time | Engrenagem dupla | 36-22 D. | 170 mm



### CORRENTE

Corrida | Tec | 10v.



### EIXO CENTRAL

Eixo centro 34.7 C/ rol. 115mm | selado com rolamento | Ponta quadrada



### CASSETE

Cassete 10v. Xtime, index 11-36d. | Estrutura em aço, padrão standard | Escalonamento 11-13-15-17-19-21-24-28-32-36d.



### CÂMBIO DIANTEIRO

X-Time 20v.



### CÂMBIO TRASEIRO

X-Time 10v.



### ALAVANCA

Dianteira/Traseira | X-Time 2 x 10v. | Index



### SELIM

Rava MTB | Mod. 2 RV



### CANOTE

X-Time | Alumínio | 27.2 x 350 mm



### ABRAÇADEIRA

X-Time | Alumínio | 31.8 | C/ Blocação



### PEDAL

Inglês | Preto | Nylon | Inglês



### URBANA

✓

### 29" NACIONAL

15'5 19964

17 19967

19 19970

# pressure

## CABEAMENTO INTERNO

Edição 20v. Hidráulico



Urbana



Alumínio



Mega Over



























20 velocidades



Disco Hidráulico



13.7

 <b>QUADRO</b>	Rava Pressure 29"   Alumínio 6061   Cabeamento Interno   Direção Mega Over   Freio a disco standard   M. Central BSA 34.7 mm / Tubo 68 mm   Eixo traseiro de 135 x 9 mm   Blocagem de rodas, canote e selim.	 <b>EIXO CENTRAL</b>	Eixo centro 34.7 C/ rol. 115mm   selado com rolamento   Ponta quadrada
 <b>SUSPENSÃO DIANTEIRA</b>	Rava   Aço   80 mm   Eixo de 9 mm   Freio a disco Standard	 <b>CASSETTE</b>	Cassete 10v. Xtime, index 11-36d.   Estrutura em aço, padrão standard   Escalonamento 11-13-15-17-19-21-24-28-32-36d.
 <b>SUSPENSÃO TRASEIRA</b>	N/A	 <b>CÂMBIO DIANTEIRO</b>	X-Time 20v.
 <b>MOVIMENTO DE DIREÇÃO</b>	Mega Over   Semi-integrada com esferas	 <b>CÂMBIO TRASEIRO</b>	X-Time 10v.
 <b>GUIDÃO</b>	X-Time   Alumínio   Reto   31.8 x 740 mm   9° backsweep	 <b>ALAVANCA</b>	Dianteira/Traseira   X-Time 2 x 10v.   Index
 <b>SUPORTE DE GUIDÃO</b>	X-Time   Ahead   Alumínio   31.8 x 90 mm/7°	 <b>SELIM</b>	Rava MTB   Mod. 2 RV
 <b>MANOPLA</b>	MTB   Borracha	 <b>CANOTE</b>	X-Time   Alumínio   27.2 x 350 mm
 <b>CONJUNTO DE FREIO</b>	X-Time   Disco   Hidráulico   Dianteiro/Traseiro   manete de aço	 <b>ABRÇAÇADEIRA</b>	X-Time   Alumínio   31.8   C/ Blocagem
 <b>DISCO DE FREIO</b>	Dianteiro/Traseiro   160 mm   Parafuso	 <b>PEDAL</b>	Inglês   Preto   Nylon   Inglês
 <b>ARO/RAIO</b>	Aro 29 x 32f alumínio mtb preto rava mod. 02 (By vzan ou by fly – de acordo com o estoque)   Folha dupla tipo aero	 <b>URBANA</b>	✓
 <b>CUBOS</b>	Alumínio   Dianteiro/Traseiro X-time   Blocagem   Freehub standard para 8/9/10v.   32 furos	<b>29" NACIONAL</b>	
 <b>PNEU / CÂMARA DE AR</b>	<b>Pneu:</b> Arisun Skinwall 29x2.20   <b>Câmara:</b> Arisun 29"   Válvula americana	15'5	■ 19965
 <b>PEDIVELA</b>	X-Time   Engrenagem dupla   36-22 D.   170 mm	17	■ 19968
 <b>CORRENTE</b>	Corrida   Tec   10v.	19	■ 19971

FOTOS MERAMENTE ILUSTRATIVAS. AS INFORMAÇÕES/CONFIGURAÇÕES DE PRODUTOS PODERÃO SOFRER ALTERAÇÕES SEM AVISO PRÉVIO.

ENTRE EM CONTATO COM O SEU CONSULTOR OU FALE COM O NOSSO TIME DE TELEVENDAS PELO (33) 3277-3030.

# pressure

Edição  
21v. Mecânico



Urbana

Alumínio

Mega Over

21 velocidades

Disco Mecânico

14.57 Kg

	<b>QUADRO</b>	Rava Pressure 29"   Alumínio 6061   Direção Mega Over   Freio a disco standard   M. Central BSA 34.7 mm / Tubo 68 mm   Eixo traseiro de 142 x 9 mm   Adesivo não envernizado   Blocagem de rodas, canote e selim.
	<b>SUSPENSÃO DIANTEIRA</b>	Rava   Aço   80 mm   Eixo de 9 mm
	<b>SUSPENSÃO TRASEIRA</b>	N/A
	<b>MOVIMENTO DE DIREÇÃO</b>	Mega Over   Semi-integrada
	<b>GUIDÃO</b>	31.8 x 730 mm   Alumínio   Rise bar (baixo)   ou   31.8 x 740 mm   9° backsweep   Alumínio   Reto   X-Time (envio de acordo com a disponibilidade do estoque)
	<b>SUPORTE DE GUIDÃO</b>	X-Time   Ahead   Alumínio   31.8 x 90 mm/7°
	<b>MANOPLA</b>	MTB – Nylon
	<b>CONJUNTO DE FREIO</b>	X-Time   Disco   Mecânico   Dianteiro/Traseiro
	<b>DISCO DE FREIO</b>	Parafuso   160 mm   Parafuso
	<b>ARO/RAIO</b>	Rava   Alumínio 6063   622x19mm  ERD 584 mm   Parede dupla   32F   Raio preto
	<b>CUBOS</b>	Alumínio   Blocagem   Esfera   Roda livre
	<b>PNEU / CÂMARA DE AR</b>	<b>Pneu:</b> Arisun Skinwall 29x2.20   <b>Câmara:</b> Arisun 29"   Válvula americana
	<b>PEDIVELA</b>	X-Time   Engrenagem tripla   Braço 170 mm Alumínio   Coroas 42/34/24D   Aço
	<b>CORRENTE</b>	6/7/8v.   Index corrida   TEC   ou   6/7v.   112L   Index corrida   PYC (envio de acordo com a disponibilidade do estoque)

	<b>EIXO CENTRAL</b>	34.7   Com rolamento   122.5 mm   Ponta quadrada
	<b>RODA LIVRE</b>	7 velocidades   14-28D Xtime ou Shimano
	<b>CÂMBIO DIANTEIRO</b>	Dual   Shimano TZ 500
	<b>CÂMBIO TRASEIRO</b>	Shimano TZ 31
	<b>ALAVANCA</b>	Passador de marcha/alavanca do freio Dianteira/Traseira   X-Time 3 x 7v.
	<b>SELIM</b>	Rava MTB   Trilho de aço
	<b>CANOTE</b>	X-Time   Alumínio   27.2 x 350 mm   Carrinho   Parafuso único
	<b>ABRAÇADEIRA</b>	X-Time   Alumínio   31.8   Blocagem
	<b>PEDAL</b>	Inglês   Preto   Nylon
	<b>URBANA</b>	✓
	<b>CICLOTURISMO</b>	X
	<b>TRILHAS INTERMEDIÁRIAS</b>	X

## 29" NACIONAL

15.5 19941

17 19946

FOTOS MERAMENTE ILUSTRATIVAS. AS INFORMAÇÕES/CONFIGURAÇÕES DE PRODUTOS PODERÃO SOFRER ALTERAÇÕES SEM AVISO PRÉVIO.

ENTRE EM CONTATO COM O SEU CONSULTOR OU FALE COM O NOSSO TIME DE TELEVENDAS PELO (33) 3277-3030.

# pressure

 Edição 21v. Mecânico

Canote de acordo com o Estoque



Urbana



Alumínio



Mega Over



21 velocidades



Disco Mecânico



14.57 Kg



QUADRO

Rava Pressure 29" | Alumínio 6061 | Direção Mega Over | Freio a disco standard | M. Central BSA 34.7 mm / Tubo 68 mm | Eixo traseiro de 142 x 9 mm | Adesivo não envernizado | Blocação de rodas, canote e selim.



SUSPENSÃO DIANTEIRA

Rava | Aço | 80 mm | Eixo de 9 mm



SUSPENSÃO TRASEIRA

N/A



MOVIMENTO DE DIREÇÃO

Mega Over | Semi-integrada



GUIDÃO

31.8 x 730 mm | Alumínio | Rise bar (baixo) | ou | 31.8 x 740 mm | 9° backsweep | Alumínio | Reto | X-Time (envio de acordo com a disponibilidade do estoque)



SUPORTE DE GUIDÃO

X-Time | Ahead | Alumínio | 31.8 x 90 mm/7°



MANOPLA

MTB - Nylon



CONJUNTO DE FREIO

X-Time | Disco | Mecânico | Dianteiro/Traseiro



DISCO DE FREIO

Parafuso | 160 mm | Parafuso



ARO/RAIO

Rava | Alumínio 6063 | 622x19mm | ERD 584 mm | Parede dupla | 32F | Raio preto



CUBOS

Alumínio | Blocação | Esfera | Roda livre



PNEU / CÂMARA DE AR

**Pneu:** Arisun Skinwall 29x2.20 | **Câmara:** Arisun 29" | Válvula americana



PEDIVELA

X-Time | Engrenagem tripla | Braço 170 mm Alumínio | Coroas 42/34/24D | Aço



CORRENTE

6/7/8v. | Index corrida | TEC | ou | 6/7v. | 112L | Index corrida | PYC (envio de acordo com a disponibilidade do estoque)



EIXO CENTRAL

34.7 | Com rolamento | 122.5 mm | Ponta quadrada



RODA LIVRE

7 velocidades | 14-28D Xtime ou Shimano



CÂMBIO DIANTEIRO

Dual | Shimano TZ 500



CÂMBIO TRASEIRO

Shimano TZ 31



ALAVANCA

Passador de marcha/alavanca do freio Dianteira/Traseira | X-Time 3 x 7v.



SELIM

Rava MTB | Trilho de aço



CANOTE

X-Time | Alumínio | 27.2 x 350 mm | Carrinho | Parafuso único



ABRAÇADEIRA

X-Time | Alumínio | 31.8 | Blocação



PEDAL

Inglês | Preto | Nylon



URBANA

✓



CICLOTURISMO

X



TRILHAS INTERMEDIÁRIAS

X

29" NACIONAL

15.5 ■ 19942

17 ■ 19947

FOTOS MERAMENTE ILUSTRATIVAS. AS INFORMAÇÕES/CONFIGURAÇÕES DE PRODUTOS PODERÃO SOFRER ALTERAÇÕES SEM AVISO PRÉVIO.

ENTRE EM CONTATO COM O SEU CONSULTOR OU FALE COM O NOSSO TIME DE TELEVENDAS PELO (33) 3277-3030.



# pressure

Edição  
21v. Mecânico



Urbana

Alumínio

Mega Over

21 velocidades

Disco Mecânico

Kg 14.57

	<b>QUADRO</b>	Rava Pressure 29"   Alumínio 6061   Direção Mega Over   Freio a disco standard   M. Central BSA 34.7 mm / Tubo 68 mm   Eixo traseiro de 142 x 9 mm   Adesivo não envernizado   Blocagem de rodas, canote e selim.
	<b>SUSPENSÃO DIANTEIRA</b>	Rava   Aço   80 mm   Eixo de 9 mm
	<b>SUSPENSÃO TRASEIRA</b>	N/A
	<b>MOVIMENTO DE DIREÇÃO</b>	Mega Over   Semi-integrada
	<b>GUIDÃO</b>	31.8 x 730 mm   Alumínio   Rise bar (baixo)   ou   31.8 x 740 mm   9° backsweep   Alumínio   Reto   X-Time (envio de acordo com a disponibilidade do estoque)
	<b>SUPORTE DE GUIDÃO</b>	X-Time   Ahead   Alumínio   31.8 x 90 mm/7°
	<b>MANOPLA</b>	MTB – Nylon
	<b>CONJUNTO DE FREIO</b>	X-Time   Disco   Mecânico   Dianteiro/Traseiro
	<b>DISCO DE FREIO</b>	Parafuso   160 mm   Parafuso
	<b>ARO/RAIO</b>	Rava   Alumínio 6063   622x19mm  ERD 584 mm   Parede dupla   32F   Raio preto
	<b>CUBOS</b>	Alumínio   Blocagem   Esfera   Roda livre
	<b>PNEU / CÂMARA DE AR</b>	<b>Pneu:</b> Arisun Skinwall 29x2.20   <b>Câmara:</b> Arisun 29"   Válvula americana
	<b>PEDIVELA</b>	X-Time   Engrenagem tripla   Braço 170 mm Alumínio   Coroas 42/34/24D   Aço
	<b>CORRENTE</b>	6/7/8v.   Index corrida   TEC   ou   6/7v.   112L   Index corrida   PYC (envio de acordo com a disponibilidade do estoque)

	<b>EIXO CENTRAL</b>	34.7   Com rolamento   122.5 mm   Ponta quadrada
	<b>RODA LIVRE</b>	7 velocidades   14-28D Xtime ou Shimano
	<b>CÂMBIO DIANTEIRO</b>	Dual   Shimano TZ 500
	<b>CÂMBIO TRASEIRO</b>	Shimano TZ 31
	<b>ALAVANCA</b>	Passador de marcha/alavanca do freio Dianteira/Traseira   X-Time 3 x 7v.
	<b>SELIM</b>	Rava MTB   Trilho de aço
	<b>CANOTE</b>	X-Time   Alumínio   27.2 x 350 mm   Carrinho   Parafuso único
	<b>ABRAÇADEIRA</b>	X-Time   Alumínio   31.8   Blocagem
	<b>PEDAL</b>	Inglês   Preto   Nylon
	<b>URBANA</b>	✓
	<b>CICLOTURISMO</b>	X
	<b>TRILHAS INTERMEDIÁRIAS</b>	X

29" NACIONAL

15.5 19943

17 19948

**RAVA**

15

FOTOS MERAMENTE ILUSTRATIVAS. AS INFORMAÇÕES/CONFIGURAÇÕES DE PRODUTOS PODERÃO SOFRER ALTERAÇÕES SEM AVISO PRÉVIO.

ENTRE EM CONTATO COM O SEU CONSULTOR OU FALE COM O NOSSO TIME DE TELEVENDAS PELO (33) 3277-3030.



Canote de acordo com o Estoque

29"

Urbana

Alumínio

Mega Over

21 velocidades

Disco Mecânico

Kg 14.57

	<b>QUADRO</b>	Rava Pressure 29"   Alumínio 6061   Direção Mega Over   Freio a disco standard   M. Central BSA 34.7 mm / Tubo 68 mm   Eixo traseiro de 142 x 9 mm   Adesivo não envernizado   Blocação de rodas, canote e selim.
	<b>SUSPENSÃO DIANTEIRA</b>	Rava   Aço   80 mm   Eixo de 9 mm
	<b>SUSPENSÃO TRASEIRA</b>	N/A
	<b>MOVIMENTO DE DIREÇÃO</b>	Mega Over   Semi-integrada
	<b>GUIDÃO</b>	31.8 x 730 mm   Alumínio   Rise bar (baixo)   ou   31.8 x 740 mm   9° backsweep   Alumínio   Reto   X-Time (envio de acordo com a disponibilidade do estoque)
	<b>SUORTE DE GUIDÃO</b>	X-Time   Ahead   Alumínio   31.8 x 90 mm/7°
	<b>MANOPLA</b>	MTB – Nylon
	<b>CONJUNTO DE FREIO</b>	X-Time   Disco   Mecânico   Dianteiro/ Traseiro
	<b>DISCO DE FREIO</b>	Parafuso   160 mm   Parafuso
	<b>ARO/RAIO</b>	Rava   Alumínio 6063   622x19mm  ERD 584 mm   Parede dupla   32F   Raio preto
	<b>CUBOS</b>	Alumínio   Blocação   Esfera   Roda livre
	<b>PNEU / CÂMARA DE AR</b>	<b>Pneu:</b> Arisun Skinwall 29x2.20   <b>Câmara:</b> Arisun 29"   Válvula americana
	<b>PEDIVELA</b>	X-Time   Engrenagem tripla   Braço 170 mm Alumínio   Coroas 42/34/24D   Aço
	<b>CORRENTE</b>	6/7/8v.   Index corrida   TEC   ou   6/7v.   112L   Index corrida   PYC (envio de acordo com a disponibilidade do estoque)

	<b>EIXO CENTRAL</b>	34.7   Com rolamento   122.5 mm   Ponta quadrada
	<b>RODA LIVRE</b>	7 velocidades   14-28D Xtime ou Shimano
	<b>CÂMBIO DIANTEIRO</b>	Dual   Shimano TZ 500
	<b>CÂMBIO TRASEIRO</b>	Shimano TZ 31
	<b>ALAVANCA</b>	Passador de marcha/alavanca do freio Dianteira/Traseira   X-Time 3 x 7v.
	<b>SELIM</b>	Rava MTB   Trilho de aço
	<b>CANOTE</b>	X-Time   Alumínio   27.2 x 350 mm   Carrinho   Parafuso único
	<b>ABRAÇADEIRA</b>	X-Time   Alumínio   31.8   Blocação
	<b>PEDAL</b>	Inglês   Preto   Nylon
	<b>URBANA</b>	✓
	<b>CICLOTURISMO</b>	X
	<b>TRILHAS INTERMEDIÁRIAS</b>	X

29" NACIONAL

15.5 ■ 19944

17 ■ 19949

FOTOS MERAMENTE ILUSTRATIVAS. AS INFORMAÇÕES/CONFIGURAÇÕES DE PRODUTOS PODERÃO SOFRER ALTERAÇÕES SEM AVISO PRÉVIO.

ENTRE EM CONTATO COM O SEU CONSULTOR OU FALE COM O NOSSO TIME DE TELEVENDAS PELO (33) 3277-3030.

# pressure

Edição  
21v. Mecânico



Urbana

Alumínio

Mega Over

21 velocidades

Disco Mecânico

14.57

	<b>QUADRO</b>	Rava Pressure 29"   Alumínio 6061   Direção Mega Over   Freio a disco standard   M. Central BSA 34.7 mm / Tubo 68 mm   Eixo traseiro de 142 x 9 mm   Adesivo não envernizado   Blocagem de rodas, canote e selim.
	<b>SUSPENSÃO DIANTEIRA</b>	Rava   Aço   80 mm   Eixo de 9 mm
	<b>SUSPENSÃO TRASEIRA</b>	N/A
	<b>MOVIMENTO DE DIREÇÃO</b>	Mega Over   Semi-integrada
	<b>GUIDÃO</b>	31.8 x 730 mm   Alumínio   Rise bar (baixo)   ou   31.8 x 740 mm   9° backsweep   Alumínio   Reto   X-Time (envio de acordo com a disponibilidade do estoque)
	<b>SUPORTE DE GUIDÃO</b>	X-Time   Ahead   Alumínio   31.8 x 90 mm/7°
	<b>MANOPLA</b>	MTB – Nylon
	<b>CONJUNTO DE FREIO</b>	X-Time   Disco   Mecânico   Dianteiro/Traseiro
	<b>DISCO DE FREIO</b>	Parafuso   160 mm   Parafuso
	<b>ARO/RAIO</b>	Rava   Alumínio 6063   622x19mm  ERD 584 mm   Parede dupla   32F   Raio preto
	<b>CUBOS</b>	Alumínio   Blocagem   Esfera   Roda livre
	<b>PNEU / CÂMARA DE AR</b>	<b>Pneu:</b> Arisun Skinwall 29x2.20   <b>Câmara:</b> Arisun 29"   Válvula americana
	<b>PEDIVELA</b>	X-Time   Engrenagem tripla   Braço 170 mm Alumínio   Coroas 42/34/24D   Aço
	<b>CORRENTE</b>	6/7/8v.   Index corrida   TEC   ou   6/7v.   112L   Index corrida   PYC (envio de acordo com a disponibilidade do estoque)

	<b>EIXO CENTRAL</b>	34.7   Com rolamento   122.5 mm   Ponta quadrada
	<b>RODA LIVRE</b>	7 velocidades   14-28D Xtime ou Shimano
	<b>CÂMBIO DIANTEIRO</b>	Dual   Shimano TZ 500
	<b>CÂMBIO TRASEIRO</b>	Shimano TZ 31
	<b>ALAVANCA</b>	Passador de marcha/alavanca do freio Dianteira/Traseira   X-Time 3 x 7v.
	<b>SELIM</b>	Rava MTB   Trilho de aço
	<b>CANOTE</b>	X-Time   Alumínio   27.2 x 350 mm   Carrinho   Parafuso único
	<b>ABRAÇADEIRA</b>	X-Time   Alumínio   31.8   Blocagem
	<b>PEDAL</b>	Inglês   Preto   Nylon
	<b>URBANA</b>	✓
	<b>CICLOTURISMO</b>	X
	<b>TRILHAS INTERMEDIÁRIAS</b>	X

## 29" NACIONAL

15.5	■	19945
17	■	19950
19	■	19953

FOTOS MERAMENTE ILUSTRATIVAS. AS INFORMAÇÕES/CONFIGURAÇÕES DE PRODUTOS PODERÃO SOFRER ALTERAÇÕES SEM AVISO PRÉVIO.

ENTRE EM CONTATO COM O SEU CONSULTOR OU FALE COM O NOSSO TIME DE TELEVENDAS PELO (33) 3277-3030.

# LAND 21 velocidades V.Brake



Urbana

Alumínio

Mega Over

21 velocidades

V.Brake

13.70

QUADRO	Aro 26"   Rava Land   Alumínio   Direção Mega Over de 44 mm   Central BSA 68 mm   Canote 27.2 mm   Freio: Disco Standard(IS) e V-Brake   Blocação de rodas, canote e selim.	EIXO CENTRAL	Movimento Central 34.7mm   68x122.5mm   Semi Selado   Ponta quadrada
GARFO	Garfo suspensão Rava   Aro 26"   Freio: Disco Standard(IS) e V-Brake   Eixo 9 x 100 mm	RODA LIVRE	Roda Livre Bronze 7V.   14/28D.   Index Xtime ou Shimano
SUSPENSÃO TRASEIRA	N/A	CÂMBIO DIANTEIRO	Shimano TZ500   Top pull
MOVIMENTO DE DIREÇÃO	Mega Over	CÂMBIO TRASEIRO	Shimano 7Velocidades   TZ31
GUIDÃO	X-Time   Rise Bar 31.8 mm x 720 mm   Alumínio	MANETE/ALAVANCA	Alavanca X-TIME EZ- Fire 21V. (3x7)   Com manete de freio
SUPORTE DE GUIDÃO	X-Time   31.8 x 90 mm/+ - 7°	SELIM	Rava   Com castanha
MANOPLA	Manopla MTB   Borracha	CANOTE	Para castanha   27.2 x 350 mm   Aço
CONJUNTO DE FREIO	V-Brake   Alumínio	ABRAÇADEIRA	Abraçadeira 31.8mm   Alumínio   Blocação
DISCO DE FREIO	N/A	PEDAL	Plataforma   Preto   Nylon   Inglês
ARO/RAIO	Aro: Rava  Parede dupla   26" 559 x 19 mm   Alumínio 6063   ERD 535 mm   36 furos - Raio: Preto   250 x 2,0 mm   Com Niple preto	URBANA	✓
CUBOS	<b>Dianteiro:</b> Aço   36 furos   Esferado   Eixo de 9 x 100 mm   Com blocação - <b>Traseiro:</b> Aço   36 furos   Esferado   Rosca (Roda livre)   9 x 135 mm   Com Blocação	CICLOTURISMO	X
PNEU / CÂMARA DE AR	<b>Pneu:</b> Arisun   Skinwall <b>Câmara:</b> 26"   Válvula americana	TRILHAS INTERMEDIÁRIAS	X
PEDIVELA	Engrenagem Tripla (42/34/24D)   braço 165 mm		
CORRENTE	Corrente TEC 21V.   Index		

COLIGADA 01

COLIGADA 06

26" NACIONAL

15.5 17209 | 20566

17 17212 | 20569

FOTOS MERAMENTE ILUSTRATIVAS. AS INFORMAÇÕES/CONFIGURAÇÕES DE PRODUTOS PODERÃO SOFRER ALTERAÇÕES SEM AVISO PRÉVIO.

ENTRE EM CONTATO COM O SEU CONSULTOR OU FALE COM O NOSSO TIME DE TELEVENDAS PELO (33) 3277-3030.

# Land

21 velocidades  
V.Brake



Urbana



Alumínio



Mega Over



21 velocidades



V.Brake



13.70



QUADRO

Aro 26" | Rava Land | Alumínio | Direção Mega Over de 44 mm | Central BSA 68 mm | Canote 27.2 mm | Freio: Disco Standard(IS) e V-Brake | Blocação de rodas, canote e selim.



GARFO

Garfo suspensão Rava | Aro 26" | Freio: Disco Standard(IS) e V-Brake | Eixo 9 x 100 mm



SUSPENSÃO TRASEIRA

N/A



MOVIMENTO DE DIREÇÃO

Mega Over



GUIDÃO

X-Time | Rise Bar 31.8 mm x 720 mm | Alumínio



SUPORTE DE GUIDÃO

X-Time | 31.8 x 90 mm/+ - 7°



MANOPLA

Manopla MTB | Borracha



CONJUNTO DE FREIO

V-Brake | Alumínio



DISCO DE FREIO

N/A



ARO/RAIO

Aro: Rava | Parede dupla | 26" 559 x 19 mm | Alumínio 6063 | ERD 535 mm | 36 furos - Raio: Preto | 250 x 2,0 mm | Com Niple preto



CUBOS

**Dianteiro:** Aço | 36 furos | Esferado | Eixo de 9 x 100 mm | Com blocação - **Traseiro:** Aço | 36 furos | Esferado | Rosca (Roda livre) | 9 x 135 mm | Com Blocação



PNEU / CÂMARA DE AR

**Pneu:** Arisun | Skinwall **Câmara:** 26" | Válvula americana



PEDIVELA

Engrenagem Tripla (42/34/24D) | braço 165 mm



CORRENTE

Corrente TEC 21V. | Index



EIXO CENTRAL

Movimento Central 34.7mm | 68x122.5mm | Semi Selado | Ponta quadrada



RODA LIVRE

Roda Livre Bronze 7V. | 14/28D. | Index Xtime ou Shimano



CÂMBIO DIANTEIRO

Shimano TZ500 | Top pull



CÂMBIO TRASEIRO

Shimano 7Velocidades | TZ31



MANETE/ALAVANCA

Alavanca X-TIME EZ- Fire 21V. (3x7) | Com manete de freio



SELIM

Rava | Com castanha



CANOTE

Para castanha | 27.2 x 350 mm | Aço



ABRAÇADEIRA

Abraçadeira 31.8mm | Alumínio | Blocação



PEDAL

Plataforma | Preto | Nylon | Inglês



URBANA

✓



CICLOTURISMO

X



TRILHAS INTERMEDIÁRIAS

X

COLIGADA 01

COLIGADA 06

26" NACIONAL

15.5 ■ 17210 | 20567

17 ■ 17214 | 20570

FOTOS MERAMENTE ILUSTRATIVAS. AS INFORMAÇÕES/CONFIGURAÇÕES DE PRODUTOS PODERÃO SOFRER ALTERAÇÕES SEM AVISO PRÉVIO.

ENTRE EM CONTATO COM O SEU CONSULTOR OU FALE COM O NOSSO TIME DE TELEVENDAS PELO (33) 3277-3030.

RAVA

# LAND 21 velocidades V.Brake



Urbana

Alumínio

Mega Over

21 velocidades

V.Brake

13.70

<b>QUADRO</b>	Aro 26"   Rava Land   Alumínio   Direção Mega Over de 44 mm   Central BSA 68 mm   Canote 27.2 mm   Freio: Disco Standard(IS) e V-Brake   Blocação de rodas, canote e selim.	<b>EIXO CENTRAL</b>	Movimento Central 34.7mm   68x122.5mm   Semi Selado   Ponta quadrada
<b>GARFO</b>	Garfo suspensão Rava   Aro 26"   Freio: Disco Standard(IS) e V-Brake   Eixo 9 x 100 mm	<b>RODA LIVRE</b>	Roda Livre Bronze 7V.   14/28D.   Index Xtime ou Shimano
<b>SUSPENSÃO TRASEIRA</b>	N/A	<b>CÂMBIO DIANTEIRO</b>	Shimano TZ500   Top pull
<b>MOVIMENTO DE DIREÇÃO</b>	Mega Over	<b>CÂMBIO TRASEIRO</b>	Shimano 7Velocidades   TZ31
<b>GUIDÃO</b>	X-Time   Rise Bar 31.8 mm x 720 mm   Alumínio	<b>MANETE/ALAVANCA</b>	Alavanca X-TIME EZ- Fire 21V. (3x7)   Com manete de freio
<b>SUPORTE DE GUIDÃO</b>	X-Time   31.8 x 90 mm/+ - 7°	<b>SELIM</b>	Rava   Com castanha
<b>MANOPLA</b>	Manopla MTB   Borracha	<b>CANOTE</b>	Para castanha   27.2 x 350 mm   Aço
<b>CONJUNTO DE FREIO</b>	V-Brake   Alumínio	<b>ABRAÇADEIRA</b>	Abraçadeira 31.8mm   Alumínio   Blocação
<b>DISCO DE FREIO</b>	N/A	<b>PEDAL</b>	Plataforma   Preto   Nylon   Inglês
<b>ARO/RAIO</b>	Aro: Rava  Parede dupla   26" 559 x 19 mm   Alumínio 6063   ERD 535 mm   36 furos - Raio: Preto   250 x 2,0 mm   Com Niple preto	<b>URBANA</b>	✓
<b>CUBOS</b>	<b>Dianteiro:</b> Aço   36 furos   Esferado   Eixo de 9 x 100 mm   Com blocação - <b>Traseiro:</b> Aço   36 furos   Esferado   Rosca (Roda livre)   9 x 135 mm   Com Blocação	<b>CICLOTURISMO</b>	X
<b>PNEU / CÂMARA DE AR</b>	<b>Pneu:</b> Arisun   Skinwall <b>Câmara:</b> 26"   Válvula americana	<b>TRILHAS INTERMEDIÁRIAS</b>	X
<b>PEDIVELA</b>	Engrenagem Tripla (42/34/24D)   braço 165 mm		
<b>CORRENTE</b>	Corrente TEC 21V.   Index		

COLIGADA 01

COLIGADA 06

26" NACIONAL

15.5 N/A | 20568

17 - | 20571

FOTOS MERAMENTE ILUSTRATIVAS. AS INFORMAÇÕES/CONFIGURAÇÕES DE PRODUTOS PODERÃO SOFRER ALTERAÇÕES SEM AVISO PRÉVIO.

ENTRE EM CONTATO COM O SEU CONSULTOR OU FALE COM O NOSSO TIME DE TELEVENDAS PELO (33) 3277-3030.

# Land

21 velocidades  
Mecânico



Urbana

Alumínio

Mega Over

21 velocidades

Mecânico

Kg 14.56



QUADRO

Aro 29" | Rava Land | Alumínio 6061 | Cabeamento interno | Direção Mega Over de 44 mm esferada | Canote 27.2 | Central BSA 68 mm | Suporte de freio Standard | Eixo traseiro 135 mm x 9 mm | Largura do pneu: 2.20 | Blocação de rodas, canote e selim.



GARFO

Garfo Rava 29" | Suspensão 100 mm aço | Suporte de freio Standard | Espiga over ahead set | Eixo 9 mm | Old 100 mm



SUSPENSÃO TRASEIRA

N/A



MOVIMENTO DE DIREÇÃO

Mega Over semi-integrada 44 mm | Ahead set | Esferada | Caixa de aço | Acabamento de alumínio



GUIDÃO

31.8 x 730 mm | Alumínio | Rise bar (baixo) | ou | 31.8 x 740 mm | 9° backsweep | Alumínio | Reto | X-Time (envio de acordo com a disponibilidade do estoque)



SUPORTE DE GUIDÃO

X-Time | Preto | Alumínio | 31.8 mm x 90 mm | +- 7°



MANOPLA

Manopla MTB | Borracha



CONJUNTO DE FREIO

X-Time | Mecânico | Pinças de alumínio | Manete MTB alumínio EZ-Fire 3x7V | Cabo de aço comum | Conduíte 5 mm teflonado



DISCO DE FREIO

X-Time | 160 mm | 06 parafusos | Aço



ARO/RAIO

**Aro:** Rava 29"x 32F | Alumínio MTB | Preto | Mod.02 (by Vzan ou Fly - conforme estoque) | Folha dupla tipo aero | Freio a disco **Raio:** Preto | Comum



CUBOS

Eixo 9 mm | Blocação de alumínio | Agulha de aço **Dianteiro:** X-Time | Alumínio 32F | Esfera | Preto **Traseiro:** X-Time | Alumínio 32F | Rosca com esfera | Preto



PNEU / CÂMARA DE AR

**Pneu:** 29"x 2.20 | Skinwall Mount Graham Arisun **Câmara:** 29"x1.75/2.35 | Válvula americana Arisun



PEDIVELA

Engrenagem tripla X-Time | Braço de aço revestido com nylon | Preto | Coroa 24/34/42D | Braço 170 mm | Eixo 9/16 - Inglês



CORRENTE

6/7/8v. | Index corrida | TEC | ou | 6/7v. | 112L | Index corrida | PYC (envio de acordo com a disponibilidade do estoque)



EIXO CENTRAL

34.7 mm com rolamento 122.5 mm | Selado com rolamento | Ponta quadrada



RODA LIVRE

X-time | Index | 7V. | 14/28D | Escalonamento 14-16-18-20-22-24-28D | Xtime ou Shimano



CÂMBIO DIANTEIRO

Shimano Tourney TZ500 | Coroas 42/34/24D | Top pull | Aço | Abraçadeira 31.8 mm



CÂMBIO TRASEIRO

Shimano TZ31 | Aço e nylon | 7 velocidades |



MANETE/ALAVANCA

**Alavanca:** X-Time EZ- Fire | 3x7V. | Alumínio e plástico



SELIM

Rava MTB | Preto



CANOTE

X-Time | MTB com carrinho | Alumínio | 27.2 x 350 mm | Preto



ABRAÇADEIRA

X-Time | Alumínio | MTB 31.8mm | Blocação | Preto



PEDAL

Plataforma | Nylon | Inglês 9/16



URBANA

✓

29" NACIONAL

15.5 19933

17.5 19936

RAVA

21

FOTOS MERAMENTE ILUSTRATIVAS. AS INFORMAÇÕES/CONFIGURAÇÕES DE PRODUTOS PODERÃO SOFRER ALTERAÇÕES SEM AVISO PRÉVIO.

ENTRE EM CONTATO COM O SEU CONSULTOR OU FALE COM O NOSSO TIME DE TELEVENDAS PELO (33) 3277-3030.

# LAND 21 velocidades Mecânico



29" WHEELS

Urbana

Alumínio

Mega Over

21 velocidades

Mecânico

Kg 14.56

**QUADRO** Aro 29" | Rava Land | Alumínio 6061 | Cabeamento interno | Direção Mega Over de 44 mm esferada | Canote 27.2 | Central BSA 68 mm | Suporte de freio Standard | Eixo traseiro 135 mm x 9 mm | Largura do pneu: 2.20 | Blocação de rodas, canote e selim.

**GARFO** Garfo Rava 29" | Suspensão 100 mm aço | Suporte de freio Standard | Espiga over ahead set | Eixo 9 mm | Old 100 mm

**SUSPENSÃO TRASEIRA** N/A

**MOVIMENTO DE DIREÇÃO** Mega Over semi-integrada 44 mm | Ahead set | Esferada | Caixa de aço | Acabamento de alumínio

**GUIDÃO** 31.8 x 730 mm | Alumínio | Rise bar (baixo) | ou | 31.8 x 740 mm | 9° backsweep | Alumínio | Reto | X-Time (envio de acordo com a disponibilidade do estoque)

**SUPORTE DE GUIDÃO** X-Time | Preto | Alumínio | 31.8 mm x 90 mm | +- 7°

**MANOPLA** Manopla MTB | Borracha

**CONJUNTO DE FREIO** X-Time | Mecânico | Pinças de alumínio | Manete MTB alumínio EZ-Fire 3x7V | Cabo de aço comum | Conduíte 5 mm teflonado

**DISCO DE FREIO** X-Time | 160 mm | 06 parafusos | Aço

**ARO/RAIO** **Aro:** Rava 29"x 32F | Alumínio MTB | Preto | Mod.02 (by Vzan ou Fly - conforme estoque) | **Folha dupla tipo aero** | **Freio a disco** **Raio:** Preto | Comum

**CUBOS** Eixo 9 mm | Blocação de alumínio | Agulha de aço **Dianteiro:** X-Time | Alumínio 32F | Esfera | Preto **Traseiro:** X-Time | Alumínio 32F | Rosca com esfera | Preto

**PNEU / CÂMARA DE AR**

**Pneu:** 29"x 2.20 | Skinwall Mount Graham Arisun **Câmara:** 29"x1.75/2.35 | Válvula americana Arisun

**PEDIVELA** Engrenagem tripla X-Time | Braço de aço revestido com nylon | Preto | Coroa 24/34/42D | Braço 170 mm | Eixo 9/16 - Inglês

**CORRENTE** 6/7/8v. | Index corrida | TEC | ou | 6/7v. | 112L | Index corrida | PYC (envio de acordo com a disponibilidade do estoque)

**EIXO CENTRAL** 34.7 mm com rolamento 122.5 mm | Selado com rolamento | Ponta quadrada

**RODA LIVRE** X-time | Index | 7V. | 14/28D | Escalonamento 14-16-18-20-22-24-28D | Xtime ou Shimano

**CÂMBIO DIANTEIRO** Shimano Tourney TZ500 | Coroa 42/34/24D | Top pull | Aço | Abraçadeira 31.8 mm

**CÂMBIO TRASEIRO** Shimano TZ31 | Aço e nylon | 7 velocidades |

**MANETE/ALAVANCA** **Alavanca:** X-Time EZ- Fire | 3x7V. | Alumínio e plástico

**SELIM** Rava MTB | Preto

**CANOTE** X-Time | MTB com carrinho | Alumínio | 27.2 x 350 mm | Preto

**ABRACADEIRA** X-Time | Alumínio | MTB 31.8mm | Blocação | Preto

**PEDAL** Plataforma | Nylon | Inglês 9/16

**URBANA** ✓

**CICLOTURISMO** X

29" NACIONAL

15.5 ■ 19934

17.5 ■ 19937

FOTOS MERAMENTE ILUSTRATIVAS. AS INFORMAÇÕES/CONFIGURAÇÕES DE PRODUTOS PODERÃO SOFRER ALTERAÇÕES SEM AVISO PRÉVIO.

ENTRE EM CONTATO COM O SEU CONSULTOR OU FALE COM O NOSSO TIME DE TELEVENDAS PELO (33) 3277-3030.



# Land

21 velocidades  
Mecânico



Urbana

Alumínio

Mega Over

21 velocidades

Mecânico

Kg 14.56



QUADRO

Aro 29" | Rava Land | Alumínio 6061 | Cabeamento interno | Direção Mega Over de 44 mm esferada | Canote 27.2 | Central BSA 68 mm | Suporte de freio Standard | Eixo traseiro 135 mm x 9 mm | Largura do pneu: 2.20 | Blocação de rodas, canote e selim.



GARFO

Garfo Rava 29" | Suspensão 100 mm aço | Suporte de freio Standard | Espiga over ahead set | Eixo 9 mm | Old 100 mm



SUSPENSÃO TRASEIRA

N/A



MOVIMENTO DE DIREÇÃO

Mega Over semi-integrada 44 mm | Ahead set | Esferada | Caixa de aço | Acabamento de alumínio



GUIDÃO

31.8 x 730 mm | Alumínio | Rise bar (baixo) | ou | 31.8 x 740 mm | 9° backsweep | Alumínio | Reto | X-Time (envio de acordo com a disponibilidade do estoque)



SUPORTE DE GUIDÃO

X-Time | Preto | Alumínio | 31.8 mm x 90 mm | +- 7°



MANOPLA

Manopla MTB | Borracha



CONJUNTO DE FREIO

X-Time | Mecânico | Pinças de alumínio | Manete MTB alumínio EZ-Fire 3x7V | Cabo de aço comum | Conduíte 5 mm teflonado



DISCO DE FREIO

X-Time | 160 mm | 06 parafusos | Aço



ARO/RAIO

**Aro:** Rava 29"x 32F | Alumínio MTB | Preto | Mod.02 (by Vzan ou Fly - conforme estoque) | Folha dupla tipo aero | Freio a disco **Raio:** Preto | Comum



CUBOS

Eixo 9 mm | Blocação de alumínio | Agulha de aço **Dianteiro:** X-Time | Alumínio 32F | Esfera | Preto **Traseiro:** X-Time | Alumínio 32F | Rosca com esfera | Preto



PNEU / CÂMARA DE AR

**Pneu:** 29"x 2.20 | Skinwall Mount Graham Arisun **Câmara:** 29"x1.75/2.35 | Válvula americana Arisun



PEDIVELA

Engrenagem tripla X-Time | Braço de aço revestido com nylon | Preto | Coroa 24/34/42D | Braço 170 mm | Eixo 9/16 - Inglês



CORRENTE

6/7/8v. | Index corrida | TEC | ou | 6/7v. | 112L | Index corrida | PYC (envio de acordo com a disponibilidade do estoque)



EIXO CENTRAL

34.7 mm com rolamento 122.5 mm | Selado com rolamento | Ponta quadrada



RODA LIVRE

X-time | Index | 7V. | 14/28D | Escalonamento 14-16-18-20-22-24-28D | Xtime ou Shimano



CÂMBIO DIANTEIRO

Shimano Tourney TZ500 | Coroa 42/34/24D | Top pull | Aço | Abraçadeira 31.8 mm



CÂMBIO TRASEIRO

Shimano TZ31 | Aço e nylon | 7 velocidades |



MANETE/ALAVANCA

**Alavanca:** X-Time EZ- Fire | 3x7V. | Alumínio e plástico



SELIM

Rava MTB | Preto



CANOTE

X-Time | MTB com carrinho | Alumínio | 27.2 x 350 mm | Preto



ABRAÇADEIRA

X-Time | Alumínio | MTB 31.8mm | Blocação | Preto



PEDAL

Plataforma | Nylon | Inglês 9/16



URBANA

✓



CICLOTURISMO

X

29" NACIONAL

15.5 19935

17.5 19938

RAVA

23

FOTOS MERAMENTE ILUSTRATIVAS. AS INFORMAÇÕES/CONFIGURAÇÕES DE PRODUTOS PODERÃO SOFRER ALTERAÇÕES SEM AVISO PRÉVIO.

ENTRE EM CONTATO COM O SEU CONSULTOR OU FALE COM O NOSSO TIME DE TELEVENDAS PELO (33) 3277-3030.

# bolt

21 velocidades  
V.Brake



Urbana

Alumínio

Mega Over

21 velocidades

V.Brake

14.60

	Quadro	Aro 26"   Rava Bolt   Alumínio   Direção Mega Over de 44 mm   Central BSA 68 mm   Canote 27.2 mm   Freio: Disco Standard(IS) e V-Brake   Eixo de 9 x 142 mm   Largura máxima de pneu: 26 x 1.9"   descanso lateral   Blocação de rodas, canote e selim.		corrente	6/7/8v.   Index corrida   TEC   ou   6/7v.   112L   Index corrida   PYC (envio de acordo com a disponibilidade do estoque)
	Garfo	Garfo com suspensão Rava,   Ahead set   Aro 26"   Freio: Disco Standard(IS) e V-Brake   Eixo 9 x 100 mm		Eixo central	BSA   34.7   Semi selado   127.5 mm   Ponta quadrada
	suspensão traseira	N/A		Roda livre	Bronze   7 v.   Index   14/28 D Xtime ou Shimano
	Movimento de direção	Mega over com rosca   Preto		Câmbio Dianteiro	Shimano Tourney TZ FD-TZ500
	Guidão	Rise bar Alto   Rava   25.4 mm   Aço com regulagem de altura		Câmbio traseiro	Sem gancheira   6/7 Velocidades   Shimano TZ-31   Index
	Suporte de guidão	Rava   Ahead   Alumínio   90 mm com ajuste de ângulo   Ø 25.4 mm		MANETE/ALAVANCA	X-Time   Dianteira/Traseira   EZ-Fire 21v. (3x7)   Com maçaneta   Alumínio   Preta
	manopla	MTB   Preta		Selim	Rava Mercúrio   Largo   Preto/Cinza   Com castanha   Regulagem de altura
	conjunto de freio	V-Brake   Preto   Dianteiro e traseiro   Alumínio   Sapata Orbital (Allen)		Canote	Rava   Para castanha   27.2 x 350 mm   Aço com regulagem de altura
	disco de freio	N/A		Abraçadeira	Alumínio   31.8   Blocação
	Aro/raio	Aro: Rava   Parede dupla   26" 559 x 19 mm   Alumínio 6063   Pneu 1.0" até 2.2"   ERD 535 mm - Raio: Preto   250 x 2,0 mm   Com Niple preto		Pedal	Plataforma   Inglês   9/16   Nylon   Preto
	Cubos	Dianteiro: Aço   36 furos   Esferado   Eixo de 9 x 100 mm   Com blocação - Traseiro: Aço   36 furos   Esferado   Roda livre   9 x 142 mm   Com Blocação		Urbana	✓
	Pneu / Câmara de ar	Pneu: Chaoyang 26" x 1,95   Banda leve   Câmara: 26" x 1,95   Válvula americana		cicloturismo	X
	Pedivela	Engrenagem tripla com braço   28/38/48D   Preto   Mitsus		trilhas intermediárias	X

26" NACIONAL

18 ■ 20550 / 20874

FOTOS MERAMENTE ILUSTRATIVAS. AS INFORMAÇÕES/CONFIGURAÇÕES DE PRODUTOS PODERÃO SOFRER ALTERAÇÕES SEM AVISO PRÉVIO.

ENTRE EM CONTATO COM O SEU CONSULTOR OU FALE COM O NOSSO TIME DE TELEVENDAS PELO (33) 3277-3030.

# bolt

21 velocidades  
V.Brake



Urbana

Alumínio

Mega Over

21 velocidades

V.Brake

Kg 14.60

Quadro

Aro 26" | Rava Bolt | Alumínio | Direção Mega Over de 44 mm | Central BSA 68 mm | Canote 27.2 mm | Freio: Disco Standard(IS) e V-Brake | Eixo de 9 x 142 mm | Largura máxima de pneu: 26 x 1.9" | descanso lateral | Blocação de rodas, canote e selim.

Garfo

Garfo com suspensão Rava, | Ahead set | Aro 26" | Freio: Disco Standard(IS) e V-Brake | Eixo 9 x 100 mm

suspensão traseira

N/A

Movimento de direção

Mega over com rosca | Preto

Guidão

Rise bar Alto | Rava | 25.4 mm | Aço com regulagem de altura

Suporte de guidão

Rava | Ahead | Alumínio | 90 mm com ajuste de ângulo | Ø 25.4 mm

manopla

MTB | Preta

conjunto de freio

V-Brake | Preto | Dianteiro e traseiro | Alumínio | Sapata Orbital (Allen)

disco de freio

N/A

Aro/raio

Aro: Rava | Parede dupla | 26" 559 x 19 mm | Alumínio 6063 | Pneu 1.0" até 2.2" | ERD 535 mm - Raio: Preto | 250 x 2,0 mm | Com Niple preto

Cubos

Dianteiro: Aço | 36 furos | Esferado | Eixo de 9 x 100 mm | Com blocação - Traseiro: Aço | 36 furos | Esferado | Roda livre | 9 x 142 mm | Com Blocação

Pneu / Câmara de ar

Pneu: Chaoyang 26" x 1,95 | Banda leve Câmara: 26" x 1,95 | Válvula americana

Pedivela

Engrenagem tripla com braço | 28/38/48D | Preto | Mits

corrente

6/7/8v. | Index corrida | TEC | ou | 6/7v. | 112L | Index corrida | PYC (envio de acordo com a disponibilidade do estoque)

Eixo central

BSA | 34.7 | Semi selado | 127.5 mm | Ponta quadrada

Roda livre

Bronze | 7 v. | Index | 14/28 D Xtime ou Shimano

Câmbio Dianteiro

Shimano Tourney TZ FD-TZ500

Câmbio traseiro

Sem gancheira | 6/7 Velocidades | Shimano TZ-31 | Index

MANETE/ALAVANCA

X-Time | Dianteira/Traseira | EZ-Fire 21v. (3x7) | Com maçaneta | Alumínio | Preta

Selim

Rava Mercúrio | Largo | Preto/Cinza | Com castanha | Regulagem de altura

Canote

Rava | Para castanha | 27.2 x 350 mm | Aço com regulagem de altura

Abraçadeira

Alumínio | 31.8 | Blocação

Pedal

Plataforma | Inglês | 9/16 | Nylon | Preto

Urbana

✓

cicloturismo

X

trilhas intermediárias

X

26" NACIONAL

18 20549 / 20873

RAVA

25

FOTOS MERAMENTE ILUSTRATIVAS. AS INFORMAÇÕES/CONFIGURAÇÕES DE PRODUTOS PODERÃO SOFRER ALTERAÇÕES SEM AVISO PRÉVIO.

ENTRE EM CONTATO COM O SEU CONSULTOR OU FALE COM O NOSSO TIME DE TELEVENDAS PELO (33) 3277-3030.

# Way

21 velocidades  
Mecânico



Urbana

Alumínio

Mega Over

21 velocidades

Mecânico

Kg 13.68

**QUADRO** Aro 29" | MTB Rava Way | Alumínio 6061 | Direção Mega Over semi-integrada caixa 44 mm de rosca | Canote 27.2 mm | Caixa central BSA 68 mm | Suporte de freio Standard | Eixo traseiro 135 mm x 9 mm | Largura do pneu 2.20

**GARFO** 29" | Aço RA+A12:B16VA | Rígido | Preto | Suporte de freio Standard | Espiga over rosca | Eixo 9 mm | Old 100 mm

**SUSPENSÃO TRASEIRA** N/A

**MOVIMENTO DE DIREÇÃO** Mega Over semi-integrada 44 mm com rosca | Esferado | Caixa de aço | Acabamento com porca de aço

**GUIDÃO** X-time | Rise Bar alto | Preto | Aço | 25.4 mm x 700 mm

**SUPOORTE DE GUIDÃO** Suporte Guidão X-TIME 25.4 mm | Preto | Alumínio | Regulagem -30°/+30° | Chanfrado

**MANOPLA** Manopla MTB | Borracha

**CONJUNTO DE FREIO** X-TIME | Mecânico | Pinças de alumínio | Manete MTB de alumínio EZ-Fire 3x7v | Cabo de aço comum | Conduíte de 5 mm teflonado

**DISCO DE FREIO** X-TIME | 160 mm | 06 parafusos | Aço

**ARO/RAIO** Aro 29" x 32 F | Alumínio MTB RAVA | Preto | Folha dupla tipo aero | Freio a disco | Raio preto comum

**CUBOS** Eixo 9 mm | Blocagem de alumínio (agulha de aço) **Dianteiro:** X-TIME | Alumínio | 32 furos | Esferado | Preto - **Traseiro:** X-TIME | Alumínio | 32 furos | Esferado | Rosca | Preto

**PNEU / CÂMARA DE AR** **Pneu:** Skinwall Mount Graham Arisun | 29" x 2.20 **Câmara:** 29" x 1.75/2.35 | Válvula americana Arisun

**PEDIVELA** Engrenagem X-TIME tripla | Braço de aço revestido com nylon | Preto | Coroa fixa de aço (24/34/42D) | Braço 170 mm | Eixo 9/16 | Inglês

**CORRENTE** Corrente corrida 7/8V TEC | Index

**EIXO CENTRAL** X-TIME 34.7 mm com rolamento 122.5 mm | Selado com rolamento | Ponta quadrada

**RODA LIVRE** Roda livre 7V. X-TIME | Index 14/28D | Escalonamento 14-16-18-20-22-24-28D Xtime ou Shimano

**CÂMBIO DIANTEIRO** Shimano Tourney TZ500 | Coroas 42/34/24D | Down Pull | Aço | Abraçadeira 31.8 mm

**CÂMBIO TRASEIRO** Shimano Tourney TZ 31 7 V | Aço e nylon

**MANETE/ALAVANCA** Alavanca X-TIME EZ- Fire 3x7 V | Alumínio e plástico

**SELIM** Rava confort | Vazado | Preto | Com castanha | Aço

**CANOTE** Canote selim X-TIME | Preto | 27.2 x 350 mm | Aço

**ABRAÇADEIRA** Abraçadeira de selim X-TIME MTB 31.8mm | Alumínio | Blocagem | Preto

**PEDAL** Plataforma | Nylon | Inglês 9/16

**DESCANSO** Lateral | Aço | Fixado no Chainstay

**URBANA** ✓

**CICLOTURISMO** X

**TRILHAS INTERMEDIÁRIAS** X

**COMPETIÇÃO** X

29" NACIONAL 16 ■ 19939 18 ■ N/A

FOTOS MERAMENTE ILUSTRATIVAS. AS INFORMAÇÕES/CONFIGURAÇÕES DE PRODUTOS PODERÃO SOFRER ALTERAÇÕES SEM AVISO PRÉVIO.

ENTRE EM CONTATO COM O SEU CONSULTOR OU FALE COM O NOSSO TIME DE TELEVENDAS PELO (33) 3277-3030.

# pressure jr



20" WHEELS

Aço

Mega Over

07 velocidades

Disco Mecânico

13.08 Kg

 <b>QUADRO</b>	Aro 20"   Rava Pressure Jr   Aço   Direção Mega Over   M. Central BSA   Freio: DiscoStandard (IS)   Suporte para descanso   Descanso Lateral	 <b>PNEU / CÂMARA DE AR</b>	<b>Pneu:</b> Pneu 20 x 2.1" <b>Câmara:</b> 20"   Válvula americana
 <b>GARFO</b>	Garfo suspensão Rava   Aro 20"   Freio: Disco Standard (IS)   Aço   Espiga Over headset	 <b>PEDIVELA</b>	Engrenagem Single   40 dentes   Braço 160 mm   Aço
 <b>SUSPENSÃO TRASEIRA</b>	N/A	 <b>CORRENTE</b>	Tec   7 Velocidades
 <b>MOVIMENTO DE DIREÇÃO</b>	Mega Over   Semi-integrado   Esfera	 <b>EIXO CENTRAL</b>	Rosca   34.7 x 113 mm   Ponta quadrada
 <b>GUIDÃO</b>	Rise bar   Aço   31.8 x 620 mm	 <b>RODA LIVRE</b>	Roda Livre 7V.   14/28D.   Index
 <b>SUPORTE DE GUIDÃO</b>	Alumínio   31.8 mm   90 mm	 <b>CÂMBIO DIANTEIRO</b>	N/A
 <b>MANOPLA</b>	MTB   Borracha	 <b>CÂMBIO TRASEIRO</b>	Shimano   7 Velocidades   Index   RD-TZ31A
 <b>CONJUNTO DE FREIO</b>	Freio a disco mecânico   Dianteiro/Traseiro	 <b>ALAVANCA</b>	Shimano   Revoshift   7 velocidades
 <b>DISCO DE FREIO</b>	160 mm   Aço   Parafuso	 <b>SELIM</b>	Rava   Com castanha   Trilho de aço
 <b>ARO/RAIO</b>	Aro: Rava 20"   Parede dupla   Freio a disco   Alumínio   Raio (Aço) Preto com niple	 <b>CANOTE</b>	Para castanha   27.2 x 250 mm   Aço
 <b>CUBOS</b>	<b>Dianteiro:</b> Aço   36 furos   Freio a disco (Parafuso) - <b>Traseiro:</b> Aço   36 furos   Rosca (Roda livre)   Freio a disco (Parafuso)	 <b>ABRAÇADEIRA</b>	Abraçadeira 31.8mm   Blocagem
		 <b>PEDAL</b>	Plataforma   Preto   Nylon

## 20" IMPORTADA

ÚNICO  17412

ÚNICO  17413

ÚNICO  17414

FOTOS MERAMENTE ILUSTRATIVAS. AS INFORMAÇÕES/CONFIGURAÇÕES DE PRODUTOS PODERÃO SOFRER ALTERAÇÕES SEM AVISO PRÉVIO.

ENTRE EM CONTATO COM O SEU CONSULTOR OU FALE COM O NOSSO TIME DE TELEVENDAS PELO (33) 3277-3030.

# Nina Teen



	<b>QUADRO</b>	Rava Nina Teen   Paralamas: Nylon   Cesta: Arame preto   Porta corrente: Nylon inteiriço (cobre toda a parte externa da transmissão)   Rodinhas: Aço reforçada e emborrachada
	<b>GARFO</b>	Aço   Aro 20" Rosca   Suporte para freio v-brake
	<b>SUSPENSÃO TRASEIRA</b>	N/A
	<b>MOVIMENTO DE DIREÇÃO</b>	Standard   Esferada
	<b>GUIDÃO</b>	Curvado   Aço   Preto   25.4mm/550mm
	<b>SUPORTE DE GUIDÃO</b>	Chanfrado   Alumínio
	<b>MANOPLA</b>	Nylon
	<b>CONJUNTO DE FREIO</b>	V-Brake   Aço   Manete: Nylon com reguladores
	<b>DISCO DE FREIO</b>	N/A
	<b>ARO/RAIO</b>	Aro: 20"   Alumínio preto   Folha simples   28 furos   Raio: Aço preto   2mmx190mm

	<b>CUBOS</b>	Aço preto   28 furos   Eixo maciço com porca
	<b>PNEU / CÂMARA DE AR</b>	Aro 20"   20x2.125   Importado
	<b>PEDIVELA</b>	Monobloco   140mm   Aço   Preto
	<b>CORRENTE</b>	Bronze Maya   Importada
	<b>MOVIMENTO CENTRAL</b>	Esferado   50mm
	<b>RODA LIVRE</b>	Bronze   16 Dentes   Importado
	<b>CÂMBIO DIANTEIRO</b>	N/A
	<b>CÂMBIO TRASEIRO</b>	N/A
	<b>ALAVANCA</b>	N/A
	<b>SELIM</b>	Infantil com suporte de apoio   Castanha
	<b>CANOTE</b>	Aço preto   25.4mmx250mm
	<b>ABRAÇADEIRA</b>	N/A
	<b>PEDAL</b>	Nylon sueco 1/2

20" IMPORTADA

ÚNICO  17408

ÚNICO  17409

FOTOS MERAMENTE ILUSTRATIVAS. AS INFORMAÇÕES/CONFIGURAÇÕES DE PRODUTOS PODERÃO SOFRER ALTERAÇÕES SEM AVISO PRÉVIO.

ENTRE EM CONTATO COM O SEU CONSULTOR OU FALE COM O NOSSO TIME DE TELEVENDAS PELO (33) 3277-3030.

# Nina Teen



QUADRO

Rava Nina Teen 16" | Aço | **Paralamas:** Nylon sem haste | **Porta corrente:** Nylon inteiriço (cobre toda a parte externa da transmissão) | **Rodinhas:** Aço reforçada e emborrachada | **Acessórios de proteção:** no suporte e na barra de guidão



GARFO

Rava | Aço | Aro 16"



SUSPENSÃO TRASEIRA

N/A



MOVIMENTO DE DIREÇÃO

Standard | Rosca | Esferada



GUIDÃO

Cross | 25.4 mm | Aço



SUPORTE DE GUIDÃO

Chanfrado | Aço



MANOPLA

Nylon



CONJUNTO DE FREIO

V-Brake | Aço | **Manete:** MTB de nylon com reguladores | Alumínio



DISCO DE FREIO

N/A



ARO/RAIO

**Aro:** 16" | Alumínio | Preto | Folha simples | 20 furos **Raio:** Zincado



CUBOS

Aço | Eixo 9 mm | Porca sextavada | 20 F



PNEU / CÂMARA DE AR

Aro 16" x 2.125 | Importado **Câmara:** Aro 16" | Válvula americana



PEDIVELA

Monobloco | 115 mm | Preto



CORRENTE

Comum | Importada



MOVIMENTO CENTRAL

Esferado | 50mm



RODA LIVRE

16 Dentes | Coroa 32 D | Aço



CÂMBIO DIANTEIRO

N/A



CÂMBIO TRASEIRO

N/A



ALAVANCA

N/A



SELIM

Infantil com suporte de apoio



CANOTE

Aço | 25.4 mm



ABRAÇADEIRA

N/A



PEDAL

Infantil | Nylon sueco 1/2 | Preto

16" IMPORTADA

ÚNICO ■ 17404

ÚNICO ■ 17405

# Sunny | PRO



RAVA

30

	<b>QUADRO</b>	Rava Sunny-pro   Balance   Aro 12"   Aço   Apoio de nylon para os pés
	<b>GARFO</b>	Rava   Rígido   Aro 12"   Aço
	<b>CAIXA DE DIREÇÃO</b>	Sueca   Com rosca   Esferada
	<b>GUIDÃO</b>	Aço   Rise bar   25.4 x 420 mm
	<b>SUPORTE DE GUIDÃO</b>	Aço   Tipo sueco
	<b>MANOPLA</b>	Borracha
	<b>CONJUNTO DE FREIO</b>	Tambor   Maçaneta de Nylon
	<b>ARO/RAIO</b>	Aro: Aço   12" / Raio: Preto   2.0 mm
	<b>CUBOS</b>	Aço com esfera   Eixo de 9 mm
	<b>PNEU / CÂMARA DE AR</b>	Pneu com cravo   12 x 2.25" / Câmara com válvula americana
	<b>CANOTE</b>	Aço   25.4 mm   Selim integrado
	<b>ABRAÇADEIRA</b>	Alumínio   Parafuso

## IMPORTADA

12" 17402

12" 17403

FOTOS MERAMENTE ILUSTRATIVAS. AS INFORMAÇÕES/CONFIGURAÇÕES DE PRODUTOS PODERÃO SOFRER ALTERAÇÕES SEM AVISO PRÉVIO.

ENTRE EM CONTATO COM O SEU CONSULTOR OU FALE COM O NOSSO TIME DE TELEVENDAS PELO (33) 3277-3030.



# Sunny



	<b>QUADRO</b>	Rava Sunny   Balance   Aro 12"   Aço
	<b>GARFO</b>	Rava   Rígido   Aro 12"   Aço
	<b>CAIXA DE DIREÇÃO</b>	Bucha
	<b>GUIDÃO</b>	Aço   Reto   Integrado
	<b>MANOPLA</b>	Borracha
	<b>RODA</b>	Aro 12"   Nylon   Pneu EVA semi-rígido
	<b>CANOTE</b>	Aço   25.4 mm   Selim integrado

## IMPORTADA

12"		17497
12"		17498
12"		17499
12"		17500



GRUPO  
**JPP**

AVENIDA INDUSTRIAL 312, DISTRITO INDUSTRIAL  
GOVERNADOR VALADARES - MINAS GERAIS/BRASIL

BIKE@GRUPOJPP.COM.BR

(33) 3277-3030

WWW.GRUPOJPP.COM.BR





*metz*



CATÁLOGO

B I C I C L E T A S

21 de Novembro 2023



# fuse+

AQUI TEM

SHIMANO

QUALIDADE  
CONFIANÇA



#SEMPRESHIMANO

29"  
WHEELS



QUADRO

MTB METZ 29" | Alumínio 6061 | Cabeamento externo | Direção Mega Over semi-integrada Ø 44 x 44 mm | Suporte de freio a disco standard dentro do triângulo traseiro | Caixa central BSA 68 mm | Eixo traseiro 9 x 135mm | Canote 27.2 mm | Largura máxima do pneu 29 x 2.2" com cravo baixo | Peso máximo suportado de 110 kg (PESO DO CICLISTA + ACESSÓRIOS)



SUSPENSÃO  
DIANTEIRA

29" | Rava | 100 mm | Mola | Over Head Set | (OLD) 9 x 100 mm | Lower leg | Garfo de aço



SUSPENSÃO  
TRASEIRA

N/A



MOVIMENTO DE  
DIREÇÃO

Mega Over semi-integrada Ø 44 x 44 mm | Esfera | Caixa de aço



GUIDÃO

X-Time | Alumínio | Reto | 31.8 x 740 mm | 9° Backsweep



SUPORTE DE  
GUIDÃO

X-Time | Alumínio | Ahead | 90 mm | 7°



MANOPLA

MTB Preta



CONJUNTO DE  
FREIO

Disco | Mecânico | X-Time



DISCO DE FREIO

160 mm | Parafuso | Aço



ARO/RAIO

RAVA MTB | 29" | 32 furos | Folha dupla aero | By Fly/Vzan



CUBOS

X-Time | Rosca | Alumínio | 32 furos | Esfera



PNEU / CÂMARA  
DE AR

**Pneu:** Arisun Graham | Skinwall | 29"  
**Câmara de ar:** Arisun | Válvula americana



PEDIVELA

Shimano TY-301 | Engrenagem tripla com braço | 170 mm | 24/34/42D.



CORRENTE

TEC | 7 velocidades



MOVIMENTO  
CENTRAL

34.7 C/ ROL. 122.5mm



RODA LIVRE

Shimano TZ 500 | 7 velocidades | 14-28D. | Rosca



CÂMBIO  
DIANTEIRO

TZ 500 | Shimano | TOP PULL 31.8mm



CÂMBIO TRASEIRO

Tourney T200 | Shimano | 7 velocidades



ALAVANCA

Alavanca/Manete de freio | Shimano EF-41 | 21 velocidades



SELIM

Selle Royal MTB Sport PU Trilho de Aço



CANOTE

27.2 x 350 mm | Aço | Para castanha | Importado | Regulagem de altura



ABRAÇADEIRA

X-Time | Alumínio | 31.8 | Blocagem



PEDAL

Plataforma | MTB | Inglês 9/16 | Nylon | Preto



URBANA

✓



CICLOTURISMO

X



TRILHAS  
INTERMEDIÁRIAS

X



COMPETIÇÃO

X



PESO APROXIMADO

15.05 kg (17")

29" NACIONAL

15.5 20941

metz

249

FOTOS MERAMENTE ILUSTRATIVAS. AS INFORMAÇÕES/CONFIGURAÇÕES DE PRODUTOS PODERÃO SOFRER ALTERAÇÕES SEM AVISO PRÉVIO.

ENTRE EM CONTATO COM O SEU CONSULTOR OU FALE COM O NOSSO TIME DE TELEVENDAS PELO (33) 3277-3030.



# fuse+

AQUI TEM

SHIMANO

QUALIDADE CONFIANÇA



#SEMPRESHIMANO

29" WHEELS



metz



QUADRO

MTB METZ 29" | Alumínio 6061 | Cabeamento externo | Direção Mega Over semi-integrada Ø 44 x 44 mm | Suporte de freio a disco standard dentro do triângulo traseiro | Caixa central BSA 68 mm | Eixo traseiro 9 x 135mm | Canote 27.2 mm | Largura máxima do pneu 29 x 2.2" com cravo baixo | Peso máximo suportado de 110 kg (PESO DO CICLISTA + ACESSÓRIOS)



SUSPENSÃO DIANTEIRA

29" | Rava | 100 mm | Mola | Over Head Set | (OLD) 9 x 100 mm | Lower leg | Garfo de aço



SUSPENSÃO TRASEIRA

N/A



MOVIMENTO DE DIREÇÃO

Mega Over semi-integrada Ø 44 x 44 mm | Esfera | Caixa de aço



GUIDÃO

X-Time | Alumínio | Reto | 31.8 x 740 mm | 9° Backsweep



SUPOORTE DE GUIDÃO

X-Time | Alumínio | Ahead | 90 mm | 7°



MANOPLA

MTB Preta



CONJUNTO DE FREIO

Disco | Mecânico | X-Time



DISCO DE FREIO

160 mm | Parafuso | Aço



ARO/RAIO

RAVA MTB | 29" | 32 furos | Folha dupla aero | By Fly/Vzan



CUBOS

X-Time | Rosca | Alumínio | 32 furos | Esfera



PNEU / CÂMARA DE AR

**Pneu:** Arisun Graham | Skinwall | 29"  
**Câmara de ar:** Arisun | Válvula americana



PEDIVELA

Shimano TY-301 | Engrenagem tripla com braço | 170 mm | 24/34/42D.



CORRENTE

TEC | 7 velocidades



MOVIMENTO CENTRAL

34.7 C/ ROL. 122.5mm



RODA LIVRE

Shimano TZ 500 | 7 velocidades | 14-28D. | Rosca



CÂMBIO DIANTEIRO

TZ 500 | Shimano | TOP PULL 31.8mm



CÂMBIO TRASEIRO

Tourney T200 | Shimano | 7 velocidades



ALAVANCA

Alavanca/Manete de freio | Shimano EF-41 | 21 velocidades



SELIM

Selle Royal MTB Sport PU Trilho de Aço



CANOTE

27.2 x 350 mm | Aço | Para castanha | Importado | Regulagem de altura



ABRACADEIRA

X-Time | Alumínio | 31.8 | Blocagem



PEDAL

Plataforma | MTB | Inglês 9/16 | Nylon | Preto



URBANA

✓



CICLOTURISMO

X



TRILHAS INTERMEDIÁRIAS

X



COMPETIÇÃO

X



PESO APROXIMADO

15.05 kg (17")

29" NACIONAL

15.5

20942

FOTOS MERAMENTE ILUSTRATIVAS. AS INFORMAÇÕES/CONFIGURAÇÕES DE PRODUTOS PODERÃO SOFRER ALTERAÇÕES SEM AVISO PRÉVIO.

ENTRE EM CONTATO COM O SEU CONSULTOR OU FALE COM O NOSSO TIME DE TELEVENDAS PELO (33) 3277-3030.

# fuse



29"  
WHEELS



QUADRO

MTB METZ 29" | Alumínio 6061 | Cabeamento externo | Direção Mega Over semi-integrada Ø 44 x 44 mm | Suporte de freio a disco standard dentro do triângulo traseiro | Caixa central BSA 68 mm | Eixo traseiro 9 x 135mm | Canote 27.2 mm | Largura máxima do pneu 29 x 2.2" com cravo baixo | Peso máximo suportado de 110 kg (PESO DO CICLISTA + ACESSÓRIOS)



SUSPENSÃO DIANTEIRA

Garfo 29" Rava MTB com suspensão | Lower leg de aço | Kraw de alumínio | Eixo de 9 mm | Curso de 80 mm



SUSPENSÃO TRASEIRA

N/A



MOVIMENTO DE DIREÇÃO

Mega Over semi-integrada 44 mm | Esferada | Caixa de aço | Acabamento em alumínio



GUIDÃO

X-Time | Alumínio | Rise bar (baixo) | 31.8 x 740 mm



SUPOORTE DE GUIDÃO

X-Time | Ahead | Alumínio | 31.8 x 90 mm / +-7°



MANOPLA

MTB Preta



CONJUNTO DE FREIO

X-Time | Disco | Mecânico | Dianteiro/Traseiro



DISCO DE FREIO

X-Time | 160 mm | 06 parafusos | Aço



ARO/RAIO

Rava | Alumínio 6063 | 622x19mm | ERD 584 mm | Parede dupla | 32F | Raio preto



CUBOS

Cubo Alumínio | Eixo 9 mm | Blocação de alumínio (agulhade aço) | 32F | Roda livre rosca | Esferas | Preto



PNEU / CÂMARA DE AR

**Pneu:** Arisun Skinwall Mount Graham 29x2.20  
**Câmara de ar:** Arisun 29" | Válvula americana



PEDIVELA

X-Time | Engrenagem tripla | Braço 170 mm | Coroas 42/34/24D | Aço/Nylon



CORRENTE

Tec | 6/7/8v



MOVIMENTO CENTRAL

Eixo 34.7 mm | Com rolamento | 122.5 mm | Ponta quadrada



RODA LIVRE

X-TIME | 7 velocidades | 14-28D



CÂMBIO DIANTEIRO

Shimano TZ 500 | Dual



CÂMBIO TRASEIRO

Shimano TZ 31



ALAVANCA

Passador de marcha/alavanca do freio Dianteira/Traseira | X-Time 3 x 7v.



SELIM

Selle Royal MTB Sport PU Trilho de Aço



CANOTE

27.2 x 350 mm | Aço | Para castanha | Importado | Regulagem de altura



ABRAÇADEIRA

X-Time | Alumínio | 31.8 | Blocação



PEDAL

Inglês | Preto | Nylon



URBANA

✓

29" NACIONAL

17  20917

metz

251

FOTOS MERAMENTE ILUSTRATIVAS. AS INFORMAÇÕES/CONFIGURAÇÕES DE PRODUTOS PODERÃO SOFRER ALTERAÇÕES SEM AVISO PRÉVIO.

ENTRE EM CONTATO COM O SEU CONSULTOR OU FALE COM O NOSSO TIME DE TELEVENDAS PELO (33) 3277-3030.











# fuse



29"  
WHEELS

METZ

252

	<b>QUADRO</b>	MTB METZ 29"   Alumínio 6061   Cabeamento externo   Direção Mega Over semi-integrada Ø 44 x 44 mm   Suporte de freio a disco standard dentro do triângulo traseiro   Caixa central BSA 68 mm   Eixo traseiro 9 x 135mm   Canote 27.2 mm   Largura máxima do pneu 29 x 2.2" com cravo baixo   Peso máximo suportado de 110 kg (PESO DO CICLISTA + ACESSÓRIOS)
	<b>SUSPENSÃO DIANTEIRA</b>	Garfo 29" Rava MTB com suspensão   Lower leg de aço   Kraw de alumínio   Eixo de 9 mm   Curso de 80 mm
	<b>SUSPENSÃO TRASEIRA</b>	N/A
	<b>MOVIMENTO DE DIREÇÃO</b>	Mega Over semi-integrada 44 mm   Esferada   Caixa de aço   Acabamento em alumínio
	<b>GUIDÃO</b>	X-Time   Alumínio   Rise bar (baixo)   31.8 x 740 mm
	<b>SUporte DE GUIDÃO</b>	X-Time   Ahead   Alumínio   31.8 x 90 mm / +-7°
	<b>MANOPLA</b>	MTB Preta
	<b>CONJUNTO DE FREIO</b>	X-Time   Disco   Mecânico   Dianteiro/Traseiro
	<b>DISCO DE FREIO</b>	X-Time   160 mm   06 parafusos   Aço
	<b>ARO/RAIO</b>	Rava   Alumínio 6063   622x19mm   ERD 584 mm   Parede dupla   32F   Raio preto
	<b>CUBOS</b>	Cubo Alumínio   Eixo 9 mm   Blocação de alumínio (agulhade aço)   32F   Roda livre rosca   Esferas   Preto
	<b>PNEU / CÂMARA DE AR</b>	<b>Pneu:</b> Arisun Skinwall Mount Graham 29x2.20 <b>Câmara de ar:</b> Arisun 29"   Válvula americana
	<b>PEDIVELA</b>	X-Time   Engrenagem tripla   Braço 170 mm   Coroas 42/34/24D   Aço/Nylon

	<b>CORRENTE</b>	Tec   6/7/8v
	<b>MOVIMENTO CENTRAL</b>	Eixo 34.7 mm   Com rolamento   122.5 mm   Ponta quadrada
	<b>RODA LIVRE</b>	X-TIME   7 velocidades   14-28D
	<b>CÂMBIO DIANTEIRO</b>	Shimano TZ 500   Dual
	<b>CÂMBIO TRASEIRO</b>	Shimano TZ 31
	<b>ALAVANCA</b>	Passador de marcha/alavanca do freio Dianteira/Traseira   X-Time 3 x 7v.
	<b>SELIM</b>	Selle Royal MTB Sport PU Trilho de Aço
	<b>CANOTE</b>	27.2 x 350 mm   Aço   Para castanha   Importado   Regulagem de altura
	<b>ABRAÇADEIRA</b>	X-Time   Alumínio   31.8   Blocação
	<b>PEDAL</b>	Inglês   Preto   Nylon
	<b>URBANA</b>	✓

29" NACIONAL

15.5  20915

FOTOS MERAMENTE ILUSTRATIVAS. AS INFORMAÇÕES/CONFIGURAÇÕES DE PRODUTOS PODERÃO SOFRER ALTERAÇÕES SEM AVISO PRÉVIO.

ENTRE EM CONTATO COM O SEU CONSULTOR OU FALE COM O NOSSO TIME DE TELEVENDAS PELO (33) 3277-3030.



GRUPO  
**JPP**

AVENIDA INDUSTRIAL 312, DISTRITO INDUSTRIAL  
GOVERNADOR VALADARES - MINAS GERAIS/BRASIL

BIKE@GRUPOJPP.COM.BR

**(33) 3277-3030**

**WWW.GRUPOJPP.COM.BR**





Versão: 07 de Fevereiro 2024

# CATÁLOGO DE **COMPONENTES** E ACESSÓRIOS



\*O Catálogo é atualizado constantemente.  
Antes de baixar, verifique a versão com data atualizada.





 QUEST  
L I N E



## GUIDÃO RETO 6° 800MM C/SUP 2° CRB PT | LINHA QUEST

<b>CARACTERÍSTICA</b>	<p>Guidão reto com suporte integrado -2°   linha quest</p> <ul style="list-style-type: none"> <li>• Guidão de carbono</li> <li>• Suporte de guidão integrado de 50mm, 60mm e 70mm</li> <li>• -2° Negativo</li> </ul>	<p><b>50 MM</b> 22240</p> <p><b>60 MM</b> 22241</p> <p><b>70 MM</b> 22242</p>
<b>MATERIAL</b>	Material carbono ud (ud matt carbon fiber t800)	
<b>TAMANHO</b>	<ul style="list-style-type: none"> <li>• Diâmetro de fixação da espiga 28.6mm</li> <li>• tamanho 800mm</li> </ul>	
<b>UPSWEEP</b>	6°	
<b>BACKSWEEP</b>	6°	
<b>RISE</b>	0	
<b>PESO</b>	309gr - peso referente ao guidão 60mm	
<b>EMBALAGEM</b>	15 peças	

FOTOS MERAMENTE ILUSTRATIVAS. AS INFORMAÇÕES/CONFIGURAÇÕES DE PRODUTOS PODERÃO SOFRER ALTERAÇÕES SEM AVISO PRÉVIO.

ENTRE EM CONTATO COM O SEU CONSULTOR OU FALE COM O NOSSO TIME DE TELEVENDAS PELO (33) 3277-3030.



### GUIDÃO RETO 9° 800MM CRB PT | LINHA QUEST

<b>CARACTERÍSTICA</b>	Guidão reto   linha quest • Guidão de carbono
<b>MATERIAL</b>	Material carbono ud (ud matt carbon fiber t800)
<b>TAMANHO</b>	Tamanho 800x31.8mm
<b>UPSWEEP</b>	0°
<b>BACKSWEEP</b>	9°
<b>PESO</b>	195g
<b>EMBALAGEM</b>	25 peças

22244

QUEST

FOTOS MERAMENTE ILUSTRATIVAS. AS INFORMAÇÕES/CONFIGURAÇÕES DE PRODUTOS PODERÃO SOFRER ALTERAÇÕES SEM AVISO PRÉVIO.

ENTRE EM CONTATO COM O SEU CONSULTOR OU FALE COM O NOSSO TIME DE TELEVENDAS PELO (33) 3277-3030.

## CANOTE SELIM ALUM. 31.6 X 400MM SLIM PT | LINHA QUEST

<b>CARACTERÍSTICA</b>	• Micro ajuste • Limite inserção 130mm
<b>MATERIAL</b>	Alumínio
<b>TAMANHO</b>	400 X 31.6mm
<b>PESO</b>	300 g
<b>EMBALAGEM</b>	25 peças
	23868



## GUIDÃO ALUM. MTB 31.8 MM X 740 MM RETO PT | LINHA QUEST

<b>MATERIAL</b>	Alumínio	<b>RISE</b>	0°
<b>CARACTERÍSTICA</b>	Guidão de Alumínio	<b>PESO</b>	298g
<b>TAMANHO</b>	740 x 31.8 mm	<b>EMBALAGEM</b>	15 peças
<b>UPSWEEP</b>	0°		23851
<b>BACKSWEEP</b>	9°		

## GUIDÃO ALUM. DH 35MM X 800 MM PT | LINHA QUEST

<b>MATERIAL</b>	Alumínio	<b>RISE</b>	15°
<b>CARACTERÍSTICA</b>	Guidão de Alumínio DH	<b>PESO</b>	304g
<b>TAMANHO</b>	800 x 35 mm	<b>EMBALAGEM</b>	15 peças
<b>UPSWEEP</b>	0°		23852
<b>BACKSWEEP</b>	7°		

FOTOS MERAMENTE ILUSTRATIVAS. AS INFORMAÇÕES/CONFIGURAÇÕES DE PRODUTOS PODERÃO SOFRER ALTERAÇÕES SEM AVISO PRÉVIO.

ENTRE EM CONTATO COM O SEU CONSULTOR OU FALE COM O NOSSO TIME DE TELEVENDAS PELO (33) 3277-3030.

**SUP. DE GUIDÃO ALUM. MTB AHEAD  
LIGHT 80 MM 17° PT | LINHA QUEST**

<b>MATERIAL</b>	Alumínio
<b>TAMANHO</b>	70 mm   80 mm / 17°
<b>CARACTERÍSTICA</b>	<ul style="list-style-type: none"><li>• Over Ahead Set</li><li>• Light</li><li>• Compatível com Guidão 31.8 mm</li></ul>
<b>PESO</b>	129g (referente ao suporte 80 mm)
<b>EMBALAGEM</b>	20 peças

23864 - 80 MM

23865 - 70 MM



**SUPORTE DE GUIDÃO ALUM.  
DH 35 X 45 MM | LINHA QUEST**

<b>MATERIAL</b>	Alumínio
<b>TAMANHO</b>	35 x 45 mm
<b>CARACTERÍSTICA</b>	<ul style="list-style-type: none"><li>• Suporte de Guidão Alumínio DH</li><li>• Ângulo 0°</li><li>• Over ahead Set</li><li>• Compatível com Guidão 35 mm</li></ul>
<b>PESO</b>	151g
<b>EMBALAGEM</b>	20 peças

23866



## SUP. DE GUIDÃO ALUM. MTB AHEAD 80 MM 5° PT | LINHA QUEST

<b>MATERIAL</b>	Alumínio
<b>TAMANHO</b>	60 mm   70 mm   80 mm   90 mm e 100 mm
<b>CARACTERÍSTICA</b>	<ul style="list-style-type: none"><li>• Suporte de Guidão Alumínio</li><li>• Ângulo 5°</li><li>• Over ahead Set</li><li>• Compatível com Guidão 31.8 mm</li><li>• Acompanha tampa de acabamento do suporte de guidão e parafuso da aranha.</li></ul>

**PESO** 151g

**EMBALAGEM** 20 peças

23877 - 60 MM / 5°

23878 - 70 MM / 5°



## SUPORTE DE GUIDÃO ALUM. MTB AHEAD 50 MM PT | LINHA QUEST

<b>MATERIAL</b>	Alumínio
<b>TAMANHO</b>	50 mm   70 mm
<b>CARACTERÍSTICA</b>	<ul style="list-style-type: none"><li>• Suporte de Guidão Alumínio</li><li>• Over ahead Set</li><li>• Compatível com Guidão 31.8 mm</li><li>• Ângulo 0°</li><li>• Acompanha tampa de acabamento do suporte de guidão e parafuso da aranha.</li></ul>

**PESO** 193g (peso suporte de 50 mm com tampa e parafuso)

**EMBALAGEM** 20 peças

23882 - 50 MM

23884 - 70 MM



FOTOS MERAMENTE ILUSTRATIVAS. AS INFORMAÇÕES/CONFIGURAÇÕES DE PRODUTOS PODERÃO SOFRER ALTERAÇÕES SEM AVISO PRÉVIO.

ENTRE EM CONTATO COM O SEU CONSULTOR OU FALE COM O NOSSO TIME DE TELEVENDAS PELO (33) 3277-3030.

## SUPORE DE GUIDÃO ALUM. MTB AHEAD INT. 80 MM 7° PT | LINHA QUEST

**MATERIAL** Alumínio e Nylon

**TAMANHO** 80 mm | 90 mm

**CARACTERÍSTICA**

- Suporte de Guidão Alumínio
- Over ahead Set
- Compatível com Guidão 31.8 mm
- Ângulo 10°
- Integrado (possibilidade de passar conduites dentro da caixa de direção)
- Acompanha acabamento inferior do suporte, calço de 10mm para regulagem na espiga, cone do rolamento superior (compatível com rolamento integrado 40x52mm), acabamento superior da caixa de direção, tampa de acabamento do suporte do guidão e parafuso aranha.

**PESO** 243g (peso suporte de 80 mm mais acessórios)

**EMBALAGEM** 20 peças

23875 - 80 MM / 10°

23876 - 90 MM / 10°



## SUPORE DE GUIDÃO ALUM. DH 35X 50 MM 12° PT | LINHA QUEST

**MATERIAL** Alumínio

**TAMANHO** 35x 50 mm

**CARACTERÍSTICA**

- Suporte de Guidão Alumínio DH
- Over ahead Set
- Compatível com Guidão 35 mm
- Ângulo 12°

**PESO** 160g

**EMBALAGEM** 20 peças

23885





## SUPORE DE GUIDÃO ALUM. MTB 80 MM 17° PT | LINHA QUEST

**MATERIAL** Alumínio

**TAMANHO** 80 mm | 100 mm

**CARACTERÍSTICA**

- Suporte de Guidão Alumínio
- Over ahead Set
- Compatível com Guidão 31.8 mm
- Ângulo 17°

**PESO** 210g

**EMBALAGEM** 20 peças

23886 - 80 MM / 17°

23887 - 100 MM / 17°



## MANOPLA PRETA MTB SILICONE GEL | LINHA QUEST

**CARACTERÍSTICA** Design moderno  
| Corpo com acabamento liso |  
Acompanha acabamentos do guidão

**MATERIAL** Silica Gel

**TAMANHO** 130 X 28mm (comprimento x largura)

**PESO** 87g (Manopla e acabamento)

**EMBALAGEM** 100 unidades

22087



## MANOPLA PRETA MTB SILICONE GEL 3 | LINHA QUEST

**CARACTERÍSTICA** Design moderno  
| Corpo com acabamento grip |  
Acompanha acabamentos do guidão

**MATERIAL** Silica Gel

**TAMANHO** 130 X 28mm (comprimento x largura)

**PESO** 77g (Manopla e acabamento)

**EMBALAGEM** 100 unidades

22088



FOTOS MERAMENTE ILUSTRATIVAS. AS INFORMAÇÕES/CONFIGURAÇÕES DE PRODUTOS PODERÃO SOFRER ALTERAÇÕES SEM AVISO PRÉVIO.

ENTRE EM CONTATO COM O SEU CONSULTOR OU FALE COM O NOSSO TIME DE TELEVENDAS PELO (33) 3277-3030.

## ABRAÇ. SELIM ALUM. MTB 34.9 PT

| Linha Quest

**CARACTERÍSTICA**

- Abraçadeira de aperto do canote
- Ajuste por parafuso
- Alumínio

**TAMANHO** • Medidas 34.9mm

**MATERIAL** Alumínio

**PESO** 24 gr

**EMBALAGEM** 200 peças

23873



## GANCHEIRA TRASEIRA PARA QUADRO MODELO 25 | LINHA QUEST

**CARACTERÍSTICA**

Gancheira para quadro de carbono QUEST

- Kit com 3 peças (Gancheira, porca, parafuso)
- Compatível com as bicicletas: TSW Full Quest TR Advanced, TSW Full Quest TR Fast, TSW Full Quest TR Starter e todas as TSW EVO Quest

**TAMANHO** 50x30x20mm (Porca M12X1.5)

**MATERIAL** Alumínio

**PESO** 19 gr – Kit completo

**EMBALAGEM** 10 peças

22971



## GANCHEIRA TRASEIRA PARA QUADRO MODELO 26 | LINHA QUEST

**CARACTERÍSTICA**

Gancheira para quadro de carbono QUEST

- Kit com 3 peças (Gancheira, Porca, Parafuso)
- Compatível com as bicicletas: TSW Full Quest Advanced +, TSW Full Quest Advanced, TSW Full Quest Advanced GX, TSW Full Quest Starter SX, TSW Full Quest Starter, TSW All Quest e TR01

**TAMANHO** 54x34x16mm (Porca M12X1.5)

**MATERIAL** Alumínio

**PESO** 15 gr – Kit completo

**EMBALAGEM** 10 peças

22972



QUEST



## KIT RODA DIANT/TRAS. ARO 29X32F MOD 04 BOOST MS PT IMP. | LINHA QUEST

**MATERIAL** Alumínio

**ARO**

- WTB kom trail i35
- Alumínio
- Acabamento anodizado
- Largura interna 35mm
- Tubeless ready
- Etrto rim size 35-622mm
- 32 furos
- Disc brake
- Largura do pneu 47mm - 72mm

**CUBO DIANTEIRO**

- Material alumínio
- Boost
- Eixo 15x110mm
- Eixo interno de alumínio
- Old 110mm
- 32 furos
- 02 rolamentos (medida 6804rs)
- Compatível com freio a disco 6 parafusos

**CUBO TRASEIRO**

- Material alumínio
- Boost
- Eixo 12x148mm
- Eixo interno de alumínio
- 32 furos
- 02 rolamentos (medida 6902-2rs)
- 02 rolamentos freehub (medidas 6802-2rs)
- Freehub padrão micro spline com 6 martelinhos
- Compatível com freio a disco 6 parafusos

**RAIO**

- Importado
- Sapin
- Inox
- 2.00mm
- Niple 2.00x14mm

**PESO**

- Roda dianteira 1.090 gr
- Roda traseira 1.220 gr
- Par 2.310GR

**EMBALAGEM**

01 peça

22786



## KIT RODA DIANT/TRAS. ARO 29X32F MOD 05 BOOST XD PT IMP. | LINHA QUEST

**MATERIAL** Alumínio

**ARO**

- WTB kom trail i35
- Alumínio
- Acabamento anodizado
- Largura interna 35mm
- Tubeless ready
- Etrto rim size 35-622mm
- 32 furos
- Disc brake
- Largura do pneu 47mm – 72mm

**CUBO DIANTEIRO**

- Material alumínio
- Boost eixo 15x110mm
- Eixo interno de alumínio
- Old 110mm
- 32 furos
- 02 rolamentos (medida 6804rs)
- Compatível com freio a disco 6 parafusos

**CUBO TRASEIRO**

- Material alumínio
- Boost eixo 12x148mm
- Eixo interno de alumínio
- 32 furos
- 02 rolamentos (medida 61902-16-2rs)
- 02 rolamentos freehub (medidas 6802-2rs)
- Freehub padrão xd com 6 martelinhos
- Compatível com freio a disco 6 parafusos

**RAIO**

- Importado
- Sapin
- Inox
- 2.00mm
- Niple 2.00x14mm

**PESO**

- Roda dianteira 1.128gr
- Roda traseira 1.211gr
- Par 2.339gr

**EMBALAGEM** 01 peça

22787

FOTOS MERAMENTE ILUSTRATIVAS. AS INFORMAÇÕES/CONFIGURAÇÕES DE PRODUTOS PODERÃO SOFRER ALTERAÇÕES SEM AVISO PRÉVIO.

ENTRE EM CONTATO COM O SEU CONSULTOR OU FALE COM O NOSSO TIME DE TELEVENDAS PELO (33) 3277-3030.

QUEST

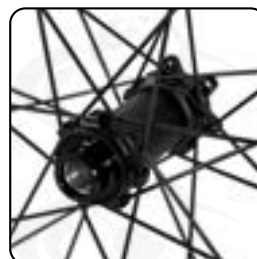

## RODA D/T. 29X28F 6P. CARBON MOD. 01 BOOST XD PT IMP.

**MATERIAL** Carbono

**ARO**

- Quest Carbon Race Q30 29"
- 30mm de largura interna
- Tecnologia Hookless, sem ganchos laterais internos
- Tubeless
- 28 furos

**CUBO DIANTEIRO**

- Material alumínio
- Boost
- Eixo 15x110mm
- Compatível com discos 6 parafusos
- 28 Furos

**CUBO TRASEIRO**

- Boost
- Eixo 12x148mm
- Compatível com discos 6 parafusos
- Freehub padrão XD
- Material Alumínio

**RAIO**

- Importado
- Sapin laser
- Inox

**PESO**

- Roda dianteira 720 gr
- Roda traseira 880 gr
- Par 1.600GR

**EMBALAGEM** 01 kit

22837

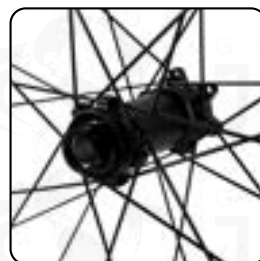

QUEST

## RODA D/T. 29X28F 6P. CARBON MOD. 02 BOOST HG/MS PT IMP.

**MATERIAL** \_\_\_\_\_ Carbono

**ARO** \_\_\_\_\_

- Quest Carbon Race Q30 29"
- 30mm de largura interna
- Tecnologia Hookless, sem ganchos laterais internos
- Tubeless
- 28 furos

**CUBO DIANTEIRO** \_\_\_\_\_

- Material alumínio
- Boost eixo 15x110mm
- Compatível com discos 6 parafusos
- 28 Furos

**CUBO TRASEIRO** \_\_\_\_\_

- Material alumínio
- Boost
- Eixo 12x148mm
- Compatível com discos 6 parafusos
- Freehub padrão MICRO SPLINE e HG inclusos

**RAIO** \_\_\_\_\_

- Importado
- Sapin laser
- Inox

**PESO** \_\_\_\_\_

- Dianteiro 720 gr
- Traseiro MS 890 gr
- Traseiro HG 930 gr
- Par 1.610kg/1.650kg

**EMBALAGEM** \_\_\_\_\_ 01 kit

22839

FOTOS MERAMENTE ILUSTRATIVAS. AS INFORMAÇÕES/CONFIGURAÇÕES DE PRODUTOS PODERÃO SOFRER ALTERAÇÕES SEM AVISO PRÉVIO.

ENTRE EM CONTATO COM O SEU CONSULTOR OU FALE COM O NOSSO TIME DE TELEVENDAS PELO (33) 3277-3030.



## RODA D/T. 29X28F 6P. CARBON SL MOD. 03 BOOST XD PT IMP.

**MATERIAL** Carbono

**ARO**

- Quest Carbon Race Q30 SL SUPER LIGHT 29"
- 30mm de largura interna
- Tecnologia Hookless, sem ganchos laterais internos
- Tubeless
- 28 furos

**CUBO DIANTEIRO**

- Material alumínio
- Boost eixo 15x110mm
- Compatível com discos 6 parafusos
- 28 Furos

**CUBO TRASEIRO**

- Boost
- Eixo 12x148mm
- Compatível com discos 6 parafusos
- Freehub padrão XD
- Material Alumínio

**RAIO**

- Importado
- Sapin CX RAY
- Inox aero

**PESO**

- Roda dianteira 630 gr
- Roda traseira 790 gr
- Par 1420gr

**EMBALAGEM** 01 kit

22840

FOTOS MERAMENTE ILUSTRATIVAS. AS INFORMAÇÕES/CONFIGURAÇÕES DE PRODUTOS PODERÃO SOFRER ALTERAÇÕES SEM AVISO PRÉVIO.

ENTRE EM CONTATO COM O SEU CONSULTOR OU FALE COM O NOSSO TIME DE TELEVENDAS PELO (33) 3277-3030.

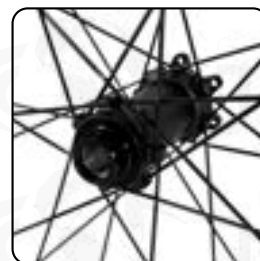

## RODA D/T. 29X28F 6P. CARBON SL MOD. 04 BOOST HG/MS PT IMP.

**MATERIAL** Carbono

**ARO**

- Quest Carbon Race Q30 SL Super Light 29"
- 30mm de largura interna
- Tecnologia Hookless, sem ganchos laterais internos
- Tubeless
- 28 furos

**CUBO DIANTEIRO**

- Material alumínio
- Boost eixo 15x110mm
- Compatível com discos 6 parafusos
- 28 Furos

**CUBO TRASEIRO**

- Material alumínio
- Boost
- Eixo 12x148mm
- Compatível com discos 6 parafusos
- Freehub padrão MICRO SPLINE e HG inclusos

**RAIO**

- Importado
- Sapin CX RAY
- Inox aero

**PESO**

- Dianteiro 630 gr
- Traseiro MS 790 gr
- Traseiro HG 820 gr
- Par 1.420kg/1.450kg

**EMBALAGEM** 01 kit

22847

FOTOS MERAMENTE ILUSTRATIVAS. AS INFORMAÇÕES/CONFIGURAÇÕES DE PRODUTOS PODERÃO SOFRER ALTERAÇÕES SEM AVISO PRÉVIO.

ENTRE EM CONTATO COM O SEU CONSULTOR OU FALE COM O NOSSO TIME DE TELEVENDAS PELO (33) 3277-3030.



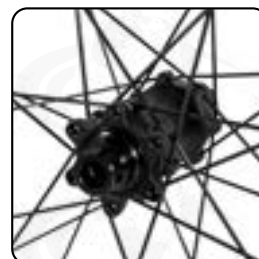
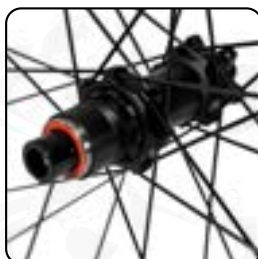

## RODA D/T. 29X28F 6P. ALUM MOD. 11 BOOST XD PT NAC.

**MATERIAL** Alumínio

**RAIO** • Inox  
• Importado

**ARO**

- WTB KOM I30 LIGHT 29"
- 30mm de largura interna
- Tubeless
- 28 furos
- ERD 606mm
- Largura do pneu 42mm - 72mm

**PESO**

- Roda dianteira 890 gr
- Roda traseira 1030 gr
- Par 1.920gr

**CUBO DIANTEIRO**

- Material alumínio
- Boost
- Eixo 15x110mm
- Compatível com discos 6 parafusos
- 28 Furos

**EMBALAGEM** 01kit

22848

**CUBO TRASEIRO**

- Boost
- Eixo 12x148mm
- Compatível com discos 6 parafusos
- Freehub padrão XD
- Material Alumínio

FOTOS MERAMENTE ILUSTRATIVAS. AS INFORMAÇÕES/CONFIGURAÇÕES DE PRODUTOS PODERÃO SOFRER ALTERAÇÕES SEM AVISO PRÉVIO.

ENTRE EM CONTATO COM O SEU CONSULTOR OU FALE COM O NOSSO TIME DE TELEVENDAS PELO (33) 3277-3030.



## RODA D/T. 29X28F 6P. ALUM MOD. 12 BOOST XD PT NAC.

**MATERIAL** Alumínio

**ARO**

- WTB KOM I30 TEAM 29"
- 30mm de largura interna
- Tubeless
- 28 furos
- ERD 606mm
- Largura do pneu 42mm - 72mm

**CUBO DIANTEIRO**

- Material alumínio
- Boost 110x15
- Compatível com discos 6 parafusos
- 28 Furos

**CUBO TRASEIRO**

- Material alumínio
- Boost 148x12
- Compatível com discos 6 parafusos
- Freehub padrão XD

**RAIO**

- Importado
- Inox

**PESO**

- Dianteiro 940 gr
- Traseiro 1080 gr
- Par 2.020 kg

**EMBALAGEM** 01 kit

22849

FOTOS MERAMENTE ILUSTRATIVAS. AS INFORMAÇÕES/CONFIGURAÇÕES DE PRODUTOS PODERÃO SOFRER ALTERAÇÕES SEM AVISO PRÉVIO.

ENTRE EM CONTATO COM O SEU CONSULTOR OU FALE COM O NOSSO TIME DE TELEVENDAS PELO (33) 3277-3030.

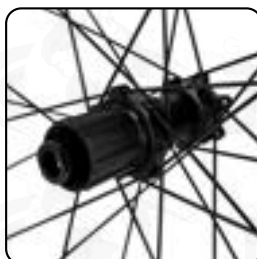

## RODA D/T. 29X28F 6P. ALUM MOD. 13 BOOST HG/MS PT NAC.

**MATERIAL** Alumínio

**ARO**

- WTB KOM I30 LIGHT 29"
- 30mm de largura interna
- Tubeless
- 28 furos
- ERD 606mm
- Largura do pneu 42mm - 72mm

**CUBO DIANTEIRO**

- Material alumínio
- Boost
- Eixo 15x110mm
- Compatível com discos 6 parafusos
- 28 Furos

**CUBO TRASEIRO**

- Boost
- Eixo 12x148mm
- Compatível com discos 6 parafusos
- Freehub padrão MICRO SPLINE e HG inclusos
- Material Alumínio

**RAIO**

- Inox
- Importado

**PESO**

- Roda dianteira 850 gr
- Roda traseira HG 1.110gr
- Par 1.930/1.960KG

**EMBALAGEM** 01kit

22850



## RODA D/T. 29X28F 6P. ALUM MOD. 14 BOOST HG/MS PT NAC.

**MATERIAL** Alumínio

**ARO**

- WTB KOM I30 TEAM 29"
- 30mm de largura interna
- Tubeless
- 28 furos
- ERD 606mm
- Largura do pneu 42mm - 72mm

**CUBO DIANTEIRO**

- Material alumínio
- Boost
- Eixo 15x110mm
- Compatível com discos 6 parafusos
- 28 Furos

**CUBO TRASEIRO**

- Material alumínio
- Boost
- Eixo 12x148mm
- Compatível com discos 6 parafusos
- Freehub padrão MICRO SPLINE e HG inclusos

**RAIO**

- Importado
- Inox

**PESO**

- Dianteiro 860 gr
- Traseiro MS 1080 gr
- Traseiro HG 1110 gr
- Par 1.940kg/1.970kg

**EMBALAGEM** 01kit

22851

FOTOS MERAMENTE ILUSTRATIVAS. AS INFORMAÇÕES/CONFIGURAÇÕES DE PRODUTOS PODERÃO SOFRER ALTERAÇÕES SEM AVISO PRÉVIO.

ENTRE EM CONTATO COM O SEU CONSULTOR OU FALE COM O NOSSO TIME DE TELEVENDAS PELO (33) 3277-3030.



## RODA D/T. 29X28F CL. ALUM MOD. 15 BOOST HG/MS PT NAC.

**MATERIAL** Alumínio

**RAIO** • Inox  
• Importado

**ARO**

- WTB KOM I30 LIGHT 29"
- 30mm de largura interna
- Tubeless
- 28 furos
- ERD 606mm
- Largura do pneu 42mm - 72mm

**PESO**

- Roda dianteira 850 gr
- Roda traseira MS 1030 gr
- Traseiro HG 1060 gr
- Par 1.880/1.910 kg

**CUBO DIANTEIRO**

- Material alumínio
- Boost
- Eixo 15x110mm
- Compatível com discos Center Lock
- 28 Furos

**EMBALAGEM** 01 kit

22852

**CUBO TRASEIRO**

- Boost eixo 12x148mm
- Compatível com discos Center Lock
- Freehub padrão MICRO SPLINE e HG inclusos
- Material Alumínio

FOTOS MERAMENTE ILUSTRATIVAS. AS INFORMAÇÕES/CONFIGURAÇÕES DE PRODUTOS PODERÃO SOFRER ALTERAÇÕES SEM AVISO PRÉVIO.

ENTRE EM CONTATO COM O SEU CONSULTOR OU FALE COM O NOSSO TIME DE TELEVENDAS PELO (33) 3277-3030.

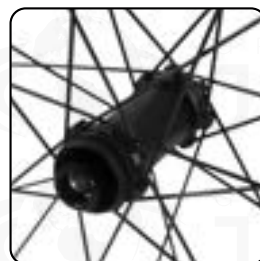

QUEST

## RODA D/T. 29X28F 6P. ALUM MOD. 14 BOOST HG/MS PT NAC.

**MATERIAL** Alumínio

**ARO**

- WTB KOM I30 TEAM 29"
- 30mm de largura interna
- Tubeless
- 28 furos
- ERD 606mm
- Largura do pneu 42mm - 72mm

**CUBO DIANTEIRO**

- Material alumínio
- Boost
- Eixo 15x110mm
- Compatível com discos 6 parafusos
- 28 Furos

**CUBO TRASEIRO**

- Material alumínio
- Boost
- Eixo 12x148mm
- Compatível com discos 6 parafusos
- Freehub padrão MICRO SPLINE e HG inclusos

**RAIO**

- Importado
- Inox

**PESO**

- Dianteiro 870 gr
- Traseiro MS 1.090 gr
- Traseiro HG 1.120 gr
- Par 1.990kg/1.960kg

**EMBALAGEM** 01kit

22853

FOTOS MERAMENTE ILUSTRATIVAS. AS INFORMAÇÕES/CONFIGURAÇÕES DE PRODUTOS PODERÃO SOFRER ALTERAÇÕES SEM AVISO PRÉVIO.

ENTRE EM CONTATO COM O SEU CONSULTOR OU FALE COM O NOSSO TIME DE TELEVENDAS PELO (33) 3277-3030.

## CUBO D/T ALUM 28F 6P. CASSETE SPEED SH

**CUBO DIANTEIRO** Eixo 12x100mm  
Eixo interno de alumínio  
OLD 100mm  
28 furos  
02 rolamentos (medida 16287RS)  
Compatível com disco de seis parafusos

**CUBO TRASEIRO** Eixo 12x142mm  
Eixo interno de alumínio  
28 furos  
02 rolamentos (medida 16287-RS)  
02 rolamentos freehub (medidas 6902-2RS)  
Freehub padrão HG com 6 martelinhos  
Compatível com disco de seis parafusos

**MATERIAL** Alumínio

**PESO** 460gr - peso referente ao par

22925



## CUBO D/T ALUM 28F 6P. CASSETE SPEED XD

**CUBO DIANTEIRO** Eixo 12x100mm  
Eixo interno de alumínio  
OLD 100mm  
28 furos  
02 rolamentos (medida 16287RS)  
Compatível com disco de seis parafusos

**CUBO TRASEIRO** Eixo 12x142mm  
Eixo interno de alumínio  
28 furos  
02 rolamentos (medida 16287-RS)  
02 rolamentos freehub (medidas 6902-2RS)  
Freehub padrão XD com 6 martelinhos  
Compatível com disco de seis parafusos

**MATERIAL** Alumínio

**PESO** 460gr - peso referente ao par

22924



## CUBO D/T 32HX15X110/12X148MM BOOST MS PT | LINHA QUEST

**CARACTERÍSTICA** Par de cubo boost | linha quest

- Cubo dianteiro:
- Material alumínio
  - Boost
  - Eixo 15x110mm
  - Eixo interno de alumínio
  - Old 110mm
  - 32 Furos
  - 02 Rolamentos (medida 6804rs)
  - Compatível com freio a disco 6 parafusos

- 
- Cubo traseiro:
- Material alumínio
  - Boost
  - Eixo 12x148mm
  - Eixo interno de alumínio
  - 32 Furos
  - 02 Rolamentos (medida 6902-2rs)
  - 02 Rolamentos freehub (medidas 6802-2rs)
  - Freehub padrão micro spline com 6 martelinhos
  - Compatível com freio a disco 6 parafusos

**MATERIAL** Alumínio

**PESO** 476gr - peso referente ao par

**EMBALAGEM** 10 peças

22746



QUEST

## CUBO BOOST | LINHA QUEST

**CARACTERÍSTICA** Cubo Dianteiro: Alumínio Boost | Eixo de 15 mm | OLD 110 mm | 32 furos com rolamentos  
Cubo Traseiro: Alumínio Boost | OLD 148 mm | Eixo de 12 mm | 32 furos com rolamentos | Cassete XD System | Preto.

**MATERIAL** Alumínio

**PESO** 470 gr (Par)

**EMBALAGEM** 10 peças

20576





## EIXO E FREEHUB PARA CUBO QUEST MICRO SPLINE

**CARACTERÍSTICA** Eixo boost 12x148  
Compatível com cubo Quest cód  
22746  
Freehub Micro Spline  
Contém dois rolamentos e  
terminais de eixo

24965



## EIXO E FREEHUB PARA CUBO FORMULA XD

**CARACTERÍSTICA** Eixo boost 12x148  
Compatível com cubo Quest cód  
20576  
Freehub XD  
Contém dois rolamentos e  
terminais de eixo

24966



FOTOS MERAMENTE ILUSTRATIVAS. AS INFORMAÇÕES/CONFIGURAÇÕES DE PRODUTOS PODERÃO SOFRER ALTERAÇÕES SEM AVISO PRÉVIO.

ENTRE EM CONTATO COM O SEU CONSULTOR OU FALE COM O NOSSO TIME DE TELEVENDAS PELO (33) 3277-3030.

## SUPORE CARAMANHOLA CARBONO | LINHA QUEST

<b>CARACTERÍSTICA</b>	Carbono Design Moderno Leve e Resistente
<b>MATERIAL</b>	Carbono
<b>FIXAÇÃO</b>	2 Parafusos (não acompanham suporte)
<b>PESO</b>	35g
<b>EMBALAGEM</b>	50 peças
	22248



## SUPORE CARAMANHOLA MOD.2 CRB | LINHA QUEST

<b>CARACTERÍSTICA</b>	• Suporte caramanhola • Fixação por dois parafusos (não acompanham o suporte)
<b>MATERIAL</b>	Carbono (UD Matt Carbon Fiber t800)
<b>TAMANHO</b>	• Medidas 14 x 7.2mm
<b>REMOÇÃO DA GARRAFA</b>	• Remoção da garrafa standard
<b>PESO</b>	20g
<b>EMBALAGEM</b>	25 peças
	22249



QUEST

## EIXO DIANTEIRO BOOST 15 X 110 MM | LINHA QUEST

<b>CARACTERÍSTICA</b>	Eixo Alumínio 15mm Boost com porca   Corpo Alumínio maciço Diâmetro da bitola 21.5mm Largura da bitola 5mm Allen 6mm Comprimento do corpo 136mm Comprimento da rosca 20mm Comprimento total 161.5mm
<b>MATERIAL</b>	Alumínio
<b>PESO</b>	80Gr - incluindo a porca
<b>EMBALAGEM</b>	20 peças
	20834



FOTOS MERAMENTE ILUSTRATIVAS. AS INFORMAÇÕES/CONFIGURAÇÕES DE PRODUTOS PODERÃO SOFRER ALTERAÇÕES SEM AVISO PRÉVIO.

ENTRE EM CONTATO COM O SEU CONSULTOR OU FALE COM O NOSSO TIME DE TELEVENDAS PELO (33) 3277-3030.

## PROTECTOR CABEAMENTO INTERNO 1,5MT | LINHA QUEST

**CARACTERÍSTICA** - Comprimento 1.5m  
- Diâmetro externo 12mm  
- Diâmetro interno 6mm

**MATERIAL** EVA

**PESO** 64Gr

**EMBALAGEM** 50 peças

23832



## CARTUCHO INTERNO SUSPENSÃO | LINHA QUEST

**CARACTERÍSTICA** Cartucho interno para suspensão Quest: | Corpo em Aço  
Porca do acionador na trava em alumínio | Acompanha parafuso inferior para fixação na lower leg | Comprimento total do eixo 580mm

**MATERIAL** Alumínio/ Aço

**PESO** 247Gr

**EMBALAGEM** 20 peças

20832



## REPARO INTERNO SUSPENSÃO | LINHA QUEST

**CARACTERÍSTICA** Kit de reparo da câmara de AR para suspensão Quest: | Kit acompanha 3 peças (Porca com válvula da câmara de ar/ Válvula interna / Eixo com molas e batentes) | Corpo do eixo em Alumínio | Válvula interna em alumínio | Porca com válvula em alumínio | Bitola do eixo - Allen 6mm | Comprimento total do eixo 250mm

**MATERIAL** Alumínio

**PESO** 137Gr - Kit completo

**EMBALAGEM** 20 peças

20833



FOTOS MERAMENTE ILUSTRATIVAS. AS INFORMAÇÕES/CONFIGURAÇÕES DE PRODUTOS PODERÃO SOFRER ALTERAÇÕES SEM AVISO PRÉVIO.

ENTRE EM CONTATO COM O SEU CONSULTOR OU FALE COM O NOSSO TIME DE TELEVENDAS PELO (33) 3277-3030.

## CANOTE SELIM ALUMÍNIO C/ REMOTE K PT | LINHA QUEST

**CARACTERÍSTICA** Trava remota mecânico | Cabeamento interno  
Profundidade de inserção: 90mm  
Fixação do selim: 2 parafusos  
Alavanca com acionamento vertical

**MATERIAL** Alumínio

**TAMANHO** Diâmetro do canote: 31.6 mm

**PESO** 621g (canote + conduíte com cabo + alavanca)

**CÓDIGO:** 24346 - 31.6X295X75MM

24347 - 31.6X345X100MM

24348 - 31.6X395X125MM

24349 - 31.6X445X150MM



QUEST

## EIXO DIANTEIRO BOOST 15X110MM | LINHA QUEST

**CARACTERÍSTICA**

- Eixo dianteiro boost
- Marca quest
- Material alumínio
- Eixo 15x110mm
- Rosca do eixo 1.5mm
- Comprimento do corpo 142mm
- Comprimento da rosca 22mm
- Comprimento total 147mm
- Diâmetro da bitola 22mm
- Largura do bitola 5mm
- Bitola allen 6mm

**MATERIAL** Alumínio

**PESO** +-64gr

**EMBALAGEM** 20 peças

23230



FOTOS MERAMENTE ILUSTRATIVAS. AS INFORMAÇÕES/CONFIGURAÇÕES DE PRODUTOS PODERÃO SOFRER ALTERAÇÕES SEM AVISO PRÉVIO.

ENTRE EM CONTATO COM O SEU CONSULTOR OU FALE COM O NOSSO TIME DE TELEVENDAS PELO (33) 3277-3030.

## CANOTE SELIM ALUMÍNIO C/ REMOTE W PT | LINHA QUEST

**CARACTERÍSTICA** Trava remota mecânico | Cabeamento interno  
Profundidade de inserção: 80mm  
Fixação do selim: 2 parafusos.  
Alavanca com acionamento horizontal.

**MATERIAL** Alumínio

**TAMANHO** Diâmetro do canote: 31.6 mm

**PESO** 601g (canote + conduíte com cabo + alavanca)

**CÓDIGO:** 24350 – 31.6X295X75MM

= 24351 – 31.6X345X100MM

24352 – 31.6X395X125MM

24353 – 31.6X445X150MM



## EIXO DIANTEIRO BOOST 15X110MM C/BLOC | LINHA QUEST

**CARACTERÍSTICA**

- Eixo dianteiro boost com blocagem
- Marca quest
- Material alumínio
- Eixo 15x110mm
- Rosca do eixo 1.5mm
- Comprimento do corpo 142mm
- Comprimento da rosca 22mm
- Comprimento total 167.2mm
- Sistema de instação por blocagem
- Blocagem com regulagem de posição

**MATERIAL** Alumínio

**PESO** +-77gr

**EMBALAGEM** 20 peças

23231



FOTOS MERAMENTE ILUSTRATIVAS. AS INFORMAÇÕES/CONFIGURAÇÕES DE PRODUTOS PODERÃO SOFRER ALTERAÇÕES SEM AVISO PRÉVIO.

ENTRE EM CONTATO COM O SEU CONSULTOR OU FALE COM O NOSSO TIME DE TELEVENDAS PELO (33) 3277-3030.

# PROMEND

C A T Á L O G O





### MANOPLA PROMEND | GR-515

<b>MODELO</b>	GR-515
<b>CARACTERÍSTICA</b>	Anel de alumínio (2x)   Trava (2x) e tampa
<b>MATERIAL</b>	PU+PP+EVA+ALLOY
<b>TAMANHO</b>	130 x 28 mm (Guidão de 22.2 mm)
<b>PESO</b>	88g
<b>EMBALAGEM</b>	100 peças

16215



### MANOPLA PROMEND | GR-513

<b>MODELO</b>	GR-513
<b>CARACTERÍSTICA</b>	Anel de alumínio   Trava e tampa
<b>MATERIAL</b>	Espuma / ABS
<b>TAMANHO</b>	126 x 34 mm (Guidão de 22.2 mm)
<b>PESO</b>	98g
<b>EMBALAGEM</b>	100 peças

16216



### MANOPLA PROMEND | GR-504

<b>MODELO</b>	GR-504
<b>CARACTERÍSTICA</b>	Anel de alumínio (2x), trava (2x) e tampa
<b>MATERIAL</b>	Borracha / Plástico
<b>TAMANHO</b>	135 x 55 x 35 mm (Guidão de 22.2 mm)
<b>PESO</b>	180g
<b>EMBALAGEM</b>	100 peças

16217



### FITA DE GUIDÃO PROMEND | GH-081H

<b>MODELO</b>	GH-081H
<b>MODALIDADE</b>	Road bike
<b>MATERIAL</b>	EVA
<b>ACABAMENTO</b>	Plugs de fechamento
<b>TAMANHO</b>	2000 x 30 mm
<b>PESO</b>	57g
<b>EMBALAGEM</b>	10 peças

16218

## PEDAL CLIP MTB | PD-M96

<b>MODELO</b>	PD-M96
<b>CARACTERÍSTICA</b>	Pedal com rolamento
<b>MATERIAL</b>	Alumínio / Chromoly
<b>TACO</b>	MTB SPD
<b>TAMANHO</b>	105 * 80 * 34.5mm
<b>PESO</b>	340g (par)
<b>EMBALAGEM</b>	1 conjunto
	11777

FOTO ILUSTRATIVA  
DA EMBALAGEM



## PEDAL CLIP SPEED | PD-R97

<b>MODELO</b>	PD-R97
<b>CARACTERÍSTICA</b>	Pedal com rolamento
<b>MATERIAL</b>	Alumínio / Chromoly
<b>TACO</b>	Speed SPD
<b>PESO</b>	298g (par)
<b>EMBALAGEM</b>	1 conjunto
	11778

FOTO ILUSTRATIVA  
DA EMBALAGEM



**promendo**



## PEDAL CLIP SPEED | PD-R95

<b>MODELO</b>	PD-R95
<b>CARACTERÍSTICA</b>	Pedal com rolamento
<b>MATERIAL</b>	Alumínio / Chromoly
<b>TACO</b>	Speed LOOK
<b>PESO</b>	310g (par)
<b>EMBALAGEM</b>	1 conjunto 11779



FOTO ILUSTRATIVA  
DA EMBALAGEM



## TACO SPEED SPD

<b>COMPATIBILIDADE</b>	Speed SPD
<b>EMBALAGEM</b>	10 peças 11782



## TACO SPEED LOOK

<b>COMPATIBILIDADE</b>	Speed LOOK
<b>EMBALAGEM</b>	10 peças 11783

FOTOS MERAMENTE ILUSTRATIVAS. AS INFORMAÇÕES/CONFIGURAÇÕES DE PRODUTOS PODERÃO SOFRER ALTERAÇÕES SEM AVISO PRÉVIO.

ENTRE EM CONTATO COM O SEU CONSULTOR OU FALE COM O NOSSO TIME DE TELEVENDAS PELO (33) 3277-3030.

## TACO MTB SPD

**COMPATIBILIDADE** MTB SPD

**EMBALAGEM** 10 peças

11784



## TACO SPEED SPD

**CARACTERÍSTICA** Tacos para pedais de ciclismo de Estrada | Possui parafusos e chave para instalação

Desenhados para pedais Speed (modelo compatível com Shimano)

Dimensões do Produto:  
Float (flutuação): 6 graus  
Altura : 2,5 cm  
Largura: 8 cm  
Comprimento: 7 cm  
Peso: 90 gramas

Contém: 2 tacos, 6 parafusos, 6 arruelas e 1 chave allen 4mm

**COMPATIBILIDADE** Compatível com demais fabricantes que utilizam o sistema SPD

**EMBALAGEM** 10 peças

22697



### PEDAL MTB | PD-M86C

<b>MODELO</b>	PD-M86C
<b>CARACTERÍSTICA</b>	Três rolamentos
<b>MATERIAL</b>	Alumínio / carbono
<b>EIXO</b>	9/16"
<b>TAMANHO</b>	109 * 93,5 * 12mm
<b>PESO</b>	281g (par)
<b>EMBALAGEM</b>	10 peças
	11781



### PEDAL MTB | PD-M29

<b>MODELO</b>	PD-M29
<b>MATERIAL</b>	Alumínio / Chromoly
<b>EIXO</b>	9/16"
<b>TAMANHO</b>	123 * 100 * 18mm
<b>PESO</b>	319g (par)
<b>EMBALAGEM</b>	10 peças
	11780



### PEDAL PROMEND | PD-R67

<b>MODELO</b>	PD-R67   Rolamento (3x) selado
<b>MATERIAL</b>	Alumínio (corpo) / CR-MO (eixo)
<b>EIXO</b>	9/16"
<b>TAMANHO</b>	105 x 91 x 18 mm
<b>PESO</b>	270g (par)
<b>EMBALAGEM</b>	10 peças
	16221



### PEDAL PROMEND | PD-M28

<b>MODELO</b>	PD-M28
<b>MATERIAL</b>	Alumínio (corpo) / DU (eixo)
<b>EIXO</b>	9/16"
<b>TAMANHO</b>	130 x 105 x 16 mm
<b>PESO</b>	363g (par)
<b>EMBALAGEM</b>	10 peças
	16222

FOTOS MERAMENTE ILUSTRATIVAS. AS INFORMAÇÕES/CONFIGURAÇÕES DE PRODUTOS PODERÃO SOFRER ALTERAÇÕES SEM AVISO PRÉVIO.

ENTRE EM CONTATO COM O SEU CONSULTOR OU FALE COM O NOSSO TIME DE TELEVENDAS PELO (33) 3277-3030.



**PEDAL MTB CLIP PLAT. PRETO**  
**PD-F91 MOD. 01**

<b>MODELO</b>	PD-F91
<b>CARACTERÍSTICA</b>	<ul style="list-style-type: none"> <li>• Rolamento selado</li> <li>• Clip e Plataforma de Nylon</li> <li>• Taco padrão Shimano (acompanha o pedal)</li> <li>• Ajuste de tensão</li> <li>• MTB</li> </ul>
<b>MATERIAL</b>	Aço, Alumínio e Nylon
<b>EIXO</b>	9/16"
<b>TAMANHO</b>	83 x 71 x 19,3 mm
<b>PESO</b>	300g (par)
<b>EMBALAGEM</b>	10 peças
	23577



**PEDAL MTB CLIP PLAT. PRETO**  
**PD-F91L MOD. 02**

<b>MODELO</b>	PD-F91L
<b>CARACTERÍSTICA</b>	<ul style="list-style-type: none"> <li>• Rolamento selado</li> <li>• Clip e Plataforma de Nylon</li> <li>• Taco padrão Shimano (acompanha o pedal)</li> <li>• Ajuste de tensão</li> <li>• MTB</li> </ul>
<b>MATERIAL</b>	Aço, Alumínio e Nylon
<b>EIXO</b>	9/16"
<b>TAMANHO</b>	100 x 88.6 x 21 mm
<b>PESO</b>	360g (par)
<b>EMBALAGEM</b>	10 peças
	23578

**PEDAL MTB ALUM. CLIP**  
**PRETO PD-M96P MOD. 02**

<b>MODELO</b>	PD-M96P
<b>CARACTERÍSTICA</b>	<ul style="list-style-type: none"> <li>• Pedal Clip</li> <li>• Rolamento selado</li> <li>• Clip dupla face</li> <li>• Corpo de Nylon</li> <li>• Taco padrão Shimano (acompanha o pedal)</li> <li>• Ajuste de tensão</li> <li>• MTB</li> </ul>
<b>MATERIAL</b>	Aço, Alumínio e Nylon
<b>EIXO</b>	9/16"
<b>TAMANHO</b>	-
<b>PESO</b>	332g (par)
<b>EMBALAGEM</b>	10 peças
	23582



**promendo**

**PEDAL MTB ALUM. CLIP**  
**PRETO PD-M96B MOD. 03**

**MODELO** PD-M96B

- CARACTERÍSTICA**
- Pedal Clip
  - Rolamento selado
  - Clip dupla face
  - Corpo de Alumínio
  - Taco padrão Shimano (acompanha o pedal)
  - Ajuste de tensão
  - MTB

**MATERIAL** Aço e Alumínio

**EIXO** 9/16"

**TAMANHO** 83 x 71 x 19,3 mm

**PESO** 373g (par)

**EMBALAGEM** 10 peças

23583



**PEDAL MTB ALUM. PD-M24N**  
**MOD. 04 PRETO**

**MODELO** PD-M24N

- CARACTERÍSTICA**
- MTB
  - Acompanha chave allen 6mm
  - Bucha de nylon

**MATERIAL** Alumínio

**EIXO** 9/16"

**TAMANHO** 104 x 102 x 14 mm

**PESO** 380g

**EMBALAGEM** 10 peças

24700





## PLATAFORMA DE PROTEÇÃO DO TAQUINHO PEDAL CLIP MOD.01

**MATERIAL**

- Plataforma de Nylon
- Plataforma para taquinho Speed
- Padrão Shimano (SPD)

**TAMANHO** 95 x 67 x 14 mm

**PESO** 56g

**EMBALAGEM** 25 peças

23579



## PLATAFORMA PARA PEDAL CLIP MOD.02

**MATERIAL**

- Plataforma de Nylon
- Plataforma para Pedal Speed
- Padrão Shimano (SPD)

**TAMANHO** 73 x 64 x 21 mm

**PESO** 48g

**EMBALAGEM** 25 peças

23580



## SELIM MTB CROMOLY

**MODELO** SD 576

**CARACTERÍSTICA** Trilho de Cromoly | Vazado

**TAMANHO** 250\*160 mm | 250\*142 mm

**PESO** 260g

**EMBALAGEM** 10 peças

**160MM** 11787

**142MM** 13878



## SELIM MTB CARBON RACE

**MODELO** SD 576-C

**CARACTERÍSTICA** Trilho de carbono | Vazado

**TAMANHO** 250\*150MM

**TORQUE NM** 2-4N

**LIMITE DE PESO** 80 kg

**PESO** 151g

**EMBALAGEM** 10 peças

11788



### SELIM MTB CROMOLY VAZADO EXPERT

<b>MODELO</b>	SD 573
<b>CARACTERÍSTICA</b>	Trilho de titânio   Vazado
<b>TAMANHO</b>	270 * 145mm
<b>PESO</b>	232g
<b>EMBALAGEM</b>	10 peças
	11789



### SELIM MTB VAZADO MODELO 07

<b>MATERIAL</b>	Plástico
<b>TRILHO</b>	Trilho de aço
<b>TAMANHO</b>	285x140 mm
<b>PESO</b>	180g
<b>EMBALAGEM</b>	70 peças
	12490



### SELIM MTB VAZADO MODELO 08

<b>REVESTIMENTO</b>	PU
<b>TRILHO</b>	Trilho de aço
<b>TAMANHO</b>	285x140 mm
<b>PESO</b>	260g
<b>EMBALAGEM</b>	50 peças
	12491

FOTOS MERAMENTE ILUSTRATIVAS. AS INFORMAÇÕES/CONFIGURAÇÕES DE PRODUTOS PODERÃO SOFRER ALTERAÇÕES SEM AVISO PRÉVIO.

ENTRE EM CONTATO COM O SEU CONSULTOR OU FALE COM O NOSSO TIME DE TELEVENDAS PELO (33) 3277-3030.

Promendo



### SELIM MTB VAZADO MODELO 13

<b>MATERIAL</b>	PU   Espuma de poliuretano
<b>TRILHO</b>	CR-MO
<b>TAMANHO</b>	255 x 140 mm
<b>PESO</b>	305g
<b>EMBALAGEM</b>	16 peças
	16225



### SELIM MTB VAZADO MODELO 14

<b>MATERIAL</b>	PU / Espuma de poliuretano
<b>TRILHO</b>	Aço
<b>TAMANHO</b>	245 x 160 mm
<b>PESO</b>	305g
<b>EMBALAGEM</b>	16 peças
	16226



### SELIM PASSEIO GEL MODELO 09

<b>REVESTIMENTO</b>	PU
<b>TRILHO</b>	Trilho de aço
<b>TAMANHO</b>	265x230 mm
<b>PESO</b>	920g
<b>EMBALAGEM</b>	15 peças
	12993

FOTOS MERAMENTE ILUSTRATIVAS. AS INFORMAÇÕES/CONFIGURAÇÕES DE PRODUTOS PODERÃO SOFRER ALTERAÇÕES SEM AVISO PRÉVIO.

ENTRE EM CONTATO COM O SEU CONSULTOR OU FALE COM O NOSSO TIME DE TELEVENDAS PELO (33) 3277-3030.



## SELIM PASSEIO EXTRA BIG MODELO 10

REVESTIMENTO	PU
TRILHO	Trilho de aço
TAMANHO	310x275 mm
PESO	990g
EMBALAGEM	16 peças
	12994



## SELIM MTB VAZADO MODELO 11

MATERIAL	PU   Fibra Mirosoft   Enchimento de EVA
MODELO	SD-576B
TRILHO	Aço
TAMANHO	245 x 155 mm
PESO	306g
EMBALAGEM	16 peças
	16223



FOTOS MERAMENTE ILUSTRATIVAS. AS INFORMAÇÕES/CONFIGURAÇÕES DE PRODUTOS PODERÃO SOFRER ALTERAÇÕES SEM AVISO PRÉVIO.

ENTRE EM CONTATO COM O SEU CONSULTOR OU FALE COM O NOSSO TIME DE TELEVENDAS PELO (33) 3277-3030.

## SELIM MTB PRETO VAZADO MOD.12

### CARACTERÍSTICAS

- Selim mtb vazado com gel
- Ergonômico
- Absorção de choque através do gel
- Ótima ventilação
- Confortável
- Base em polipropileno de alta resistência
- Espuma
- Capa laminada em pvc

### MATERIAL

Polipropileno / espuma

### TAMANHO

Medida 270 x 170mm

### PESO

463g

### EMBALAGEM

25 peças

23576



## SELIM MTB PRETO MOD.15

### CARACTERÍSTICAS

Selim mtb | linha promend

- Selim mtb
- Ergonômico
- Confortável
- Base em polipropileno de alta resistência
- Espuma
- Capa laminada em pvc

### MATERIAL

Polipropileno / espuma

### TAMANHO

Medida 275 x 137mm

### PESO

333g

### EMBALAGEM

25 peças

23587



## SELIM MTB PRETO VAZADO MOD.16

### CARACTERÍSTICAS

- Selim mtb vazado
- Ergonômico
- Ótima ventilação
- Confortável
- Base em polipropileno de alta resistência
- Espuma
- Capa laminada em pvc

### MATERIAL

Polipropileno / espuma

### TAMANHO

Medida 280 x 140mm

### PESO

358g

### EMBALAGEM

25 peças

23588



## SELIM MTB PRETO VAZADO MOD.17

### CARACTERÍSTICAS

- Selim mtb vazado
- Ergonômico
- Ótima ventilação
- Confortável
- Base em polipropileno de alta resistência
- Espuma
- Capa laminada em pvc

### MATERIAL

Polipropileno / espuma

### TAMANHO

Medida 270 x 158mm

### PESO

353g

### EMBALAGEM

25 peças

23589



FOTOS MERAMENTE ILUSTRATIVAS. AS INFORMAÇÕES/CONFIGURAÇÕES DE PRODUTOS PODERÃO SOFRER ALTERAÇÕES SEM AVISO PRÉVIO.

ENTRE EM CONTATO COM O SEU CONSULTOR OU FALE COM O NOSSO TIME DE TELEVENDAS PELO (33) 3277-3030.

## SELIM MTB PRETO VAZADO MOD.18

### CARACTERÍSTICAS

- Selim mtb vazado
- Ergonômico
- Trilho de aço
- Ótima ventilação
- Confortável
- Base em TPU de alta resistência
- Assento emborrachado

### MATERIAL

Poliuretano termoplástico e aço

### TAMANHO

149mm x 260mm

### PESO

342g

### EMBALAGEM

25 peças

24699



## SELIM MTB PRETO VAZADO MOD.20

### CARACTERÍSTICAS

- Selim mtb vazado
- Ergonômico
- Trilho de aço
- Ótima ventilação
- Confortável
- Excelente acabamento
- Base em PU de alta resistência
- Assento em espuma
- Mola em elastrômero

### MATERIAL

Poliuretano e aço

### PESO

602g

### EMBALAGEM

25 peças

24721



PROMENHO

## SELIM MTB PRETO VAZADO MOD.21

### CARACTERÍSTICAS

- Selim mtb vazado
- Ergonômico
- Trilho de aço
- Ótima ventilação
- Confortável
- Excelente acabamento
- Base em PU de alta resistência
- Assento em espuma

### MATERIAL

Poliuretano e aço

### PESO

406g

### EMBALAGEM

25 peças

24722



## SELIM MTB PRETO VAZADO MOD.22

### CARACTERÍSTICAS

- Selim mtb vazado
- Ergonômico
- Trilho de aço
- Ótima ventilação
- Confortável
- Excelente acabamento
- Base em PU de alta resistência
- Assento em espuma

### MATERIAL

Poliuretano e aço

### TAMANHO

162mm x 250mm

### PESO

258g

### EMBALAGEM

25 peças

24723



FOTOS MERAMENTE ILUSTRATIVAS. AS INFORMAÇÕES/CONFIGURAÇÕES DE PRODUTOS PODERÃO SOFRER ALTERAÇÕES SEM AVISO PRÉVIO.

ENTRE EM CONTATO COM O SEU CONSULTOR OU FALE COM O NOSSO TIME DE TELEVENDAS PELO (33) 3277-3030.

## SUPORTE FIX. SUP CARAMANHOLA PRETO

<b>MODELO</b>	FJJ-280N
<b>CARACTERÍSTICA</b>	Pode ser montado horizontalmente ou verticalmente, adequada para bicicletas dobráveis, MTB e Road
<b>MATERIAL</b>	Alumínio
<b>TAMANHO</b>	Diâmetro do selim ou guidão: 21 - 34 cm
<b>PESO</b>	34g
<b>EMBALAGEM</b>	50 peças
	16219



## SUPORTE DE CARAMANHOLA I SJJ-25212

<b>MODELO</b>	SJJ-25212
<b>CARACTERÍSTICA</b>	Acesso Standard (meio)   Incluso 2 parafusos Allen
<b>MATERIAL</b>	Alumínio
<b>TAMANHO</b>	147 x 79 x 76 mm
<b>PESO</b>	42g
<b>EMBALAGEM</b>	100 peças
	16220



## SUPORTE CARAMANHOLA ALUM MOD.02

<b>CARACTERÍSTICA</b>	Caramanhola / Garrafa água comum   Super Leve   Fácil instalação   Durável   Resistente
<b>MATERIAL</b>	Alumínio
<b>TAMANHO</b>	145 x 76 mm
<b>PESO</b>	40g
<b>EMBALAGEM</b>	100 unidades
	23581

FOTOS MERAMENTE ILUSTRATIVAS. AS INFORMAÇÕES/CONFIGURAÇÕES DE PRODUTOS PODERÃO SOFRER ALTERAÇÕES SEM AVISO PRÉVIO.

ENTRE EM CONTATO COM O SEU CONSULTOR OU FALE COM O NOSSO TIME DE TELEVENDAS PELO (33) 3277-3030.

## MOVIMENTO CENTRAL BB-91DUB SR

**MODELO** BB-91DUB SR

**CARACTERÍSTICA**

- BSA
- Padrão dub
- Compatível com caixa 68mm e 73mm
- Acompanha arruelas calço

**MATERIAL** Alumínio e plástico

**TAMANHO** Ø34.7mm

**PESO** 90g

**EMBALAGEM** 20 peças

24701



## MOVIMENTO CENTRAL BB-92DUB SR

**MODELO** BB-92DUB SR

**CARACTERÍSTICA**

- Padrão dub
- Compatível com caixa 89,5mm e 92mm
- Acompanha arruelas calço

**MATERIAL** Alumínio e plástico

**TAMANHO** Ø41mm

**PESO** 84g

**EMBALAGEM** 20 peças

24702

FOTOS MERAMENTE ILUSTRATIVAS. AS INFORMAÇÕES/CONFIGURAÇÕES DE PRODUTOS PODERÃO SOFRER ALTERAÇÕES SEM AVISO PRÉVIO.

ENTRE EM CONTATO COM O SEU CONSULTOR OU FALE COM O NOSSO TIME DE TELEVENDAS PELO (33) 3277-3030.



**GLUE**

M5

Kip

**GLUE**



## CAPACETE MTB M5 MIPS

Característica	In mold com mips
Aberturas de circulação de ar	14 aberturas
Sistema de fechamento	Fivela
Enchimento	Espuma removível   lavável
Sistema regulagem	Orbital
Peso	310 g

**CÓDIGO** 25003- M5 PRETO  
25004- M5 BRANCO



FOTOS MERAMENTE ILUSTRATIVAS. AS INFORMAÇÕES/CONFIGURAÇÕES DE PRODUTOS PODERÃO SOFRER ALTERAÇÕES SEM AVISO PRÉVIO.

ENTRE EM CONTATO COM O SEU CONSULTOR OU FALE COM O NOSSO TIME DE TELEVENDAS PELO (33) 3277-3030.

## SELIM MTB VAZADO MOD 1168

Material	Carbono + Couro Microfibra
Tamanho	275x153x65mm   275x143x65mm
Tipo de Fixação	Trilho oval   Este tipo de trilho não é compatível com todo tipo de canote.
Material do trilho	Fibra de carbono
Material de cobertura	Couro Microfibra
Modelo	Vazado
Limite de peso	80kg
Dimensão do trilho	153mm   143mm
Torque	2-4Nm
Peso	180,5g

**CÓDIGO** 25008 - 153 MM  
25007 - 143 MM



## SELIM MTB VAZADO MOD 1169

Material	Polímero + Náilon reforçado + Aço cromolibdênio
Tamanho	270x143x65mm
Tipo de Fixação	Trilho
Material do trilho	Aço cromolibdênio
Material de cobertura	Polímero impressão 3D
Modelo	Vazado
Dimensão do trilho	143mm
Peso	255g

**CÓDIGO** 25011 - 143 MM



## SELIM MTB VAZADO MOD 1189

Material	Couro de Microfibras + Fibra de carbono
Tamanho	240x155x75mm   240x143x75mm
Tipo de Fixação	Trilho
Material do trilho	Fibra de carbono
Material de cobertura	Couro Microfibras
Modelo	Vazado
Limite de peso	80kg
Dimensão do trilho	153mm   143mm
Torque	2-4Nm
Peso	132g

**CÓDIGO** 25006 - 155 MM  
25010 - 143 MM



## SELIM MTB VAZADO MOD 1168

Material	Couro de Microfibras + Fibra de carbono
Tamanho	280x148x56mm
Tipo de Fixação	Trilho oval   Este tipo de trilho não é compatível com todo tipo de canote.
Material do trilho	Fibra de carbono
Material de cobertura	Couro Microfibras
Modelo	Vazado
Limite de peso	80kg
Dimensão do trilho	148mm
Torque	2-4Nm
Peso	124g

**CÓDIGO** 25009 - 148 MM



## ABRAÇADEIRA DE SELIM MTB 34.9 LIGHT PT

Material	Alumínio
Tamanho	34.9mm
Torque	6 Nm
Peso	8,6g

**CÓDIGO** 25015



FOTOS MERAMENTE ILUSTRATIVAS. AS INFORMAÇÕES/CONFIGURAÇÕES DE PRODUTOS PODERÃO SOFRER ALTERAÇÕES SEM AVISO PRÉVIO.

ENTRE EM CONTATO COM O SEU CONSULTOR OU FALE COM O NOSSO TIME DE TELEVENDAS PELO (33) 3277-3030.

## SELIM MTB VAZADO MOD 1136

Material	Couro de Microfibrã + Aço cromo molibdênio + PP
Tamanho	250x144x73mm
Tipo de Fixação	Trilho
Material do trilho	Aço cromo molibdênio
Material de cobertura	Couro de microfibrã
Modelo	Vazado
Dimensão do trilho	144mm
Peso	194g

**CÓDIGO** 25005 - 144 MM



## NIPLE ALUMÍNIO 14MM

Material	Alumínio
Tamanho	14mm
Peso	14g

**CÓDIGO** 25012 - 14MM PT  
25013 - 14MM VM  
25014 - 14MM AZ



FOTOS MERAMENTE ILUSTRATIVAS. AS INFORMAÇÕES/CONFIGURAÇÕES DE PRODUTOS PODERÃO SOFRER ALTERAÇÕES SEM AVISO PRÉVIO.

ENTRE EM CONTATO COM O SEU CONSULTOR OU FALE COM O NOSSO TIME DE TELEVENDAS PELO (33) 3277-3030.



# OILGRAPHE®

**O LUBRIFICANTE OILGRAPHE** é um produto super revolucionário e novíssimo no mercado. O fabricante tem toda uma linha de produtos fabricados com nanotecnologia, tendo como princípio ativo o grafeno, voltado ao tratamento de metais.

Lubrificante de alta performance derivado de hidrocarbonetos, grafeno, nanopartículas de grafita natural cristalina de alta pureza, carbono em alta concentração, anticorrosivos naturais, camponentes anti desgastantes e compostos antioxidantes extremamente estáveis.



# OILGRAPHE®

O LUBRIFICANTE OILGRAPHE é um produto super revolucionário e novíssimo no mercado. O fabricante tem toda uma linha de produtos fabricados com nanotecnologia, tendo como princípio ativo o grafeno, voltado ao tratamento de metais.

Lubrificante de alta performance derivado de hidrocarbonetos, grafeno, nanopartículas de grafita natural cristalina de alta pureza, carbono em alta concentração, anticorrosivos naturais, componentes anti desgastantes e compostos antioxidantes extremamente estáveis.



ECONOMIA  
DE ENERGIA



DIMINUI  
O RUÍDO



REDUZ  
CUSTOS DE  
MANUTENÇÃO



HIDROFÓBICO



**100ml**

Código: 20196

Embalagem: 20 peças

**30ml**

Código: 20195

Embalagem: 20 peças

FOTOS MERAMENTE ILUSTRATIVAS. AS INFORMAÇÕES/CONFIGURAÇÕES DE PRODUTOS PODERÃO SOFRER ALTERAÇÕES SEM AVISO PRÉVIO.

ENTRE EM CONTATO COM O SEU CONSULTOR OU FALE COM O NOSSO TIME DE TELEVENDAS PELO (33) 3277-3030.

## CERA WHITE MAX COM GRAFENO OILGRAPHE | 30ML



### COMPOSIÇÃO

Desengraxante e lubrificante à base de pasta com partículas micrométricas e hidrocarbonetos de cadeia média.

Complementa a formulação éter e amina glicólica formando uma graxa de alta performance solúvel em água para suportar atrito, temperatura em condições extremas de utilização.

### ADVERTÊNCIA

- Produto não inflamável;
- Produto não tóxico;
- Manter fora do alcance das crianças;
- Se ingerido, consulte imediatamente o centro de intoxicação ou serviço de saúde mais próximo.

### APLICAÇÃO

Para obter total benefício do lubrificante White Wax 5x1, é importantíssimo aplica-lo corretamente, siga as instruções abaixo:

1. Agite bem antes de usar;
2. Aplique o White Wax 5x1 na corrente limpa e seca;
3. Pode ser usado para limpar e desengraxar;
4. Aplique na parte interior da corrente, ao mesmo tempo, que os pedais giram assegurando que o lubrificante penetre em todos os elos.

### BENEFÍCIOS

- Hidrofóbico;
- 100% Livre de solventes;
- Antioxidante;
- Conserva o metal;
- Lubrificante;
- Desengraxante.

### EMBALAGEM

20 peças

### PESO

45 gr

20574

## CERA WHITE MAX COM GRAFENO OILGRAPHE | 100ML



### COMPOSIÇÃO

Desengraxante e lubrificante à base de pasta com partículas micrométricas e hidrocarbonetos de cadeia média.

Complementa a formulação éter e amina glicólica formando uma graxa de alta performance solúvel em água para suportar atrito, temperatura em condições extremas de utilização.

### ADVERTÊNCIA

- Produto não inflamável;
- Produto não tóxico;
- Manter fora do alcance das crianças;
- Se ingerido, consulte imediatamente o centro de intoxicação ou serviço de saúde mais próximo.

### APLICAÇÃO

Para obter total benefício do lubrificante White Wax 5x1, é importantíssimo aplica-lo corretamente, siga as instruções abaixo:

1. Agite bem antes de usar;
2. Aplique o White Wax 5x1 na corrente limpa e seca;
3. Pode ser usado para limpar e desengraxar;
4. Aplique na parte interior da corrente, ao mesmo tempo, que os pedais giram assegurando que o lubrificante penetre em todos os elos.

### BENEFÍCIOS

- Hidrofóbico;
- 100% Livre de solventes;
- Antioxidante;
- Conserva o metal;
- Lubrificante;
- Desengraxante.

### EMBALAGEM

20 peças

### PESO

114 gr

20575



**SR SUNTOUR**





## LOWER LEG XCR32 EIXO 9MM C/ KIT DE RASPADORES SUNTOUR

Característica	Diâmetro interno 32mm   Old 100mm Eixo 9 x 100mm   Aro 29" Suporte de freio post mount 160mm direct   Acompanha kit raspadores Acompanha mancal   Acompanha lubrificadores (espumas internas) Compatível com pistões rl-r (não incluso)   Código do fabricante FKH128-01   Recomendação ficha técnica sf21-xcr32-atb-ds-rl-r 29"
Material	Magnésio
Peso	686gr – Kit completo
Embalagem	05 peças
Catálogo Grupo JPP	Compatível com todas as XCR's canela 32mm modelo atb

23511



## LOWER LEG XCR32 C/ KIT DE RASPADORES SUNTOUR

Característica	Diâmetro interno 32mm   Boost (old 110mm)   Eixo 15 x 110mm   Aro 29" Blocagem compatível ø15qlc32-110 alxe set (não incluso)   Suporte de freio post mount 160mm direct Acompanha kit raspadores Acompanha mancal   Acompanha lubrificadores (espumas internas) Compatível com pistões rl-r (não incluso)   Código do fabricante FKH075-01   Recomendação ficha técnica xcr32-boost-air rlr ds 15qlc32-110 29"
Material	Magnésio
Peso	636gr – Kit completo
Embalagem	05 peças
Catálogo Grupo JPP	Compatível com todas as XCR's canela 32mm boost com pistão rl-r

23505



FOTOS MERAMENTE ILUSTRATIVAS. AS INFORMAÇÕES/CONFIGURAÇÕES DE PRODUTOS PODERÃO SOFRER ALTERAÇÕES SEM AVISO PRÉVIO.

ENTRE EM CONTATO COM O SEU CONSULTOR OU FALE COM O NOSSO TIME DE TELEVENDAS PELO (33) 3277-3030.



## LOWER LEG DUROLUX38 C/ KIT DE RASPADORES SUNTOUR

Característica	Diâmetro interno 38mm   Boost (old 110mm)   Eixo 20 x 110mm   Aro 29"   Blocação compatível ø20lh-110 alxe set (não incluso)   Suporte de freio post mount 203mm direct   Acompanha kit raspadores   Acompanha mancal   Acompanha lubrificadores (espumas internas)   Compatível com pistões r2c2 / air (não incluso)   Código do fabricante FKH134-10   Recomendação ficha técnica durolux38-boost eq r2c2-pcs ds 20lh- 110 29"
Material	Magnésio
Peso	878gr – Kit completo
Embalagem	05 peças
Catálogo Grupo JPP	Compatível com o modelo DUROLUX 38

23513

## LOWER LEG DUROLUX36 C/ KIT DE RASPADORES SUNTOUR

Característica	Diâmetro interno 36MM   Boost (old 110mm)   Eixo 15 x 110mm   Aro 29"   Blocação compatível ø15-110 15qlc2ti-110 (não incluso)   Suporte de freio post mount 180mm direct   Acompanha kit raspadores   Acompanha mancal   Acompanha lubrificadores (espumas internas)   Compatível com pistões r2c2 / air (não incluso)   Código do fabricante FKH031-01   Recomendação ficha técnica Durolux36-boost eq r2c2-pcs ds 15qlc2ti-110 29"
Material	Magnésio
Peso	748gr – Kit completo
Embalagem	05 peças
Catálogo Grupo JPP	Códigos compatíveis 21778 / 21779

23501



## LOWER LEG RAIDON34 C/ KIT DE RASPADORES SUNTOUR

**Característica** Diâmetro interno 34mm | Boost (old 110mm) | Eixo 15 x 110mm | Aro 29" | Blocagem compatível Ø15qlc32-110 alxe set (não incluso) | Suporte de freio post mount 160mm direct | Acompanha kit raspadores | Acompanha mancal | Acompanha lubrificadores (espumas internas) | Compatível com pistões rlrc (não incluso) | Código do fabricante FKH036 | Recomendação ficha técnica sf18-axon34-ds-boost-rl-rc-pcs-15qlc2-110 29"

**Material** Magnésio

**Peso** 684gr – Kit completo

**Embalagem** 05 peças

**Catálogo Grupo JPP** Compatível com todas as AXON's canela 34mm boost com pistão rlrc

23502



## LOWER LEG AXON34 C/ KIT DE RASPADORES SUNTOUR

**Característica** Diâmetro Interno 34mm | Boost (Old 110mm) | Eixo 15 X 110mm | Aro 29" | Blocagem Compatível Ø15qlc2ti-110 | Alxe Set (Não Incluso) | Suporte De Freio Post Mount 160mm Direct | Acompanha Kit Raspadores | Acompanha Mancal | Acompanha Lubrificadores (Espumas Internas) | Compatível Com Pistões Rlrc (Não Incluso) | Código Do Fabricante FKH078-00 | Recomendação Ficha Técnica Axon34-Werx-Boost Eq Rlrc-Pcs Ds 15qlc2ti-110 29"

**Material** Magnésio

**Peso** 624gr – Kit completo

**Embalagem** 05 peças

**Catálogo Grupo JPP** Compatível com todas as AXON's canela 34mm boost modelo Elite e Werx

23507



## LOWER LEG RUX38 C/ KIT DE RASPADORES SUNTOUR

Característica	Diâmetro interno 38mm   Boost (old 110mm)   Eixo 20 x 110mm   Aro 29"   Blocagem compatível ø20-110 thru axle set (não incluso)   Suporte de freio post mount 203mm direct   Acompanha kit raspadores   Acompanha mancal   Acompanha lubrificadores (espumas internas)   Compatível com pistões r2c2 / air (não incluso)   Código do fabricante FKH135-10   Recomendação ficha técnica rux38-boost eq r2c2-pcs ds t 29"
Material	Magnésio
Peso	818gr – Kit completo
Embalagem	05 peças
Catálogo Grupo JPP	Compatível com o modelo RUX 38

23514



## LOWER LEG AION36 C/ KIT DE RASPADORES SUNTOUR

Característica	Diâmetro interno 36mm   Boost (old 110mm)   Eixo 15 x 110mm   Aro 29"   Blocagem compatível ø15h-110 axle set (não incluso)   Suporte de freio post mount 180mm direct   Acompanha kit raspadores   Acompanha mancal   Acompanha lubrificadores (espumas internas)   Compatível com pistões rlrc / air (não incluso)   Código do fabricante FKH136-00   Recomendação ficha técnica sf23-aion36-boost-eq-rl-rc-pcs-ds-15h-110-29"
Material	Magnésio
Peso	826gr – Kit completo
Embalagem	05 peças
Catálogo Grupo JPP	Compatível com o modelo AION 36

23515



## LOWER LEG XCR34 C/ KIT DE RASPADORES SUNTOUR

Característica	Diâmetro interno 34mm   Boost (old 110mm)   Eixo 15 x 110mm   Aro 29"   Blocagem compatível ø15lh-110 axle set (não incluso)   Suporte de freio post mount 180mm direct   Acompanha kit raspadores   Acompanha mancal   Acompanha lubrificadores (espumas internas)   Compatível com pistões rl-r (não incluso)   Código do fabricante FKH141-10   Recomendação ficha técnica sf23-xcr34-boost-air-r-2cr-ds-15lh-110-29"
Material	Magnésio
Peso	775gr – Kit completo
Embalagem	05 peças
Catálogo Grupo JPP	Compatível com todas as XCR's canela 34mm boost com pistão rl-r

23517



## CONJUNTO SUPERIOR DO GARFO SUNTOUR

Característica	Crown forjado em alumínio   Coroa em alumínio oca   Espiga tapered em alumínio (28.6 X 39.9mm)   Comprimento da espiga 270mm   Canela 38mm   Código do fabricante FKH132-10
Material	Alumínio
Peso	1262gr
Embalagem	05 peças
Catálogo Grupo JPP	Compatível com suspensões DUROLUX38

23367



## CONJUNTO SUPERIOR DO GARFO SUNTOUR

Característica Crown forjado em alumínio  
Coroa em alumínio oca  
Espiga tapered em alumínio (28.6 X 39.9mm)  
Comprimento da espiga 270mm  
Canela 36mm  
Código do fabricante FKH030-02

Material Alumínio

Peso 1020gr

Embalagem 05 peças

Catálogo Grupo JPP Compatível com suspensões DUROLUX36

23500



## CONJUNTO SUPERIOR DO GARFO SUNTOUR

Característica Coroa em alumínio  
Espiga tapered em alumínio (28.6 X 39.9mm)  
Comprimento da espiga 270mm  
Canela 32mm  
Código do fabricante FKH073-01

Material Alumínio

Peso 1050gr

Embalagem 05 peças

Catálogo Grupo JPP Compatível com suspensões XCR32 BOOST AIR/COIL

23504



## CONJUNTO SUPERIOR DO GARFO SUNTOUR

Característica Coroa em fibra de carbono  
Espiga tapered em fibra de carbono (28.6 X 39.9mm)  
Comprimento da espiga 270mm  
Canela 34mm  
Compatível com suspensões AXON34 werx carbon boost  
Código do fabricante FKH077-01

Material Carbono

Peso 654gr

Embalagem 05 peças

Catálogo Grupo JPP Compatível com suspensões AXON34 WERX CARBON BOOST

23506



## CONJUNTO SUPERIOR DO GARFO SUNTOUR

Característica Crown forjado em alumínio  
Coroa em alumínio oca  
Espiga tapered em alumínio (28.6 X 39.9mm)  
Comprimento da espiga 270mm  
Canela 34mm  
Código do fabricante FKH079-03

Material Alumínio

Peso 762 gr

Embalagem 05 peças

Catálogo Grupo JPP Compatível com suspensões AXON34 ELITE BOOST

23508

## CONJUNTO SUPERIOR DO GARFO SUNTOUR

Característica Coroa em alumínio  
Espiga tapered em alumínio (28.6 X 39.9mm)  
Comprimento da espiga 270mm  
Canela 34mm  
Compatível com suspensões Axon34 boost  
Código do fabricante FHK035-1

Material Alumínio

Peso 845 gr

Embalagem 05 peças

Catálogo Grupo JPP Compatível com suspensões AXON34 BOOST

23440



## CONJUNTO SUPERIOR DO GARFO SUNTOUR

Característica Coroa em alumínio  
Espiga tapered em aço (28.6 X 39.9mm)  
Comprimento da espiga 270mm  
Canela 32mm  
Código do fabricante FKH126-11

Material Alumínio/aço

Peso 1348 gr

Embalagem 05 peças

Catálogo Grupo JPP Compatível com suspensões XCR32 ATB AIR

23510





## CONJUNTO SUPERIOR DO GARFO SUNTOUR

Característica	Coroa em alumínio Espiga tapered em alumínio (28.6 X 39.9mm) Comprimento da espiga 270mm Canela 36mm Código do fabricante FKH138
Material	Alumínio
Peso	1058 gr
Embalagem	05 peças
Catálogo Grupo JPP	Compatível com suspensões AION36 BOOST  23516



## GARFO TUBO SUNTOUR

Característica	Diâmetro do tubo 38mm Comprimento 560mm Código do fabricante FPA196-02   Disponível para lado esquerdo (L) e lado direito (R)
Material	Alumínio
Peso	348 gr
Embalagem	05 peças
Catálogo Grupo JPP	Compatível com suspensões RUX38 BOOST

23532 / Lado direito

23533 / Lado esquerdo

## CONJUNTO SUPERIOR DO GARFO SUNTOUR

Característica	Coroa em alumínio Espiga tapered em alumínio (28.6 X 39.9mm) Comprimento da espiga 270mm Canela 34mm Código do fabricante FKH138
Material	Alumínio
Peso	1108 gr
Embalagem	05 peças
Catálogo Grupo JPP	Compatível com suspensões XCR34 BOOST AIR  23518



FOTOS MERAMENTE ILUSTRATIVAS. AS INFORMAÇÕES/CONFIGURAÇÕES DE PRODUTOS PODERÃO SOFRER ALTERAÇÕES SEM AVISO PRÉVIO.

ENTRE EM CONTATO COM O SEU CONSULTOR OU FALE COM O NOSSO TIME DE TELEVENDAS PELO (33) 3277-3030.

## CONJUNTO SUPERIOR DO GARFO SUNTOUR

Característica	Coroa em alumínio Espiga tapered em aço (28.6 X 39.9mm) Comprimento da espiga 270mm Canela 32mm Código do fabricante FKH126-01
Material	Alumínio/aço
Peso	1344 gr
Embalagem	05 peças
Catálogo Grupo JPP	Compatível com suspensões XCR32 ATB  23509



## CONJUNTO DE COROA INFERIOR C/ EPIGA SUNTOUR

Característica	Crown forjado em alumínio Coroa em alumínio oca Espiga tapered em alumínio (28.6 X 39.9mm) Comprimento da espiga 245mm Canela 38mm Código do fabricante FKH061-01
Material	Alumínio
Peso	378 gr
Embalagem	05 peças
Catálogo Grupo JPP	Compatível com suspensões RUX38 BOOST  23503



## GARFO 29" COM SUSPENSÃO XCR32RLR-AIR 100MM TAPERED | 110X15MM PT

Característica Crown AC4C | Tapered | Lower Leg Magnesium canela 32 | Trava no ombro em alumínio com abraçadeira - Suntour | Funcionamento a ar | Regulagem de retorno | Suporte do freio Post Mount 160mm | Curso de 100mm | Eixo de 15mm | OLD 110mm | Off set: 46 mm | Espiga alumínio Tapered ahead set (diâmetro superior 28.6mm / diâmetro inferior 39.8mm) 1/8 x 1.5

Comprimento da espiga 250mm  
Abraçadeira 35mm | Acompanha calço redutor para Seat Tube 31.8mm | Montagem com abraçadeira e montagem direta tipo E. Usinagem CNC de alta qualidade.

Material Alumínio  
Peso 2395 gr - incluindo eixo, trava e cabo  
Embalagem 10 peças  
20582



### AVISOS

USE APENAS PARA:

- LAZER
- CROSS COUNTRY

## GARFO 29" MTB COM SUSPENSÃO XCM 100MM TAPERED | 100X9MM PT

Característica Crown AC4C | Lower Leg Alumínio Trava Remota no Guidão - Pistão | Trava em alumínio com abraçadeira - Suntour | Funcionamento a Mola | Suporte do Freio Post Mount 160mm | Curso de 100mm | Eixo de 9mm | OLD 100mm | Off set: 46 mm | Espiga Aço Tapered ahead set (diâmetro superior 28.6mm / diâmetro inferior 39.8mm) 1/8 x 1.5 | Comprimento da espiga 250mm

Material Alumínio  
Peso 2850 gr - incluindo trava e cabo  
Embalagem 10 peças  
20157



### AVISOS

USE APENAS PARA:

- LAZER
- CROSS COUNTRY

FOTOS MERAMENTE ILUSTRATIVAS. AS INFORMAÇÕES/CONFIGURAÇÕES DE PRODUTOS PODERÃO SOFRER ALTERAÇÕES SEM AVISO PRÉVIO.

ENTRE EM CONTATO COM O SEU CONSULTOR OU FALE COM O NOSSO TIME DE TELEVENDAS PELO (33) 3277-3030.

## GARFO 29" MTB COM SUSPENSÃO XCM 100MM AHEAD | 100X9MM PT

Característica Garfo suspensão Suntour | Crown AC4C  
Lower Leg alumínio | Trava remota no guidão  
- pistão | Trava em alumínio com abraçadeira  
- Suntour | Funcionamento a mola | Suporte  
do freio Post Mount 160mm | Curso de  
100mm | Eixo de 9mm | OLD 100mm | Off  
set: 46 mm | Espiga aço ahead set (diâmetro  
28.6mm) | Comprimento da espiga 250mm

Material Alumínio

Peso 2950 gr - incluindo trava e cabo

Embalagem 10 peças

20492



### AVISOS

USE APENAS PARA:

- LAZER
- CROSS COUNTRY

## GARFO 29" MTB COM SUSPENSÃO XCR AIR AHEAD 9MM PT

Característica Garfo 29" MTB Suntour XCR 32:  
Garfo suspensão Suntour | Crown ACA4  
| Lower Leg Magnesium | Canela 32 | Trava  
remota no guidão - Pistão | Trava em alumínio  
com abraçadeira - Suntour | Funcionamento a ar  
| Regulagem de Rebound | Suporte do freio Post  
Mount 160 mm | Curso de 100 mm | Eixo de 9 mm  
| OLD 100 mm | Espiga em aço aheadset  
(diâmetro 28.6 mm / diâmetro 1.1/8) | Comprimento  
da espiga 250 mm

Material Alumínio

Peso 2512 gr - incluindo trava

Embalagem 10 peças

21816



### AVISOS

USE APENAS PARA:

- LAZER
- CROSS COUNTRY



## GARFO 29" MTB COM SUSPENSÃO AXON AHEAD 15MM BOOST PT

Característica	Garfo aro 29" com suspensão Suntour Axon Boost: Offset 46 mm   Boost OLD 110 mm   Espiga Tapered ( 1.5"to1-1/8" )   Lado direito com Pistão RLRC, LORC   Trava remota   Lado esquerdo câmara de ar   Crown série A6000/ Forjada oca   Pitch 133mm   Lower Leg Magnesium   Freio Postmount   Compatível com discos até 180 mm   Blocação Axle ø15-110 15QLC2-110   Cross Country
Material	Alumínio
Peso	1942 gr ( suspensão, blocagem, trava remota e paralamas)
Embalagem	10 peças
	22714



<b>AVISOS</b>	USE APENAS PARA:
	<ul style="list-style-type: none"> <li>• LAZER</li> <li>• CROSS COUNTRY</li> </ul>

## GARFO 29 MTB C/SUSP XCM34 100MM. TAP. 110X15MM PT

Característica	Canela em aço 34mm Lower leg em alumínio Crown em alumínio Boost Off set 51mm Regulagem de preload Suporte de freio post mount Compatível com disco 160mm post mount Tamanho máximo do disco 203mm Trava remota Curso de 100mm Eixo de 15mm   Old 110mm Espiga em aço over ahead set 1.5" X 1-1/8" (diâmetro superior 28.6mm / diâmetro inferior 40mm / comprimento 270mm) Compatível com e-bike Casual mtb
Material	Alumínio
Peso	3420g
Embalagem	10 unidades
	21720



<b>AVISOS</b>	USE APENAS PARA:
	<ul style="list-style-type: none"> <li>• LAZER</li> <li>• CROSS COUNTRY</li> </ul>

FOTOS MERAMENTE ILUSTRATIVAS. AS INFORMAÇÕES/CONFIGURAÇÕES DE PRODUTOS PODERÃO SOFRER ALTERAÇÕES SEM AVISO PRÉVIO.

ENTRE EM CONTATO COM O SEU CONSULTOR OU FALE COM O NOSSO TIME DE TELEVENDAS PELO (33) 3277-3030.

## GARFO 29 MTB C/SUSP XCM34 120MM. TAP. 110X15MM PT

Característica	Canela em aço 34mm Lower leg em alumínio Crown em alumínio Boost Off set 51mm Regulagem de preload Suporte de freio post mount Compatível com disco 160mm post mount Tamanho máximo do disco 203mm Trava remota Curso de 120mm Eixo de 15mm   Old 110mm Espiga em aço over ahead set 1.5" X 1-1/8" (diâmetro superior 28.6mm / diâmetro inferior 40mm / comprimento 270mm) Compatível com e-bike Casual mtb
Material	Alumínio
Peso	3420g
Embalagem	10 unidades  21721



### AVISOS

USE APENAS PARA:

- LAZER
- CROSS COUNTRY

## GARFO 29 MTB C/SUSP XCM32 100MM. TAP. 110X15MM PT

Característica	Canela em aço 32mm Lower leg em alumínio Crown em alumínio Boost Off set 47mm Regulagem de preload Suporte de freio post mount Compatível com disco 160mm post mount Tamanho máximo do disco 180mm Trava remota Curso de 100mm Eixo de 15mm   Old 110mm Espiga em aço over ahead set 1.5" X 1-1/8" (diâmetro superior 28.6mm / diâmetro inferior 40mm / comprimento 270mm) Casual mtb
Material	Alumínio / Aço
Peso	3150g
Embalagem	10 peças  21722



### AVISOS

USE APENAS PARA:

- LAZER
- CROSS COUNTRY



FOTOS MERAMENTE ILUSTRATIVAS. AS INFORMAÇÕES/CONFIGURAÇÕES DE PRODUTOS PODERÃO SOFRER ALTERAÇÕES SEM AVISO PRÉVIO.

ENTRE EM CONTATO COM O SEU CONSULTOR OU FALE COM O NOSSO TIME DE TELEVENDAS PELO (33) 3277-3030.

## GARFO 29 MTB C/SUSP XCM 100MM. AHEAD 100X9MM PT

Característica	Canela em aço 30mm Lower leg em alumínio Crown em alumínio Off set 46mm Regulagem de preload Suporte de freio post mount Compatível com disco 160mm post mount Tamanho máximo do disco 180mm Trava remota Curso de 100mm Eixo de 9mm   Old 100mm Espiga em aço over ahead set 1-1/8" (diâmetro 28.6mm / comprimento 255mm) Casual mtb
Material	Alumínio
Peso	2738g
Embalagem	10 peças 21723



### AVISOS

USE APENAS PARA:

- LAZER
- CROSS COUNTRY



## GARFO 29 MTB C/SUSP XCT 100MM. AHEAD 100X9MM PT

Característica	Canela em aço 30mm Lower leg em alumínio Crown em alumínio Off set 46mm Regulagem de preload Suporte de freio post mount Compatível com disco 160mm post mount Tamanho máximo do disco 180mm Trava manual Curso de 100mm Eixo de 9mm   Old 100mm Espiga em aço over ahead set 1-1/8" (diâmetro 28.6mm / comprimento 255mm) Casual mtb
Material	Alumínio/ Aço
Peso	2900g
Embalagem	10 peças 21724



### AVISOS

USE APENAS PARA:

- LAZER
- CROSS COUNTRY

FOTOS MERAMENTE ILUSTRATIVAS. AS INFORMAÇÕES/CONFIGURAÇÕES DE PRODUTOS PODERÃO SOFRER ALTERAÇÕES SEM AVISO PRÉVIO.

ENTRE EM CONTATO COM O SEU CONSULTOR OU FALE COM O NOSSO TIME DE TELEVENDAS PELO (33) 3277-3030.

## GARFO 29 MTB C/SUSP XCT 80MM. AHEAD 100X9MM PT

Característica	Canela em aço 30mm Lower leg em alumínio Crown em alumínio Off set 46mm Regulagem de preload Suporte de freio post mount Compatível com disco 160mm post mount Tamanho máximo do disco 180mm Trava manual Curso de 80mm Eixo de 9mm   Old 100mm Espiga em aço over ahead set 1-1/8" (diâmetro 28.6mm / comprimento 255mm) Casual mtb
Material	Alumínio/ Aço
Peso	2900g
Embalagem	10 peças  21725

### AVISOS

USE APENAS PARA:

- LAZER
- CROSS COUNTRY



## GARFO 29 MTB C/SUSP XCE 80MM. AHEAD 100X9MM PT

Característica	Canela em aço 28mm Lower leg em alumínio Crown em alumínio Off set 46mm Regulagem de preload Suporte de freio post mount Compatível com disco 160mm post mount Tamanho máximo do disco 180mm Curso de 80mm Eixo de 9mm   Old 100mm Espiga em aço over ahead set 1-1/8" (diâmetro 28.6mm / comprimento 255mm) Casual mtb
Material	Alumínio
Peso	2660g
Embalagem	10 peças  21726

### AVISOS

USE APENAS PARA:

- LAZER
- CROSS COUNTRY





## GARFO 29 C/SUSP AXON32RLRC 100MM. TAP. 110X15MM PT

- Característica
- Boost (15x110mm)
  - Trava remota
  - Lower leg em magnésio (diâmetro 32 )
  - Curso do amortecedor 100mm
  - Medida máxima do pneu 2.40
  - Off set 46mm
  - Espiga tapered (1.5" X 1/8") Alumínio
  - Comprimento da espiga 280mm
  - Lado direito pistão rirc
  - Lado esquerdo air spring
  - Crown alumínio
  - Suporte de freio post mount 160mm direct
  - Tamanho máximo do disco 180mm
  - Blocação compatível ø15-110 15qlc2-110
  - Acompanha paralamas
  - Recomendada para cross country

Material Alumínio

Peso 1900gr - peso da suspensão e eixo

Embalagem 10 peças

23738



AVISOS USE APENAS PARA:

- LAZER
- CROSS COUNTRY

## GARFO 29 C/SUSP DH RUX38R2C2 200MM. TAP. 110X20MM PT

- Característica
- Boost (20x110mm)
  - Lower Leg Em Magnésio (Diâmetro 38 )
  - Curso Do Amortecedor 200mm
  - Crown Oco
  - Medida Máxima Do Pneu 2.60
  - Off Set 50 Mm
  - Espiga Tapered (1.5" X 1/8") Alumínio
  - Comprimento Da Espiga 245mm
  - Lado Direito Pistão R2c2-Pcs
  - Lado Esquerdo Air Spring
  - Crown Forjado Oco
  - Suporte De Freio Post Mount 203mm Direct
  - Tamanho Máximo Do Disco 203mm
  - Blocação Compatível Ø20-110 Tipo De Ferramenta/ Sem Ferramenta
  - Acompanha Paralamas
  - Recomendada Para Downhill E Freeride
  - Compatível Com E-Bike

Material Alumínio

Peso 2750gr - peso da suspensão e eixo

Embalagem 10 peças

21773



AVISOS USE APENAS PARA:

- LAZER
- CROSS COUNTRY

FOTOS MERAMENTE ILUSTRATIVAS. AS INFORMAÇÕES/CONFIGURAÇÕES DE PRODUTOS PODERÃO SOFRER ALTERAÇÕES SEM AVISO PRÉVIO.

ENTRE EM CONTATO COM O SEU CONSULTOR OU FALE COM O NOSSO TIME DE TELEVENDAS PELO (33) 3277-3030.

## GARFO 29 C/SUSP DUROLUX38R2C2 160MM. TAP. 110X20MM PT

Característica	Boost (20x110mm) Lower Leg Em Magnésio ( Diâmetro 38 ) Curso Do Amortecedor 160mm/170mm/180mm Medida Máxima Do Pneu 2.60 Tecnologia Eq (Equalizer) Off Set 44 Mm Espiga Tapered (1.5" X 1.1/8") Alumínio Comprimento Da Espiga 270mm Lado Direito Pistão R2c2-Pcs Lado Esquerdo Air Spring Crown R2c2-Pcs Forjado Oco Suporte De Freio Post Mount 203mm Direct Tamanho Máximo Do Disco 220mm Bloqueio Compatível Ø20-110 20lh-110 Acompanha Paralama Recomendada Para Enduro E Freeride Compatível Com E-Bike
Material	Alumínio
Peso	2650gr - peso da suspensão 160mm e eixo
Embalagem	10 peças



160MM: 21775

170MM: 21776

180MM: 21777

AVISOS

USE APENAS PARA:

- LAZER
- CROSS COUNTRY

## GARFO 29 C/SUSP DUROLUX36R2C2 150MM. TAP. 110X15MM PT

Característica	Boost (15x110mm) Lower Leg Em Magnésio (Diâmetro 36) Curso Do Amortecedor 150mm/160mm Crown Oco Medida Máxima Do Pneu 2.60 Tecnologia Eq (Equalizer) Espiga Tapered (1.5" X 1.1/8") Alumínio Comprimento Da Espiga 270mm Lado Direito Pistão R2c2-Pcs Lado Esquerdo Air Spring Crown R2c2-Pcs Forjado Oco Suporte De Freio Post Mount 180mm Direct Tamanho Máximo Do Disco 203mm Bloqueio Compatível Ø15-110 15qlc2ti-110 Acompanha Paralama Recomendada Para Enduro E Freeride Compatível Com E-Bike
Material	Alumínio
Peso	2260gr
Embalagem	10 peças



150MM: 21778

160MM: 21779

AVISOS

USE APENAS PARA:

- LAZER
- CROSS COUNTRY

FOTOS MERAMENTE ILUSTRATIVAS. AS INFORMAÇÕES/CONFIGURAÇÕES DE PRODUTOS PODERÃO SOFRER ALTERAÇÕES SEM AVISO PRÉVIO.

ENTRE EM CONTATO COM O SEU CONSULTOR OU FALE COM O NOSSO TIME DE TELEVENDAS PELO (33) 3277-3030.

SR SUNTOUR

GRUPO JPP



## GARFO 29 C/SUSP AXON34RLRC 100MM. CARBON TAP. 100X15MM

Característica	Eixo (100x15mm) Trava Remota Lower Leg Em Magnésio (Diâmetro 34 ) Curso Do Amortecedor 100mm Medida Máxima Do Pneu 2.40 Tecnologia Eq (Equalizer) Off Set 51mm Espiga Tapered (1.5" X 1.1/8") Carbono - Acompanha Aranha Comprimento Da Espiga 270mm Lado Direito Pistão Rlrc-Pcs Lado Esquerdo Air Spring Crown Oco Em Carbono Suporte De Freio Post Mount 160mm Direct Tamanho Máximo Do Disco 180mm Blocagem Compatível Ø15-100 15qlc2ti-110 Acompanha Paralama Recomendada Para Cross Country E All Mountain
Material	Alumínio/ Carbono
Peso	1650gr - peso da suspensão 100mm e eixo
Embalagem	10 peças



100MM: 21781    110MM: 21785    120MM: 21786

AVISOS

USE APENAS PARA:

- LAZER
- CROSS COUNTRY

## GARFO 29 C/SUSP AION36RLR TAP. 110X15MM PT

Característica	<ul style="list-style-type: none"> <li>• Boost (15x110mm)</li> <li>• Lower Leg Em Magnésio (Diâmetro 36 )</li> <li>• Curso Do Amortecedor 140mm/150mm/160mm</li> <li>• Trava Remota</li> <li>• Medida Máxima Do Pneu 2.40</li> <li>• Tecnologia Eq (Equalizer)</li> <li>• Off Set 44 Mm</li> <li>• Espiga Tapered (1.5" X 1.1/8") Alumínio</li> <li>• Comprimento Da Espiga 270mm</li> <li>• Lado Direito Pistão Rlrc-Pcs</li> <li>• Lado Esquerdo Air Spring</li> <li>• Crown Alumínio Forjado</li> <li>• Suporte De Freio Post Mount 180mm Direct</li> <li>• Tamanho Máximo Do Disco 220mm</li> <li>• Blocagem Compatível Ø15-110 15lh-110</li> <li>• Acompanha Paralama</li> <li>• Recomendada Para Enduro</li> <li>• Compatível Com E-Bike</li> </ul>
Material	Alumínio
Peso	2350gr - peso da suspensão 120mm e eixo
Embalagem	10 peças



140MM: 21782

150MM: 21783

160MM: 21784

AVISOS

USE APENAS PARA:

- LAZER
- CROSS COUNTRY

FOTOS MERAMENTE ILUSTRATIVAS. AS INFORMAÇÕES/CONFIGURAÇÕES DE PRODUTOS PODERÃO SOFRER ALTERAÇÕES SEM AVISO PRÉVIO.

ENTRE EM CONTATO COM O SEU CONSULTOR OU FALE COM O NOSSO TIME DE TELEVENDAS PELO (33) 3277-3030.

## GARFO 29 C/SUSP AXON34RLRC ELITE 100MM. TAP. 110X15MM P

Característica	<ul style="list-style-type: none"> <li>• Boost (15x110mm)</li> <li>• Lower Leg Em Magnésio ( Diâmetro 34 )</li> <li>• Curso Do Amortecedor 100mm/110mm/120mm</li> <li>• Crown Oco</li> <li>• Medida Máxima Do Pneu 2.40</li> <li>• Tecnologia Eq (Equalizer)</li> <li>• Off Set 44 Mm E 51mm</li> <li>• Espiga Tapered (1.5" X 1.1/8") Alumínio</li> <li>• Comprimento Da Espiga 270mm</li> <li>• Lado Direito Pistão Rlrc-Pcs</li> <li>• Lado Esquerdo Air Spring</li> <li>• Crown Alumínio Forjado Oco</li> <li>• Suporte De Freio Post Mount 160mm Direct</li> <li>• Tamanho Máximo Do Disco 180mm</li> <li>• Blocagem Compatível Ø15-110 15qlc2ti-110</li> <li>• Acompanha Paralama</li> <li>• Recomendada Para Cross Country E All Mountain</li> <li>• Trava Remota – Acompanha Suspensão</li> </ul>
Material	Alumínio
Peso	1750gr - peso da suspensão 100mm e eixo
Embalagem	10 peças



100MM: 21788    110MM: 21789    120MM: 21790

### AVISOS

USE APENAS PARA:

- LAZER
- CROSS COUNTRY

## GARFO 29 C/SUSP AXON34RLRC 100MM. TAP. 110X15MM PT

Característica	<ul style="list-style-type: none"> <li>• Boost (15x110mm)</li> <li>• Trava Remota</li> <li>• Lower Leg Em Magnésio 34</li> <li>• Curso Do Amortecedor 100mm/120mm</li> <li>• Medida Máxima Do Pneu 2.40</li> <li>• Off Set 44 Mm E 51mm</li> <li>• Espiga Tapered (1.5" X 1.1/8") Alumínio</li> <li>• Comprimento Da Espiga 270mm</li> <li>• Lado Direito Pistão Rlrc-Pcs</li> <li>• Lado Esquerdo Air Spring</li> <li>• Crown Alumínio</li> <li>• Lower Leg Em Magnésio</li> <li>• Suporte De Freio Post Mount 180mm Direct</li> <li>• Tamanho Máximo Do Disco 203mm</li> <li>• Blocagem Compatível Ø15-110 15qlc2-110</li> <li>• Acompanha Paralama</li> <li>• Recomendada Para Cross Country E All Mountain</li> <li>• Compatível Com E-Bike</li> </ul>
Material	Alumínio
Peso	2050gr - peso da suspensão 100mm e blocagem
Embalagem	10 peças



100MM: 21791

120MM: 21792

### AVISOS

USE APENAS PARA:

- LAZER
- CROSS COUNTRY

FOTOS MERAMENTE ILUSTRATIVAS. AS INFORMAÇÕES/CONFIGURAÇÕES DE PRODUTOS PODERÃO SOFRER ALTERAÇÕES SEM AVISO PRÉVIO.

ENTRE EM CONTATO COM O SEU CONSULTOR OU FALE COM O NOSSO TIME DE TELEVENDAS PELO (33) 3277-3030.

**SARANTOUR**

GRUPO  
**JPP**

## GARFO 29 C/SUSP XCR34RLR 100MM. TAP. 110X15MM PT

- Característica
- Boost (15x110mm)
  - Lower Leg Em Magnésio ( Diâmetro 34)
  - Trava Remota – Acompanha Trava
  - Curso Do Amortecedor 100mm/120mm
  - Medida Máxima Do Pneu 2.40
  - Tecnologia 2cr (Compression Adjust)
  - Off Set 51mm
  - Espiga Tapered (1.5" X 1.1/8") Alumínio
  - Comprimento Da Espiga 270mm
  - Lado Direito Pistão 2cr
  - Lado Esquerdo Air Spring
  - Crown Ac4c
  - Suporte De Freio Post Mount 180mm Direct
  - Tamanho Máximo Do Disco 203mm
  - Blocagem Compatível Ø15-110 15lh-110
  - Recomendada Para Cross Country

Material Alumínio

Peso 2550gr - peso da suspensão 100mm e eixo

Embalagem 10 peças



AVISOS

USE APENAS PARA:

- LAZER
- CROSS COUNTRY

100MM: 21797 120MM: 21798

## GARFO 29 C/SUSP XCR32RLR-AIR 120MM. TAP. 110X15MM PT

- Característica
- Boost (15x110mm)
  - Lower Leg Em Magnésio ( Diâmetro 32 )
  - Trava Remota
  - Curso Do Amortecedor 100mm/120mm
  - Medida Máxima Do Pneu 2.40
  - Off Set 46mm
  - Espiga Tapered (1.5" X 1.1/8") Alumínio
  - Comprimento Da Espiga 270mm
  - Lado Direito Pistão Rlr
  - Lado Esquerdo Air Spring
  - Crown Ac4c
  - Suporte De Freio Post Mount 160mm Direct
  - Tamanho Máximo Do Disco 180mm
  - Blocagem Compatível Ø15-110 15qlc32-110
  - Recomendada Para Cross Country

Material Alumínio

Peso 2340gr - peso da suspensão 120mm e eixo

Embalagem 10 peças



AVISOS

USE APENAS PARA:

- LAZER
- CROSS COUNTRY

100MM: 21799

120MM: 21800

FOTOS MERAMENTE ILUSTRATIVAS. AS INFORMAÇÕES/CONFIGURAÇÕES DE PRODUTOS PODERÃO SOFRER ALTERAÇÕES SEM AVISO PRÉVIO.

ENTRE EM CONTATO COM O SEU CONSULTOR OU FALE COM O NOSSO TIME DE TELEVENDAS PELO (33) 3277-3030.



## GARFO 29 C/SUSP XCR32RLR-COIL 100MM. TAP. 110X15MM PT

- Característica
- Boost (15x110mm)
  - Lower Leg Em Magnésio (Diâmetro 32)
  - Trava Remota – Acompanha Trava
  - Curso Do Amortecedor 100mm/120mm
  - Medida Máxima Do Pneu 2.40
  - Off Set 46mm
  - Espiga Tapered (1.5" X 1.1/8") Alumínio
  - Comprimento Da Espiga 270mm
  - Lado Direito Pistão Rlr
  - Lado Esquerdo Coil C/ Ajuste De Pré-Carga
  - Crown Ac4c
  - Suporte De Freio Post Mount 160mm Direct
  - Tamanho Máximo Do Disco 180mm
  - Blocação Compatível Ø15-110 15qlc32-110
  - Recomendada Para Cross Country

- Material Alumínio
- Peso 2450gr - peso da suspensão 100mm e eixo
- Embalagem 10 peças



100MM: 21801 120MM: 21802

### AVISOS

USE APENAS PARA:

- LAZER
- CROSS COUNTRY

## GARFO 29 C/SUSP XCR32RLR-COIL 100MM. 100X15MM PT

- Característica
- Eixo (15x100mm)
  - Lower Leg Em Magnésio (Diâmetro 32 )
  - Trava Remota
  - Curso Do Amortecedor 100mm
  - Off Set 46mm
  - Espiga Aço 1.1/8"
  - Comprimento Da Espiga 255mm
  - Lado Direito Pistão Rlr
  - Lado Esquerdo Coil C/ Ajuste De Pré-Carga
  - Crown Ac4c
  - Suporte De Freio Post Mount 160mm Direct
  - Tamanho Máximo Do Disco 180mm
  - Blocação Compatível Ø15-100 15qlc32
  - Recomendada Para Cross Country

- Material Alumínio
- Peso 2700gr - peso da suspensão 100mm e eixo
- Embalagem 10 peças
- 21803

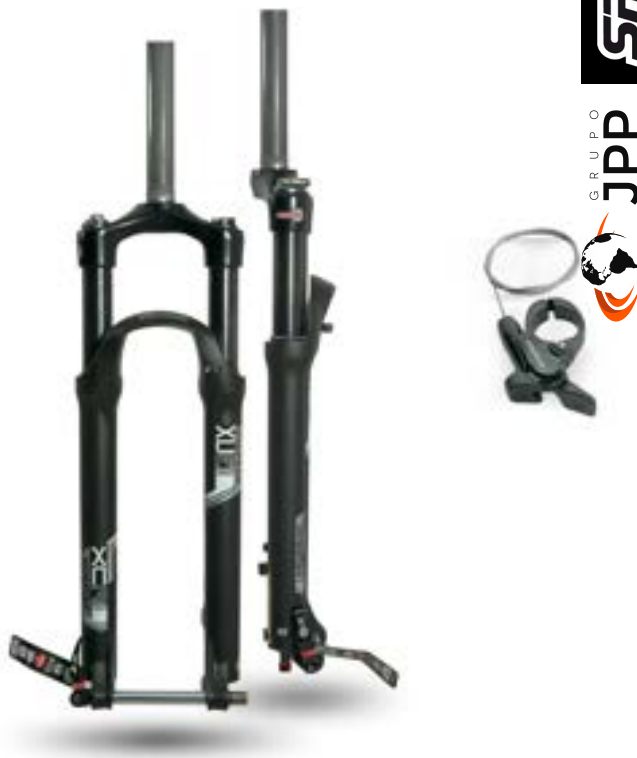

### AVISOS

USE APENAS PARA:

- LAZER
- CROSS COUNTRY

**SR SUNTOUR**

GRUPO **JPP**



## GARFO 29 C/SUSP XCR32-ATB-RLR AIR 100MM. 100X9MM PT

- Característica
- Garfo Aro 29 Sr Suntour Xcr 32 Atb Air Em Alumínio
  - Eixo 9x100mm
  - Lower Leg Em Magnésio ( Diâmetro 32 )
  - Trava Remota
  - Curso Do Amortecedor 100mm
  - Medida Máxima Do Pneu 2.40
  - Off Set 44mm
  - Espiga Tapered (1.5" X 1.1/8") Aço
  - Comprimento Da Espiga 270mm
  - Lado Direito Pistão Rlr
  - Lado Esquerdo Air Spring
  - Crown Ac4c
  - Suporte De Freio Post Mount 160mm Direct
  - Tamanho Máximo Do Disco 180mm
  - Recomendada Para Cross Country
  - Compatível Com E-Bike

Material Alumínio

Peso 2680gr - peso da suspensão 100m

Embalagem 10 peças

21804



AVISOS

USE APENAS PARA:

- LAZER
- CROSS COUNTRY

## GARFO 29 C/SUSP XCR32-ATB-RLR- COIL100MM. TAP. 100X9MM P

- Característica
- Eixo 9x100mm
  - Lower Leg Em Magnésio ( Diâmetro 32 )
  - Trava Remota – Acompanha Trava
  - Curso Do Amortecedor 100mm
  - Medida Máxima Do Pneu 2.40
  - Off Set 44mm
  - Espiga Tapered (1.5" X 1.1/8") Aço
  - Comprimento Da Espiga 270mm
  - Lado Direito Pistão Rlr
  - Lado Esquerdo Coil C/ Ajuste De Pré-Carga
  - Crown Ac4c
  - Suporte De Freio Post Mount 160mm Direct
  - Tamanho Máximo Do Disco 180mm
  - Recomendada Para Cross Country
  - Compatível Com E-Bike

Material Alumínio

Peso 2660gr - peso da suspensão 100mm

Embalagem 10 peças

21805



AVISOS

USE APENAS PARA:

- LAZER
- CROSS COUNTRY

FOTOS MERAMENTE ILUSTRATIVAS. AS INFORMAÇÕES/CONFIGURAÇÕES DE PRODUTOS PODERÃO SOFRER ALTERAÇÕES SEM AVISO PRÉVIO.

ENTRE EM CONTATO COM O SEU CONSULTOR OU FALE COM O NOSSO TIME DE TELEVENDAS PELO (33) 3277-3030.



## REMOTE DUAL-L 2C-22

Característica	<ul style="list-style-type: none"><li>• Alavanca De Bloqueio Duplo Remoto</li><li>• Construção Em Alumínio</li><li>• Diâmetro 22.2mm</li><li>• Acompanha Cabo Inoxidável</li><li>• Design Ergonômico</li><li>• Abraçadeira Articulada</li><li>• Instalação Do Lado Esquerdo</li><li>• Compatível Com Todos Os Garfos E Shock Sr Suntour</li></ul>
----------------	---

Material	Alumínio
Peso	83g - peso do remote com cabo

Embalagem	10 peças
	21815



## REMOTE SINGLE-U 3C-22

Característica	<ul style="list-style-type: none"><li>• Alavanca De Bloqueio Remoto</li><li>• Construção Em Alumínio</li><li>• Diâmetro 22.2mm</li><li>• Acompanha Cabo Inoxidável</li><li>• Design Ergonômico</li><li>• Abraçadeira Articulada</li><li>• Ambidestra</li><li>• Compatível Com Todos Os Garfos Sr Suntour</li></ul>
----------------	--

Material	Alumínio
Peso	40g - peso do remote com cabo

Embalagem	10 peças
	21817





## REMOTE SINGLE-U 2C-32

Característica	<ul style="list-style-type: none"><li>• Alavanca De Bloqueio Remoto</li><li>• Construção Em Alumínio</li><li>• Diâmetro 31.8mm</li><li>• Acompanha Cabo Inoxidável</li><li>• Design Ergonômico</li><li>• Abraçadeira Articulada</li><li>• Ambidestra</li></ul> Compatível Com Todos Os Garfos Sr Suntour
----------------	--

Material	Alumínio
Peso	43g - peso do remote com cabo
Embalagem	10 peças
	21818



## REMOTE SINGLE-L 2C-22

Característica	<ul style="list-style-type: none"><li>• Alavanca De Bloqueio Remoto</li><li>• Construção Em Alumínio</li><li>• Diâmetro 22.2mm</li><li>• Acompanha Cabo Inoxidável</li><li>• Design Ergonômico</li><li>• Abraçadeira Articulada</li><li>• Instalação Do Lado Esquerdo</li><li>• Compatível Com Todos Os Garfos Sr Suntour</li></ul>
----------------	---

Material	Alumínio
Peso	48g - peso do remote com cabo
Embalagem	10 peças
	21819





## KIT FERRAMENTAS P/ INSTALAÇÃO DE RASPADORES SR SUNTOUR

Característica	<ul style="list-style-type: none"><li>• Medidas disponíveis: 30mm / 32mm / 34mm / 35mm / 36mm / 38mm</li><li>• Mordente em aço para cartucho</li><li>• Acompanha maleta</li></ul>
Material	Alumínio
Peso	2028gr - box completo
Embalagem	10 peças
	23896



## CHAVE ALLEN P/ SUSPENSÃO SR SUNTOUR

Característica

- Comprimento 350mm
- Excelente acabamento
- Disponíveis nas medidas 5mm e 6mm

Material Aço/Plástico

Peso 100gr allen 5mm / 162gr allen 6mm

Embalagem 10 peças

23899- 5 MM

23900- 6 MM



## TORQUÍMETRO SR SUNTOUR

Característica

- Cabeça reversível (direita / esquerda)
- Comprimento total 330mm
- Encaixe 3/8"
- Acompanha um cachimbo 17mm
- Toques de 10 ≤ 110nm

Material Aço de alta resistência

Peso 878gr

Embalagem 10 peças

23892



## CHAVE DE CATRACA REGULÁVEL PARA SUSPENSÃO SR SUNTOR

Característica

- Chome vanadium
- Cabeça reversível (direita / esquerda)
- Pegada reversível emborrachada (direita / esquerda)
- Comprimento total 230mm
- Encaixe 3/8"

Material Cromo

Peso 420gr

Embalagem 10 peças

23889





## PISTÃO SUNTOUR RL-R

Característica	<ul style="list-style-type: none"><li>• Regulagem de preload</li><li>• Acionador da trava remota</li><li>• Código do fabricante fun083-10</li><li>• Compatível com suspensões xcr32 boost air - coil / xcr32 atb air - coil</li></ul>
Material	Aço
Peso	308gr
Embalagem	20 peças
	23553



## PISTÃO SUNTOUR RL-R

Característica	<ul style="list-style-type: none"><li>• Regulagem de preload</li><li>• Acionador da trava remota</li><li>• Código do fabricante fun083-40</li><li>• Compatível com suspensões xcr34 boost air</li></ul>
Material	Aço
Peso	330gr
Embalagem	20 peças
	23554



## PISTÃO SUNTOUR R2C2

Característica	<ul style="list-style-type: none"><li>• Regulagem de preload / retorno</li><li>• Código do fabricante fun087-95</li><li>• Compatível com suspensões Durolux38 boost</li></ul>
Material	Alumínio
Peso	264gr
Embalagem	20 peças
	23557





## PISTÃO SUNTOUR R2C2

Característica	<ul style="list-style-type: none"><li>• Regulagem de preload / retorno</li><li>• Código do fabricante fun087-15</li><li>• Compatível com suspensões rux38 boost</li></ul>
Material	Alumínio
Peso	304gr
Embalagem	20 peças
	23555



## PISTÃO SUNTOUR R2C2

Característica	<ul style="list-style-type: none"><li>• Regulagem de preload / retorno</li><li>• Código do fabricante fun087-85</li><li>• Compatível com suspensões Durolux36 boost</li></ul>
Material	Alumínio
Peso	255gr
Embalagem	20 peças
	23556



## PISTÃO RLRC SUNTOUR

Característica	<ul style="list-style-type: none"><li>• Regulagem de preload / retorno</li><li>• Código do fabricante fun130-55</li><li>• Compatível com suspensões aion36 boost</li></ul>
Material	Alumínio
Peso	224gr
Embalagem	20 peças
	23558



## PISTÃO RLRC SUNTOUR

Característica	<ul style="list-style-type: none"><li>• Regulagem de preload / retorno</li><li>• Código do fabricante fun130-70</li><li>• Compatível com suspensões axon34 boost</li></ul>
Material	Alumínio
Peso	198gr
Embalagem	20 peças
	23559



## PISTÃO RLRC SUNTOUR

Característica	<ul style="list-style-type: none"><li>• Regulagem de preload / retorno</li><li>• Código do fabricante fun130-80</li><li>• Compatível com suspensões axon34 werx / axon34 elite</li></ul>
Material	Alumínio
Peso	179gr
Embalagem	20 peças
	23560



## CHAVE CACHIMBO DA SUSPENSÃO SR SUNTOUR

Característica	<ul style="list-style-type: none"><li>• Chave sextavada</li><li>• Excelente acabamento</li><li>• Disponíveis nas medidas 21mm e 27mm</li><li>• Encaixe de 1/2"</li></ul>
Material	Aço de alta resistência
Peso	140gr chave 27mm / 72gr chave 21mm
Embalagem	50 peças
	23893- 27 MM
	23894- 21 MM



## CHAVE PARA REMOVER PINOS CANTILEVER

Característica	<ul style="list-style-type: none"><li>• Chave para remover pinos de freio</li><li>• Compatível com garfos, suspensões e quadros com pinos rosqueados</li><li>• Cantilever e vbrake</li><li>• Aço</li><li>• Sextavado</li></ul>
Material	Aço
Peso	36GR
Embalagem	100 peças
Fator de venda	1 unidade
	23895



## CHAVE P/ REMOVER AJUSTE DE PRÉ- CARGA SR SUNTOUR

Característica	<ul style="list-style-type: none"><li>• Chave cachimbo</li><li>• Chave sextavada</li><li>• Excelente acabamento</li><li>• Disponíveis nas medidas 21mm e 27mm</li><li>• Encaixe de 1/2"</li></ul>
Material	Nylon
Peso	8gr
Embalagem	50 peças
	23897



FOTOS MERAMENTE ILUSTRATIVAS. AS INFORMAÇÕES/CONFIGURAÇÕES DE PRODUTOS PODERÃO SOFRER ALTERAÇÕES SEM AVISO PRÉVIO.

ENTRE EM CONTATO COM O SEU CONSULTOR OU FALE COM O NOSSO TIME DE TELEVENDAS PELO (33) 3277-3030.

## CHAVE P/ REMOVER AJUSTE DE PRÉ-CARGA SR SUNTOUR

Característica	<ul style="list-style-type: none"><li>• Chave para ajuste pré-carga suntour</li><li>• Ferramenta para remover e instalar pré-carga e cartucho</li><li>• Nylon</li></ul>
Material	Nylon
Peso	8gr
Embalagem	100 unidades
Fator de venda	1 unidade
	23898



## CONJUNTO DA TAMPA DA TRAVA REMOTA SUNTOUR

Característica	<ul style="list-style-type: none"><li>• Conjunto da tampa da trava para suspensão suntour</li><li>• Alumínio / aço / nylon</li><li>• Código do fabricante fke310-05</li><li>• Compatível com suspensão XCR34 Boost I air</li></ul>
Material	Alumínio / aço / nylon
Peso	44gr
Embalagem	100 unidades
Fator de venda	1 unidade
	23465



## CONJUNTO DA TAMPA DA TRAVA REMOTA SUNTOUR

Característica	<ul style="list-style-type: none"><li>• Conjunto da tampa da trava para suspensão suntour</li><li>• Alumínio / aço / nylon</li><li>• Código do fabricante fke310-08</li><li>• Compatível com suspensão xcr32 boost air rlr / xcr32 boost coil rlr / xcr32 atb rlr / xcr32 atb</li></ul>
Material	Alumínio / aço / nylon
Peso	40gr
Embalagem	100 unidades
Fator de venda	1 unidade
	23466





## KIT AJUSTE DO NÚCLEO DO PISTÃO (TRAVA) RLRC SUNTOUR

Característica	<ul style="list-style-type: none"><li>• Conjunto de ajuste da trava da suspensão suntour</li><li>• Alumínio</li><li>• Código do fabricante fke420</li><li>• Compatível com suspensão axon34 werx boost / axon34 elite boost / axon34 boost / aion36 boost</li></ul>
Material	Alumínio
Peso	24gr
Embalagem	100 unidades
Fator de venda	1 unidade
	23469



## CONJUNTO BOTÃO DE AJUSTE R2C2 SUNTOUR

Característica	<ul style="list-style-type: none"><li>• Botão de ajuste para suspensão suntour</li><li>• Alumínio</li><li>• Código do fabricante fke427-03</li><li>• Compatível com suspensão durolux38 boost eq r2c2 / durolux36 boost eq r2c2 / rux38 boost eq r2c2</li></ul>
Material	Alumínio
Peso	12gr
Embalagem	100 unidades
Fator de venda	1 unidade
	23470



## CONJUNTO DA TAMPA DA VÁLVULA DE AJUSTE SUNTOUR

Característica	<ul style="list-style-type: none"><li>• Conjunto regulador de preload para suspensão suntour</li><li>• Nylon</li><li>• Código do fabricante fke009-15</li><li>• Compatível com suspensão xcr32 boost coirl rlr / xcr32 atb rlr</li></ul>
Material	Nylon
Peso	20gr
Embalagem	100 unidades
Fator de venda	1 unidade
	23452



FOTOS MERAMENTE ILUSTRATIVAS. AS INFORMAÇÕES/CONFIGURAÇÕES DE PRODUTOS PODERÃO SOFRER ALTERAÇÕES SEM AVISO PRÉVIO.

ENTRE EM CONTATO COM O SEU CONSULTOR OU FALE COM O NOSSO TIME DE TELEVENDAS PELO (33) 3277-3030.

## PROTETOR PARA-CHOQUE DE GARFO

Característica	<ul style="list-style-type: none"><li>• Protetor para suspensão suntour</li><li>• Borracha</li><li>• Código do fabricante faa426</li><li>• Compatível com suspensão rux38 boost r2c2</li></ul>
Material	Borracha
Peso	16gr
Embalagem	100 unidades
Fator de venda	1 unidade
	23372



## ESPAÇADOR INTERNO DO REBOUND P/ GARFOS SUNTOUR

Característica	<ul style="list-style-type: none"><li>• Espaçador interno suspensão suntour</li><li>• Nylon</li><li>• Código do fabricante fee247</li><li>• Compatível com suspensão xcr32 boost air rlr</li></ul>
Material	Nylon
Peso	4gr
Embalagem	100 unidades
Fator de venda	1 unidade
	23373



## KIT AJUSTE DO NÚCLEO DO PISTÃO

Característica	<ul style="list-style-type: none"><li>• Botão de ajuste para suspensão suntour</li><li>• Nylon</li><li>• Código do fabricante fee256-30</li><li>• Compatível com suspensão durolux36 boost eq r2c2 / rux38 boost eq r2c2</li></ul>
Material	Nylon
Peso	-
Embalagem	100 unidades
Fator de venda	1 unidade
	23374



## SUPOORTE INTERNO P/ GARFOS SUNTOUR

Característica

- Suporte interno suspensão suntour
- Nylon
- Código do fabricante fee798-40
- Compatível com suspensão xcr32 boost coil rlr / xcr32 atb

Material Nylon

Peso 4gr

Embalagem 100 unidades

Fator de venda 1 unidade

23384



## BATENTE INTERNO INFERIOR SUNTOUR

Característica

- Batente interno inferior suspensão suntour
- Nylon
- Código do fabricante fee799-60
- Compatível com suspensão xcr34 boost air

Material Nylon

Peso 9gr

Embalagem 100 unidades

Fator de venda 1 unidade

23385



## BATENTE INTERNO INFERIOR SUNTOUR

Característica

- Batente interno inferior suspensão suntour
- Nylon
- Código do fabricante fee799-70
- Compatível com suspensão xcr32 boost coil rlr / xcr32 atb

Material Nylon

Peso 8gr

Embalagem 100 unidades

Fator de venda 1 unidade

23386



## BATENTE INTERNO INFERIOR SUNTOUR

Característica	<ul style="list-style-type: none"><li>• Batente interno inferior suspensão suntour</li><li>• Nylon</li><li>• Código do fabricante fee799-80</li><li>• Compatível com suspensão xcr32 boost air / xcr32 atb air</li></ul>
----------------	--

Material Nylon

Peso 9gr

Embalagem 100 unidades

Fator de venda 1 unidade

23387



## ESPAÇADOR INTERNO DO REBOUND P/ GARFOS SUNTOUR

Característica	<ul style="list-style-type: none"><li>• Espaçador interno suspensão suntour</li><li>• Nylon</li><li>• Código do fabricante feg184</li><li>• Compatível com suspensão xcr32 boost coil rlr / xcr32 atb</li></ul>
----------------	---

Material Nylon

Peso -

Embalagem 100 unidades

Fator de venda 1 unidade

23405



## BATENTE INTERNO INFERIOR SUNTOUR

Característica	<ul style="list-style-type: none"><li>• Batente interno inferior suspensão suntour</li><li>• Nylon</li><li>• Código do fabricante feg242-10</li><li>• Compatível com suspensão axon34 werx boost eq / axon34 elite boost eq</li></ul>
----------------	---

Material Nylon

Peso 4gr

Embalagem 100 unidades

Fator de venda 1 unidade

23407



## KIT BUCHA REDUTORA SUNTOUR

Característica	<ul style="list-style-type: none"><li>• Bucha redutora suspensão suntour</li><li>• Borracha</li><li>• Código do fabricante feg270</li><li>• Compatível com suspensão aion36 boost</li></ul>
Material	Borracha
Peso	8gr
Embalagem	100 unidades
Fator de venda	1 unidade
	23408



## KIT BUCHA REDUTORA SUNTOUR

Característica	<ul style="list-style-type: none"><li>• Bucha redutora suspensão suntour</li><li>• Borracha</li><li>• Código do fabricante feg270-30</li><li>• Compatível com suspensão durolux38 boost / durolux36 boost</li></ul>
Material	Borracha
Peso	10gr
Embalagem	100 unidades
Fator de venda	1 unidade
	23409



## BATENTE INTERNO INFERIOR SUNTOUR

Característica	<ul style="list-style-type: none"><li>• Batente interno inferior suspensão suntour</li><li>• Nylon</li><li>• Código do fabricante feg360-40</li><li>• Compatível com suspensão axon34 boost rlc</li></ul>
Material	Nylon
Peso	6gr
Embalagem	100 unidades
Fator de venda	1 unidade
	23410



FOTOS MERAMENTE ILUSTRATIVAS. AS INFORMAÇÕES/CONFIGURAÇÕES DE PRODUTOS PODERÃO SOFRER ALTERAÇÕES SEM AVISO PRÉVIO.

ENTRE EM CONTATO COM O SEU CONSULTOR OU FALE COM O NOSSO TIME DE TELEVENDAS PELO (33) 3277-3030.

## BATENTE DO GUIA DA MOLA SUNTOUR

Característica	<ul style="list-style-type: none"><li>• Batente interno inferior suspensão suntour</li><li>• Borracha</li><li>• Código do fabricante fep053-10</li><li>• Compatível com suspensão xcr32 boost coil rlr / xcr32 atb</li></ul>
Material	Borracha
Peso	3gr
Embalagem	100 unidades
Fator de venda	1 unidade
	23418



## BATENTE INTERNO INFERIOR SUNTOUR

Característica	<ul style="list-style-type: none"><li>• Batente interno inferior suspensão suntour</li><li>• Borracha</li><li>• Código do fabricante fep687</li><li>• Compatível com suspensão axon34 werx / axon34 elite boost / axon34 boost</li></ul>
Material	Borracha
Peso	8gr
Embalagem	100 unidades
Fator de venda	1 unidade
	23433



## BATENTE INTERNO INFERIOR SUNTOUR

Característica	<ul style="list-style-type: none"><li>• Batente interno inferior suspensão suntour</li><li>• Borracha</li><li>• Código do fabricante fep687-10</li><li>• Compatível com suspensão axon34 werx boost eq rlr / axon34 elite boost eq rlr</li></ul>
Material	Borracha
Peso	7gr
Embalagem	100 unidades
Fator de venda	1 unidade
	23434



## CONJUNTO DO BOTÃO DE REBOUND SUNTOUR

Característica	<ul style="list-style-type: none"><li>• Botão de ajuste do rebound suntour</li><li>• Nylon</li><li>• Código do fabricante fee845-10</li><li>• Compatível com suspensões xcr34 boost air</li></ul>
Material	Nylon
Peso	2gr
Embalagem	100 unidades
Fator de venda	1 unidade
	23392



## CONJUNTO DO BOTÃO DE REBOUND SUNTOUR

Característica	<ul style="list-style-type: none"><li>• Botão de ajuste do rebound suntour</li><li>• Alumínio</li><li>• Código do fabricante fee923</li><li>• Compatível com suspensões axon34 boost rllc</li></ul>
Material	Alumínio
Peso	4gr
Embalagem	100 unidades
Fator de venda	1 unidade
	23395



## CONJUNTO DO BOTÃO DE REBOUND SUNTOUR

Característica	<ul style="list-style-type: none"><li>• Botão de ajuste do rebound suntour</li><li>• Alumínio</li><li>• Código do fabricante feg494</li><li>• Compatível com suspensões axon34 boost werx rllc / axon34 boost elite / rllc / aion36 boost rllc</li></ul>
Material	Alumínio
Peso	7gr
Embalagem	100 unidades
Fator de venda	1 unidade
	23415



FOTOS MERAMENTE ILUSTRATIVAS. AS INFORMAÇÕES/CONFIGURAÇÕES DE PRODUTOS PODERÃO SOFRER ALTERAÇÕES SEM AVISO PRÉVIO.

ENTRE EM CONTATO COM O SEU CONSULTOR OU FALE COM O NOSSO TIME DE TELEVENDAS PELO (33) 3277-3030.

## CONJUNTO DO BOTÃO DE REBOUND SUNTOUR

Característica	<ul style="list-style-type: none"><li>• Botão de ajuste do rebound suntour</li><li>• Alumínio</li><li>• Código do fabricante feg494-10</li><li>• Compatível com suspensões aion36 boost eq rlr</li></ul>
Material	Alumínio
Peso	8gr
Embalagem	100 unidades
Fator de venda	1 unidade
	23416



## CONJUNTO BOTÃO DE AJUSTE SUNTOUR

Característica	<ul style="list-style-type: none"><li>• Botão de ajuste do rebound suntour</li><li>• Nylon / aço</li><li>• Código do fabricante fka004-22</li><li>• Compatível com suspensões xcr32 boost air rlr / xcr32 boost coil rlr / xcr32 atb rlr / xcr32 atb air rlr</li></ul>
Material	Nylon / aço
Peso	5gr
Embalagem	100 unidades
Fator de venda	1 unidade
	23442



## CONJUNTO DO BOTÃO DE REBOUND SUNTOUR

Característica	<ul style="list-style-type: none"><li>• Botão de ajuste do rebound suntour</li><li>• Alumínio</li><li>• Código do fabricante fke480-02</li><li>• Compatível com suspensões durolux38 boost eq r2c2 / durolux36 boost eq r2c2 / rux38 boost eq r2c2</li></ul>
Material	Alumínio
Peso	6gr
Embalagem	100 unidades
Fator de venda	1 unidade
	23475





## CLIQUE DE CABO DE FREIO - LOWER LEG SUNTOUR

Característica	<ul style="list-style-type: none"><li>• Clipe do cabo de freio suntour</li><li>• Fixação por parafuso na lower leg</li><li>• Nylon</li><li>• Código do fabricante fee797</li><li>• Compatível com suspensões axon34 boost rlr / xcr32 boost air rlr / xcr32 boost coil rlr / xcr32 atb rlr / xcr34 boost air r-2cr / xcr32 atb air rlr</li></ul>
----------------	--

Material	Nylon
Peso	2gr
Embalagem	100 unidades
Fator de venda	1 unidade

23383



## CLIQUE DE CABO DE FREIO - LOWER LEG SUNTOUR

Característica	<ul style="list-style-type: none"><li>• Clipe do cabo de freio suntour</li><li>• Fixação por pressão na lower leg</li><li>• Nylon</li><li>• Código do fabricante feg034</li><li>• Compatível com suspensões durolux38 boost eq r2c2 / durolux36 boost eq r2c2 / axon34 werx boost eq rlr / axon34 elite boost eq rlr / rux38 boost eq r2c2</li></ul>
----------------	--

Material	Nylon
Peso	2gr
Embalagem	100 unidades
Fator de venda	1 unidade

23403



## PARAFUO DO CLIP DE CABO DE FREIO - LOWER LEG SUNTOUR

Característica	<ul style="list-style-type: none"><li>• Parafuso clipe do cabo de freio suntour</li><li>• Fixação na lower leg</li><li>• Aço</li><li>• Código do fabricante fsb153</li><li>• Compatível com suspensões axon34 boost rlr / xcr32 boost air rlr / xcr32 boost coil rlr / xcr32 atb rlr / xcr34 boost air r-2cr / xcr32 atb air rlr</li></ul>
----------------	--

Material	Aço
Peso	2gr
Embalagem	100 unidades
Fator de venda	1 unidade

23542



FOTOS MERAMENTE ILUSTRATIVAS. AS INFORMAÇÕES/CONFIGURAÇÕES DE PRODUTOS PODERÃO SOFRER ALTERAÇÕES SEM AVISO PRÉVIO.

ENTRE EM CONTATO COM O SEU CONSULTOR OU FALE COM O NOSSO TIME DE TELEVENDAS PELO (33) 3277-3030.

## GUIA DE MOLA DA CÂMARA DE ÓLEO SUNTOUR

Característica	<ul style="list-style-type: none"><li>• Guia de mola da câmara de ar suntour</li><li>• Nylon</li><li>• Código do fabricante fee262-40</li><li>• Compatível com suspensão xcr32 boost coil rlr / xcr32 atb rlr</li></ul>
Material	Nylon
Peso	2gr
Embalagem	100 unidades
Fator de venda	1 unidade
	23376



## GUIA DA MOLA DE RECUPERAÇÃO P/ GARFOS SUNTOUR

Característica	<ul style="list-style-type: none"><li>• Guia de mola de recuperação suntour</li><li>• Nylon</li><li>• Código do fabricante fee937</li><li>• Compatível com suspensão xcr32 boost coil rlr / xcr32 atb rlr</li></ul>
Material	Nylon
Peso	2gr
Embalagem	100 unidades
Fator de venda	1 unidade
	23396



## PORCA INTERNA INFERIOR DA CÂMARA DE AR SUNTOUR

Característica	<ul style="list-style-type: none"><li>• Porca interna câmara de ar suntour</li><li>• Alumínio</li><li>• Código do fabricante feg211</li><li>• Compatível com suspensão axon34 boost rlc</li></ul>
Material	Alumínio
Peso	10gr
Embalagem	100 unidades
Fator de venda	1 unidade
	23406



## TAMPA DE CROWN SUNTOUR

Característica	<ul style="list-style-type: none"><li>• Tampa do crown suntour</li><li>• Nylon</li><li>• Fixação por pressão</li><li>• Código do fabricante feg394</li><li>• Compatível com suspensão xcr32 atb air rlr</li></ul>
Material	Nylon
Peso	2gr
Embalagem	100 unidades
Fator de venda	1 unidade
	23411



## MOLA DE RECUPERAÇÃO P/ GARFOS SUNTOUR

Característica	<ul style="list-style-type: none"><li>• Mola de recuperação suntour</li><li>• Aço</li><li>• Código do fabricante fep189-20</li><li>• Compatível com suspensão xcr32 boost coil rlr / xcr32 atb rlr</li></ul>
Material	Aço
Peso	15gr
Embalagem	100 unidades
Fator de venda	1 unidade
	23420



## VÁLVULA DA CÂMARA DE AR SUNTOUR

Característica	<ul style="list-style-type: none"><li>• Válvula da câmara de ar suntour</li><li>• Nylon</li><li>• Código do fabricante fke091-25</li><li>• Compatível com suspensão axon34 boost rlc</li></ul>
Material	Nylon
Peso	2gr
Embalagem	100 unidades
Fator de venda	1 unidade
	23464



FOTOS MERAMENTE ILUSTRATIVAS. AS INFORMAÇÕES/CONFIGURAÇÕES DE PRODUTOS PODERÃO SOFRER ALTERAÇÕES SEM AVISO PRÉVIO.

ENTRE EM CONTATO COM O SEU CONSULTOR OU FALE COM O NOSSO TIME DE TELEVENDAS PELO (33) 3277-3030.

## O'RING EXTERNO DO GARFO SUNTOUR

- Característica
- O'ring externo para suspensão suntour
  - Material borracha
  - Fixado no parafuso de regulagem do rebound na parte inferior da lower leg
  - Compatível com suspensão xcr 34 boost
  - Código fabricante faa083

Material Borracha

Peso 0,02gr

Embalagem 100 unidades

Fator de venda 1 unidade

23368



## O'RING EXTERNO DO GARFO SUNTOUR

- Característica
- O'ring externo para suspensão suntour
  - Material borracha
  - Fixado na haste do garfo
  - Auxilia na regulagem de sag
  - Compatível com suspensão rux38
  - Código fabricante faa397-20

Material Borracha

Peso 0,02gr

Embalagem 100 unidades

Fator de venda 1 unidade

23369



## O'RING EXTERNO DO GARFO SUNTOUR

- Característica
- O'ring externo para suspensão suntour
  - Material borracha
  - Fixado na haste do garfo
  - Auxilia na regulagem de sag
  - Compatível com suspensão axon34 (werx / elite / axon34)
  - Código fabricante faa397-30

Material Borracha

Peso 0,02gr

Embalagem 100 unidades

Fator de venda 1 unidade

23370



## O'RING EXTERNO DO GARFO SUNTOUR

Característica

- O'ring externo para suspensão suntour
- Material borracha
- Fixado na haste do garfo
- Auxilia na regulagem de sag
- Compatível com suspensão durolux36
- Código fabricante faa397-40

Material Borracha

Peso 0,02gr

Embalagem 100 unidades

Fator de venda 1 unidade

23371

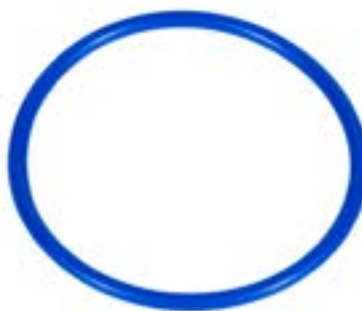

## O'RING EXTERNO DO GARFO SUNTOUR

Característica

- O'ring externo para suspensão suntour
- Material borracha
- Fixado na haste do garfo
- Auxilia na regulagem de sag
- Compatível com suspensão aion36
- Código fabricante feg397-40

Material Borracha

Peso 0,02gr

Embalagem 100 unidades

Fator de venda 1 unidade

23412

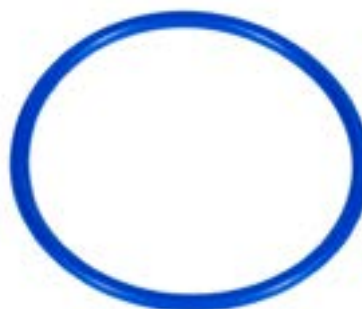

## CONJUNTO DE PARAFUSO DE FIXAÇÃO DO PISTÃO SUNTOUR

Característica

- Parafuso fixação do pistão suntour
- Kit parafuso e arruela
- Aço
- Código do fabricante fka044
- Compatível com suspensões axon34 boost rlr / xcr32 boost air rlr / xcr32 boost coil rlr / xcr32 atb rlr / xcr34 boost air r-2cr / xcr32 atb air rlr

Material Aço

Peso 8gr

Embalagem 100 unidades

Fator de venda 1 unidade

23443



FOTOS MERAMENTE ILUSTRATIVAS. AS INFORMAÇÕES/CONFIGURAÇÕES DE PRODUTOS PODERÃO SOFRER ALTERAÇÕES SEM AVISO PRÉVIO.

ENTRE EM CONTATO COM O SEU CONSULTOR OU FALE COM O NOSSO TIME DE TELEVENDAS PELO (33) 3277-3030.

## CONJUNTO DE PORCAS DE FIXAÇÃO CÂMARA DE AR SUNTOUR

Característica	<ul style="list-style-type: none"><li>• Porca fixação do pistão câmara de ar suntour</li><li>• Kit porca e arruela</li><li>• Alumínio</li><li>• Código do fabricante fka063-03</li><li>• Compatível com suspensões durolux38 boost eq r2c2 / durolux36 boost eq r2c2 / axon34 werx boost eq rlr / axon34 elite boost eq rlr / rux38 boost eq r2c2 / aion36 boost eq rlr</li></ul>
----------------	---

Material Alumínio

Peso 2gr

Embalagem 100 unidades

Fator de venda 1 unidade

23444



## CONJUNTO DE PORCAS DE FIXAÇÃO CÂMARA DE AR SUNTOUR

Característica	<ul style="list-style-type: none"><li>• Porca fixação do pistão suntour</li><li>• Kit porca, arruela e o'ring</li><li>• Alumínio</li><li>• Código do fabricante fke436</li><li>• Compatível com suspensões durolux38 boost eq r2c2 / durolux36 boost eq r2c2 / axon34 werx boost eq rlr / axon34 elite boost eq rlr / rux38 boost eq r2c2 / aion36 boost eq rlr</li></ul>
----------------	---

Material Alumínio

Peso 2gr

Embalagem 100 unidades

Fator de venda 1 unidade

23471



## CONJUNTO DE PORCAS DE FIXAÇÃO CÂMARA DE AR SUNTOUR

Característica	<ul style="list-style-type: none"><li>• Porca fixação do pistão suntour</li><li>• Kit porca, arruela e o'ring</li><li>• Alumínio</li><li>• Código do fabricante fke436-03</li><li>• Compatível com suspensões durolux38 boost eq r2c2 / durolux36 boost eq r2c2 / rux38 boost eq r2c2</li></ul> <p>Referência ficha técnica: durolux38-boost eq r2c2-pcs ds 20lh- 110 29" / durolux36-boost eq r2c2-pcs ds 15qlc2ti-110 29" / rux38-boost eq r2c2-pcs ds t 29"</p>
----------------	--

Material Alumínio

Peso 2gr

Embalagem 100 unidades

Fator de venda 1 unidade

23472



## CONJUNTO DE PORCAS DE FIXAÇÃO CÂMARA DE AR SUNTOUR

Característica	<ul style="list-style-type: none"><li>• Porca fixação do pistão câmara de ar suntour</li><li>• Kit porca, arruela e o'ring</li><li>• Alumínio</li><li>• Código do fabricante fke436-04</li><li>• Compatível com suspensões axon34 werx boost eq rlc / axon34 elite boost eq rlc / aion36 boost eq rlc</li></ul>
----------------	---

Material	Alumínio
Peso	2gr
Embalagem	100 unidades
Fator de venda	1 unidade

23473



## PARAFUSO DE FIXAÇÃO DO AMORTECEDOR (LOWER LEG) SUNTOUR

Característica	<ul style="list-style-type: none"><li>• Parafuso fixação do pistão suntour</li><li>• Aço</li><li>• Código do fabricante fsb058</li><li>• Compatível com suspensões xcr32 boost air rlr / xcr32 boost coil rlr / xcr32 atb rlr / xcr34 boost air r2cr / xcr32 atb air rlr</li></ul>
----------------	--

Material	Aço
Peso	8gr
Embalagem	100 unidades
Fator de venda	1 unidade

23541



## KIT SUPERIOR DA CÂMARA DE AR SUNTOUR

Característica	<ul style="list-style-type: none"><li>• Kit superior da câmara de ar suntour</li><li>• Alumínio</li><li>• Kit completo com o'rings e tampa da válvula</li><li>• Código do fabricante fke075-12</li><li>• Compatível com suspensões xcr32 air</li></ul>
----------------	--

Material	Alumínio
Peso	26gr
Embalagem	50 unidades
Fator de venda	1 unidade

23456



## KIT SUPERIOR DA CÂMARA DE AR SUNTOUR

Característica	<ul style="list-style-type: none"><li>• Kit superior da câmara de ar suntour</li><li>• Alumínio</li><li>• Kit completo com o'rings e tampa da válvula</li><li>• Código do fabricante fke075-47</li><li>• Compatível com suspensões xcr34 air</li></ul>
----------------	--

Material	Alumínio
Peso	30gr
Embalagem	50 unidades
Fator de venda	1 unidade

23457



## KIT SUPERIOR DA CÂMARA DE AR SUNTOUR

Característica	<ul style="list-style-type: none"><li>• Kit superior da câmara de ar suntour</li><li>• Alumínio</li><li>• Kit completo com o'rings</li><li>• Código do fabricante fke075-68</li><li>• Compatível com suspensões axon34 werx e elite</li></ul>
----------------	---

Material	Alumínio
Peso	28gr
Embalagem	50 unidades
Fator de venda	1 unidade

23458



## KIT SUPERIOR DA CÂMARA DE AR SUNTOUR

Característica	<ul style="list-style-type: none"><li>• Kit superior da câmara de ar suntour</li><li>• Alumínio</li><li>• Kit completo com o'rings</li><li>• Código do fabricante fke594-02</li><li>• Compatível com suspensões aion36 - 160mm</li></ul>
----------------	--

Material	Alumínio
Peso	50gr
Embalagem	50 unidades
Fator de venda	1 unidade

23496





## KIT SUPERIOR DA CÂMARA DE AR SUNTOUR

Característica	<ul style="list-style-type: none"><li>• Kit superior da câmara de ar suntour</li><li>• Alumínio</li><li>• Kit completo com o'rings</li><li>• Código do fabricante fke594-02</li><li>• Compatível com suspensões aion36 - 150mm</li></ul>
Material	Alumínio
Peso	56gr
Embalagem	50 unidades
Fator de venda	1 unidade
	23497



## CONJUNTO DA TAMPA DA VÁLVULA SUNTOUR

Característica	<ul style="list-style-type: none"><li>• Tampa da válvula da câmara de ar suntour</li><li>• Plástico</li><li>• Código do fabricante fke076-10</li><li>• Compatível com suspensões xcr32 – xcr34 air</li></ul>
Material	Plástico
Peso	5gr
Embalagem	100 unidades
Fator de venda	1 unidade
	23462



## CONJUNTO DA TAMPA DA VÁLVULA SUNTOUR

Característica	<ul style="list-style-type: none"><li>• Tampa da válvula da câmara de ar suntour</li><li>• Alumínio</li><li>• Código do fabricante fke076-50</li><li>• Compatível com suspensões durolux – rux – axon</li></ul>
Material	Alumínio
Peso	5gr
Embalagem	100 unidades
Fator de venda	1 unidade
	23463



FOTOS MERAMENTE ILUSTRATIVAS. AS INFORMAÇÕES/CONFIGURAÇÕES DE PRODUTOS PODERÃO SOFRER ALTERAÇÕES SEM AVISO PRÉVIO.

ENTRE EM CONTATO COM O SEU CONSULTOR OU FALE COM O NOSSO TIME DE TELEVENDAS PELO (33) 3277-3030.

## CONJUNTO DA TAMPA DA VÁLVULA SUNTOUR

Característica	<ul style="list-style-type: none"><li>• Tampa da válvula da câmara de ar suntour</li><li>• Plástico</li><li>• Código do fabricante fke595</li><li>• Compatível com suspensões aion36</li></ul>
Material	Plástico
Peso	1gr
Embalagem	100 unidades
Fator de venda	1 unidade
	23499





**TRUE<sup>®</sup>**  
**SPORT**



## TRANSBIKE TRUE POP SEM ABRAÇADEIRA

Modelo	TR-40
Característica	Transporta 2 Bicicletas   Sem abraçadeira
Carga Máxima	34 kg
Peso	3 kg
Embalagem	05 peças
	19037

## TRANSBIKE FIRE AÇO COM SEPARADOR COM BORRACHÃO TRUE SPORTS 3 BIKES

Modelo	Transbike do reboque   linha true sports
Material	Aço
Característica	<ul style="list-style-type: none"><li>• Transbike true modelo em "v" da bola do reboque</li><li>• Fitas de fixação reguláveis</li><li>• Base de apoio em borracha com prendedores</li><li>• Construção em aço carbono</li><li>• Pintura epóx</li><li>• Braços retráteis</li><li>• Suporte para 3 bicicletas, sendo: 02 adultas e 01 infantil</li><li>• Trava de segurança</li><li>• Garras com proteção para o veículo</li></ul>
	Medidas 85 x 48 x 52cm
Carga Máxima	45 kg
Peso	4750 kg
Embalagem	01 peças
	22559



FOTOS MERAMENTE ILUSTRATIVAS. AS INFORMAÇÕES/CONFIGURAÇÕES DE PRODUTOS PODERÃO SOFRER ALTERAÇÕES SEM AVISO PRÉVIO.

ENTRE EM CONTATO COM O SEU CONSULTOR OU FALE COM O NOSSO TIME DE TELEVENDAS PELO (33) 3277-3030.



**TRUE**  
SPORT



## RODINHA LATERAL BICICLETA ARO 16 TRUE

Modelo	Roda lateral para bicicleta aro 16   linha true
Material	Aço
Característica	<ul style="list-style-type: none"> <li>• Rodinha lateral p/ bicicleta aro 16"</li> <li>• Haste em aço</li> <li>• Rodinha de nylon rígido</li> <li>• Fixação das haste no eixo traseiro</li> <li>• Fixação das rodinhas por parafuso com porca travante</li> <li>• Trava de segurança para fixação da haste no eixo</li> <li>• Compatível com eixo de 9mm</li> </ul>
Peso	514g (conjunto)
Embalagem	30 peças

	22668		22672
	22669		22673
	22670		22674
	22671		22684



## SUPORTE VERTICAL DE PAREDE TRUE

Modelo	Suporte vertical de parede   linha true
Material	Aço
Característica	<ul style="list-style-type: none"> <li>• Suporte vertical de parede para bicicletas</li> <li>• Aço de alta resistência</li> <li>• Protetor de aro</li> <li>• Acompanha jogo de parafusos e buchas</li> </ul>
Observação	Recomendamos o uso com pneus ≤ 2.20 (Cravo baixo)
Peso	334gr - peso do suporte c/ parafusos e buchas
Embalagem	30 peças

22586



FOTOS MERAMENTE ILUSTRATIVAS. AS INFORMAÇÕES/CONFIGURAÇÕES DE PRODUTOS PODERÃO SOFRER ALTERAÇÕES SEM AVISO PRÉVIO.

ENTRE EM CONTATO COM O SEU CONSULTOR OU FALE COM O NOSSO TIME DE TELEVENDAS PELO (33) 3277-3030.

## TRANSBIKE FIRE ALUMINIO TRUE SPORTS - P/ 2 BIKES

Modelo	Transbike Fire True Sports
Característica	Alumínio Muito leve e resistente Suporte para 02 bicicletas Presilhas para fixação em borracha Base de apoio do carro emborrachada Suporte de regulagem com várias posições
Carga Máxima	45 kg
Peso	2350 kg
Embalagem	05 peças
	22561



### CREMALHEIRA PAR TRUE

Modelo	CREM-001
Característica	Cremalheira par
Embalagem	25 peças

19052



### KIT SUPORTE BORRACHA MODELO 01 TRUE

Modelo	KIT BORR 1
Característica	Para tubos de 1"
Embalagem	25 peças

19053



### KIT SUPORTE BORRACHA MODELO 02 TRUE

Modelo	KIT BORR 2
Característica	Para tubos 7/8
Embalagem	25 peças

19054

FOTOS MERAMENTE ILUSTRATIVAS. AS INFORMAÇÕES/CONFIGURAÇÕES DE PRODUTOS PODERÃO SOFRER ALTERAÇÕES SEM AVISO PRÉVIO.

ENTRE EM CONTATO COM O SEU CONSULTOR OU FALE COM O NOSSO TIME DE TELEVENDAS PELO (33) 3277-3030.



## SUPOORTE HORIZONTAL DE PAREDE SEM ALÇA TRUE

Característica	Ótimo para armazenamento de bicicleta em casa, garagem ou apartamento   Fácil de instalar, construído com aço de alta resistência   Acompanha 3 parafusos e 3 buchas para fixação   Construção em aço carbono e pintura epóx   Contém argola acoplada ao suporte para fixação do cadeado
Composição	Suporta com segurança até 2 bikes, ou peso total de até 30 kg
Embalagem	01 peça
Dimensões	(A x L x C cm): 28x30x50

22552

**TRUE**  
SPORT



## TRANSBIKE ENGATE BOLA C/SEP. TIRA PT TRUE P/ 3 BIKES

Característica	<ul style="list-style-type: none"> <li>• transbike engate true sports</li> <li>• aço</li> <li>• com separador p/ 03 bicicletas</li> <li>• modelo em "v"</li> <li>• braço articulado e retrátil</li> <li>• resistente</li> <li>• fácil instalação</li> <li>• presilhas para fixação em borracha</li> <li>• pintura epóx</li> <li>• peso máximo recomendado 45kg</li> <li>• acompanha fitas e garras para fixação</li> <li>• acompanha manual p/ instalação</li> </ul>
----------------	--

Material	Aço
Embalagem	01 peça
Peso	4.800 kg
Recomendação de uso	<ul style="list-style-type: none"> <li>• transbike para 3 bicicletas: 02 bicicletas adulto e 01 bicicleta infantil</li> <li>• fixado na bola do reboque</li> </ul>

22679



## SUPOORTE HORIZONTAL COM ALÇA TRUE

Característica	Resistente e de fácil manuseio; prático e seguro   Ótimo para armazenamento de bicicleta em casa, garagem ou apartamento   Fácil de instalar, construído com aço de alta resistência   Acompanha 3 parafusos e 3 buchas para fixação   Construção em aço carbono e pintura epóx   Contém argola acoplada ao suporte para fixação do cadeado
Composição	Suporta com segurança até 2 bikes, ou peso total de até 30 kg   Contém duas alças para melhor fixação das bicicletas
Embalagem	01 peça
Dimensões	(A x L x C cm): 28x30x50

22677

22553



FOTOS MERAMENTE ILUSTRATIVAS. AS INFORMAÇÕES/CONFIGURAÇÕES DE PRODUTOS PODERÃO SOFRER ALTERAÇÕES SEM AVISO PRÉVIO.

ENTRE EM CONTATO COM O SEU CONSULTOR OU FALE COM O NOSSO TIME DE TELEVENDAS PELO (33) 3277-3030.





## TRANSBIKES POP SEM SEPARADOR 2 BIKES TRUE

Característica	Contém fitas de fixação já instaladas, modelo pré-montado, facilitando a montagem em seu veículo; todas com uma ótima qualidade, com sistema de fixação por meia argola   Este modelo de Transbike não acompanha separador   Construção em aço carbono e pintura epóx
Composição	4 fitas de fixação com meia argola   Acompanha também mangueira para não riscar o quadro   Suporta 2 bikes ou peso máximo de até 30 kg
Embalagem	01 peça
Dimensões	Largura: 50cm   Profundidade 55 cm   Altura 60 cm

22555



## TRANSBIKE SAPATA 2 BIKES TRUE

Característica	Contém fitas de fixação já instaladas, modelo pré-montado, facilitando a montagem em seu veículo; todas com uma ótima qualidade, com sistema de fixação por meia argola   Este modelo de Transbike acompanha separador   Sapata articulável e base de apoio do veículo em borracha   Construção em aço carbono e pintura epóx
Composição	4 fitas de fixação com meia argola   Acompanha também mangueira para não riscar o quadro   Suporta 2 bikes ou peso máximo de até 30 kg   Alojamento/separador para apoio da bike
Embalagem	01 peça
Dimensões	Profundidade: 55 cm   Altura: 60 cm   Largura: 50 cm

22557



## TRANSBIKE COM SEPARADOR 2 BIKES TRUE

Característica	Contém fitas de fixação já instaladas, modelo pré-montado, facilitando a montagem em seu veículo; todas com uma ótima qualidade, com sistema de fixação por meia argola   Este modelo de Transbike acompanha separador   Construção em aço carbono e pintura epóx
Composição	4 fitas de fixação com meia argola   Acompanha também mangueira para não riscar o quadro   Suporta 2 bikes ou peso máximo de até 30 kg   Alojamento/separador para apoio da bike
Embalagem	01 peça
Dimensões	Largura: 50cm   Profundidade: 55 cm   Altura: 60 cm

22556



## TRANSBIKE FIRE AÇO COM SEPARADOR COM BORRACHÃO 3 BIKES TRUE

Característica	Contém fitas de fixação já instaladas, modelo pré-montado, facilitando a montagem em seu veículo; todas com uma ótima qualidade, com sistema de fixação por meia argola   Este modelo de Transbike acompanha separador   Sapata articulável e base de apoio do veículo em borracha ou espuma   Construção em aço carbono e pintura epóx
Composição	6 fitas de fixação com meia argola   Acompanha também mangueira para não riscar o quadro   Suporta 3 bikes ou peso máximo de até 45 kg   Alojamento/separador para apoio da bike
Embalagem	01 peça
Dimensões	Profundidade: 60 cm   Largura: 45 cm   Altura: 65cm

22558

**TRUE**  
SPORT

## TRANSHBIKE FIRE AÇO C/SEPARADOR C/ ESPUMA TRUE

Característica	<ul style="list-style-type: none"> <li>• transbike fire true sports</li> <li>• aço</li> <li>• com separador p/ 02 ou 3 bicicletas</li> <li>• base de apoio do carro com protetor de espuma</li> <li>• leve e resistente</li> <li>• presilhas para fixação em borracha</li> <li>• suporte de regulagem em várias posições</li> <li>• peso máximo recomendado 45kg p/ transbike p/ 03 bicicletas</li> <li>• peso máximo recomendado 35kg p/ transbike p/ 02 bicicletas</li> </ul>
----------------	---

Material	Aço
Embalagem	01 peça
Peso	3.200 kg

Recomendação de uso	<ul style="list-style-type: none"> <li>• transbike para 3 bicicletas: 02 bicicletas adulto e 01 bicicleta infantil</li> <li>• fixado na tampa do porta-mala"</li> </ul>
---------------------	---

2 BIKES 22675

3 BIKES 22676



## TRANSHBIKE SAPATA C/ SEPARADOR C/ ESPUMA TRUE P/ 2 BIKES

Característica	<ul style="list-style-type: none"> <li>• transbike sapata true sports</li> <li>• aço</li> <li>• com separador p/ 02 bicicletas</li> <li>• base de apoio do carro com protetor de espuma</li> <li>• leve e resistente</li> <li>• presilhas para fixação em borracha</li> <li>• pintura epóx</li> <li>• suporte de regulagem em várias posições</li> <li>• peso máximo recomendado 35kg</li> <li>• acompanha fitas e garras para fixação</li> <li>• acompanha manual p/ instalação</li> </ul>
----------------	---

Material	Aço
Embalagem	01 peça
Peso	2.250kg

Recomendação de uso	<ul style="list-style-type: none"> <li>• fixado na tampa do porta-mala</li> </ul>
---------------------	---

22682

## TRANSHBIKE POP C/SEPARADOR PT C/ES- PUMA TRUE P/ 2 BIKES

Característica	<ul style="list-style-type: none"> <li>• transbike pop true sports</li> <li>• aço</li> <li>• com separador p/ 02 bicicletas</li> <li>• base de apoio do carro com protetor de espuma</li> <li>• leve e resistente</li> <li>• presilhas para fixação em borracha</li> <li>• pintura epóx</li> <li>• suporte de regulagem em várias posições</li> <li>• peso máximo recomendado 35kg</li> <li>• acompanha fitas e garras para fixação</li> <li>• acompanha manual p/ instalação</li> </ul>
----------------	--

Material	Aço
Embalagem	01 peça
Peso	2.400kg

Recomendação de uso	<ul style="list-style-type: none"> <li>• fixado na tampa do porta-mala</li> </ul>
---------------------	---

22683



### TRANSBIKE ENGATE BOLA 3 BIKES TRUE

Característica	Transbike modelo "V"   Contém fitas de fixação já instaladas, modelo pré-montado, facilitando a montagem em seu veículo; todas com uma ótima qualidade, com sistema de fixação por meia argola   Este modelo de Transbike acompanha separador   Sapata articulável e base de apoio do veículo em borracha ou espuma   Construção em aço carbono e pintura epóx   Braços retráteis e com encaixe
Composição	2 fitas de fixação com meia argola   Acompanha também mangueira para não riscar o quadro   Suporta 3 bikes ou peso máximo de até 55 kg   Alojamento/separador para apoio da bike   Trava central com furação para cadeado   Trava inferior com rosca
Embalagem	01 peça
Dimensões	22559



### ROLO DE TREINO TRUE

Característica	Para pessoas até 100kg   Regulagem de altura conforme o aro da bicicleta   Não indicado para eixo passante   Fixação no eixo traseiro   Para aro 26 - 27,5 - 29 - 700 (speed)   Para bicicletas com ou sem blocagem   Construção em aço carbono pintura epóx
Composição	Com 2 rolamentos
Embalagem	01 peça
Dimensões	Altura: 65 cm   Largura: 46cm
	22560



### SUPOTE EXPOSITOR BICICLETA RODA TRASEIRA TRUE

Característica	Suporte confeccionado para roda traseira Construção em aço carbono Revestido com pintura epóx Para bicicletas aro 26" a 29"
Composição	Desencaixe fácil e rápido
Embalagem	01 peça

MODELO 01: 22554  
MODELO 02: 22667





## TRANSBIKE TETO ALUMINIO CALHA P/ 1 BIKE

### Característica

- TRANSBIKE TETO TRUE SPORTS
- ALUMÍNIO
- CALHA REGULÁVEL
- COMPRIMENTO DA CALHA 130CM
- EXCELENTE ACABAMENTO
- BRAÇO ARTICULADO
- RESISTENTE
- FÁCIL INSTALAÇÃO
- PINTURA EPÓX
- ACOMPANHA FITAS E GARRAS PARA FIXAÇÃO
- ACOMPANHA MANUAL P/ INSTALAÇÃO
- COMPATÍVEL COM BICICLETAS ARO 26", 27.5" E 29"
- DISPONÍVEL NAS CORES PRETO E PRATA

### Material

Alumínio

### Embalagem

01 peça

### Recomendação de uso

Instalar no bagageiro superior do carro (Teto)

### Preto

22680

### Prata

22681

FOTOS MERAMENTE ILUSTRATIVAS. AS INFORMAÇÕES/CONFIGURAÇÕES DE PRODUTOS PODERÃO SOFRER ALTERAÇÕES SEM AVISO PRÉVIO.

ENTRE EM CONTATO COM O SEU CONSULTOR OU FALE COM O NOSSO TIME DE TELEVENDAS PELO (33) 3277-3030.



## SUORTE CARAMANHOLA NYLON ROBUST TRUE

Característica	Suporte de caramanhola em nylon   Ótima qualidade e um belo acabamento   Confeccionado em nylon possui leveza e resistência   Fixação com 2 parafusos inox
Composição	Sistema de regulagem com duas posições
Embalagem	01 peça

	22527		22533
	22528		22534
	22529		22535
	22530		22536
	22531		22537
	22532		22538



## SUORTE CARAMANHOLA NYLON / FIBRA VIDRO TRUE

Característica	Suporte de caramanhola moderno e leve   Fixação com 2 parafusos inox. Sistema de regulagem com duas posições
Composição	Confeccionado em fibra de vidro   Formato que reduz a possibilidade da caramanhola sair do suporte em terrenos irregulares   Projetado para que a caramanhola tenha um encaixe simples e suave   Construção em 30% fibra de vidro e 70% nylon
Embalagem	01 peça





	22539		22542
	22540		22543
	22541		22544
			22545





## SUPOORTE CARAMANHOLA NYLON ROBUST



Material	Nylon
Característica	<ul style="list-style-type: none"> <li>• Suporte de caramanhola TRUE</li> <li>• Design moderno</li> <li>• Leve e resistente</li> <li>• Fixação por 02 parafusos (acompanham o suporte)</li> <li>• Sistema de fixação com regulagem de posição</li> <li>• Confeccionado em nylon</li> </ul>
Peso	38gr - peso referente ao suporte com parafusos
Embalagem	100 unidades

-  22527
-  22530
-  22533
-  22537



## SUPOORTE CARAMANHOLA FIBRA CARBONO

Material	Nylon / Carbono
Característica	<ul style="list-style-type: none"> <li>• Suporte de caramanhola true</li> <li>• Design moderno</li> <li>• Leve e resistente</li> <li>• Fixação por 02 parafusos (acompanham o suporte)</li> <li>• Sistema de fixação com regulagem de posição</li> <li>• Confeccionado em nylon e fibra de carbono (70% / 30%)</li> </ul>
Observação:	Confeccionado em fibra de vidro, formato que reduz a possibilidade da caramanhola sair do suporte em terrenos irregulares, projetado para que a caramanhola tenha um encaixe simples e suave, construção em 30% fibra de carbono e 70% nylon.
Peso	32gr - peso referente ao suporte com parafusos
Embalagem	100 unidades

-  22548
-  22550
-  22551



FOTOS MERAMENTE ILUSTRATIVAS. AS INFORMAÇÕES/CONFIGURAÇÕES DE PRODUTOS PODERÃO SOFRER ALTERAÇÕES SEM AVISO PRÉVIO.

ENTRE EM CONTATO COM O SEU CONSULTOR OU FALE COM O NOSSO TIME DE TELEVENDAS PELO (33) 3277-3030.



## SUPORTE CARAMANHOLA FIBRA VIDRO

Material	Nylon / Fibra de Vidro
Característica	<ul style="list-style-type: none"><li>• suporte de caramanhola true</li><li>• design moderno</li><li>• leve e resistente</li><li>• fixação por 02 parafusos (acompanham o suporte)</li><li>• sistema de fixação com regulagem de posição</li><li>• confeccionado em nylon e fibra de vidro (70% / 30%)</li></ul>
Observação:	Confeccionado em fibra de vidro, formato que reduz a possibilidade da caramanhola sair do suporte em terrenos irregulares, projetado para que a caramanhola tenha um encaixe simples e suave, Construção em 30% fibra de vidro e 70% nylon.
Peso	36gr - peso referente ao suporte com parafusos
Embalagem	100 unidades

 22545



**TRUE**  
SPORT



## SUPOORTE CARAMANHOLA NYLON / FIBRA CARBONO TRUE

Característica	Suporte de caramanhola com construção em 30% fibra de carbono e 70% nylon   Fixação com 2 parafusos inox   Sistema de regulagem com duas posições
Composição	Formato que reduz a possibilidade da caramanhola sair do suporte em terrenos irregulares   Projetado para que a caramanhola tenha um encaixe simples e suave   Além de mais leveza e segurança
Embalagem	01 peça

 22546

 22549

 22547

 22550

 22548

 22551



## SAPATA ARTICULÁVEL PAR TRUE



## FITA COM MEIA ARGOLA TRUE

Característica	Fita com sistema de fixação por meia argola
Composição	Material resistente   Fácil instalação   Ganchos com borracha para proteger a lataria do carro
Embalagem	01 peça

22562

Característica	Ponteira de plástico para transbikes   Ponteiros para fixar no suporte de bicicleta   Serve somente para o transbike sapata
Composição	Kit com 02 unidades
Embalagem	01 peça

22563

FOTOS MERAMENTE ILUSTRATIVAS. AS INFORMAÇÕES/CONFIGURAÇÕES DE PRODUTOS PODERÃO SOFRER ALTERAÇÕES SEM AVISO PRÉVIO.

ENTRE EM CONTATO COM O SEU CONSULTOR OU FALE COM O NOSSO TIME DE TELEVENDAS PELO (33) 3277-3030.





### SAPATINHA 7/8 P/ TRANSBIKE TRUE

Característica	Sapatinha fixa   Compatível com modelos (Transbike Pop com separador, Transbike Pop sem separador)
Composição	Kit com 2 unidades
Embalagem	01 peça

22564



### BASE DE APOIO BORRACHÃO TRUE

Característica	Base de apoio para a lata do veículo
Composição	Serve para todos os modelos de transbike em aço
Embalagem	01 peça

22565



### KIT SUPORTE DE 7/8 OU 1 POLEGADA COM TIRA TRUE

Característica	Par de alças de borracha para Transbike 1 polegada   Produto acoplado ao Transbike, para não arrancar o quadro da bicicleta, além de prender o quadro garantindo mais segurança no transporte   Compatíveis com os modelos de transbike para 3 bikes
Composição	Base de separador com tira 1" e 7/8 um   Produto em borracha de excelente qualidade   Material resistente
Embalagem	01 peça

22566

22567



### TIRA PARA SUPORTE PAR TRUE

Característica	Par de alças de borracha para Transbike 1 Polegada   Produto acoplado ao Transbike, para não arrancar o quadro da bicicleta, além de prender o quadro garantindo mais segurança no transporte   Produto em borracha de excelente qualidade   Material resistente
Composição	Compatíveis com os modelos de transbike para 3 bikes
Embalagem	01 peça

22568



FOTOS MERAMENTE ILUSTRATIVAS. AS INFORMAÇÕES/CONFIGURAÇÕES DE PRODUTOS PODERÃO SOFRER ALTERAÇÕES SEM AVISO PRÉVIO.

ENTRE EM CONTATO COM O SEU CONSULTOR OU FALE COM O NOSSO TIME DE TELEVENDAS PELO (33) 3277-3030.



## MANÍPULO 7/8 TRUE

Característica	Catraca com função de abertura e fechamento do transbike
Composição	Produzida para uma melhor angulação no encaixe do transbike no veículo
Embalagem	01 peça

22569



## MANOPLA SOFT PRETA TRUE

Característica	Extremamente confortável, feita totalmente em borracha para uma boa aderência   Proporcionando maciez e maior durabilidade   Cor preta
Composição	Material feito em borracha
Embalagem	01 peça

22526

**TRUE**  
SPORT



## SUPORTE HORIZONTAL DE PAREDE TRUE

Característica	<ul style="list-style-type: none"> <li>• Kit com 3 peças (2 suportes de roda / 1 suporte do pedal)</li> <li>• Material em Aço de Alta qualidade</li> <li>• Apoio das rodas 130mm cada</li> <li>• Acompanha parafusos e buchas para instalação</li> <li>• Possui proteções no suporte do pedal</li> </ul>
Composição	Aço
Peso	661gr - Kit completo sem os parafusos
Embalagem	20 peças

22585



## SUPORTE PNEU DIANTEIRO PARA ROLO DE TREINO

Característica	<ul style="list-style-type: none"> <li>• Suporte para roda dianteira</li> <li>• Estabiliza e nivela a bicicleta</li> <li>• Material leve e resistente</li> <li>• Pezinho em eva</li> </ul>
Composição	Nylon
Peso	226 gr
Embalagem	20 peças

22637

FOTOS MERAMENTE ILUSTRATIVAS. AS INFORMAÇÕES/CONFIGURAÇÕES DE PRODUTOS PODERÃO SOFRER ALTERAÇÕES SEM AVISO PRÉVIO.

ENTRE EM CONTATO COM O SEU CONSULTOR OU FALE COM O NOSSO TIME DE TELEVENDAS PELO (33) 3277-3030.

C A T Á L O G O

**TSTW**



# TCROSS



16"  
WHEELS

 <b>QUADRO</b>	TSW T Cross   Aro 16"   Aço   Caixa over Head Set esferada   Suporte Freio V-Brake   Cabeamento Externo
 <b>GARFO</b>	TSW T-Cross aro 16" Aço   Over Head Set
 <b>SUSPENSÃO TRASEIRA</b>	N/A
 <b>MOVIMENTO DE DIREÇÃO</b>	Caixa de direção Over Head Set esferada
 <b>GUIDÃO</b>	Guidão Cross 22.2 mm   Aço   Possui acessório de Guidão TSW
 <b>SUporte DE GUIDÃO</b>	Alumínio   Over Head Set
 <b>MANOPLA</b>	Nylon
 <b>CONJUNTO DE FREIO</b>	Freio V-Brake de aço   Manete tipo MTB de nylon com reguladores
 <b>DISCO DE FREIO</b>	N/A
 <b>ARO/RAIO</b>	Aro 16"   Alumínio   Folha simples   Preto   Raios zincados
 <b>CUBOS</b>	Cubos em aço   Eixo de 9mm   Com Porca sextavada
 <b>PNEU / CÂMARA DE AR</b>	Pneu: Aro 16 X 2.125" / Câmara: aro 16" Válvula americana
 <b>PEDIVELA</b>	Monobloco   Preto   115 mm Coroa Aço 24D
 <b>CORRENTE</b>	Comum importada   Porta corrente de Nylon
 <b>MOVIMENTO CENTRAL</b>	Movimento central 50 mm esferado

 <b>RODA LIVRE</b>	16 Dentes
 <b>CÂMBIO DIANTEIRO</b>	N/A
 <b>CÂMBIO TRASEIRO</b>	N/A
 <b>ALAVANCA</b>	N/A
 <b>SELIM</b>	Infantil   Preto   Com castanha
 <b>CANOTE</b>	Aço   Medida 25.4 mm
 <b>ABRAÇADEIRA</b>	No quadro   Parafuso
 <b>PEDAL</b>	Infantil   Nylon 1/2 sueco   Preto

16" IMPORTADA

ÚNICO  17406

FOTOS MERAMENTE ILUSTRATIVAS. AS INFORMAÇÕES/CONFIGURAÇÕES DE PRODUTOS PODERÃO SOFRER ALTERAÇÕES SEM AVISO PRÉVIO.

ENTRE EM CONTATO COM O SEU CONSULTOR OU FALE COM O NOSSO TIME DE TELEVENDAS PELO (33) 3277-3030.

# Tcross



16"  
WHEELS

	<b>QUADRO</b>	TSW T Cross   Aro 16"   Aço   Caixa over Head Set esferada   Suporte Freio V-Brake   Cabeamento Externo
	<b>GARFO</b>	TSW T-Cross aro 16" Aço   Over Head Set
	<b>SUSPENSÃO TRASEIRA</b>	N/A
	<b>MOVIMENTO DE DIREÇÃO</b>	Caixa de direção Over Head Set esferada
	<b>GUIDÃO</b>	Guidão Cross 22.2 mm   Aço   Possui acessório de Guidão TSW
	<b>SUPORTE DE GUIDÃO</b>	Alumínio   Over Head Set
	<b>MANOPLA</b>	Nylon
	<b>CONJUNTO DE FREIO</b>	Freio V-Brake de aço   Manete tipo MTB de nylon com reguladores
	<b>DISCO DE FREIO</b>	N/A
	<b>ARO/RAIO</b>	Aro 16"   Alumínio   Folha simples   Preto   Raios zincados
	<b>CUBOS</b>	Cubos em aço   Eixo de 9mm   Com Porca sextavada
	<b>PNEU / CÂMARA DE AR</b>	Pneu: Aro 16 X 2.125" / Câmara: aro 16" Válvula americana
	<b>PEDIVELA</b>	Monobloco   Preto   115 mm Coroa Aço 24D
	<b>CORRENTE</b>	Comum importada   Porta corrente de Nylon
	<b>MOVIMENTO CENTRAL</b>	Movimento central 50 mm esferado

	<b>RODA LIVRE</b>	16 Dentes
	<b>CÂMBIO DIANTEIRO</b>	N/A
	<b>CÂMBIO TRASEIRO</b>	N/A
	<b>ALAVANCA</b>	N/A
	<b>SELIM</b>	Infantil   Preto   Com castanha
	<b>CANOTE</b>	Aço   Medida 25.4 mm
	<b>ABRAÇADEIRA</b>	No quadro   Parafuso
	<b>PEDAL</b>	Infantil   Nylon 1/2 sueco   Preto

16" IMPORTADA

ÚNICO  17407

FOTOS MERAMENTE ILUSTRATIVAS. AS INFORMAÇÕES/CONFIGURAÇÕES DE PRODUTOS PODERÃO SOFRER ALTERAÇÕES SEM AVISO PRÉVIO.

ENTRE EM CONTATO COM O SEU CONSULTOR OU FALE COM O NOSSO TIME DE TELEVENDAS PELO (33) 3277-3030.

TSW

# Tcross

20"  
WHEELS



 **QUADRO** TSW T Cross | Aro 20" | Aço | Caixa over Ahead Set | Seat Tube 22.5 mm | Suporte Freio V-Brake | Cabeamento Externo

 **GARFO** Rígido | Aço | Aro 20" | Espiga Over headset

 **SUSPENSÃO TRASEIRA** N/A

 **MOVIMENTO DE DIREÇÃO** Over Ahead Set | Esfera

 **GUIDÃO** Medida 700 x 21.0 mm | Aço | Bmx

 **SUPORTE DE GUIDÃO** Alumínio | Diâmetro 22.4 mm | Comprimento 40 mm

 **MANOPLA** Borracha

 **CONJUNTO DE FREIO** Traseiro | V-Brake | Aço/Sapata com Parafuso | Preto | Manete Nylon/Alumínio

 **DISCO DE FREIO** N/A

 **ARO/RAIO** Aro 20" | Alumínio | Folha Única | Somente para V-Brake / Raio Aço 2 mm Preto

 **CUBOS** Dianteiro: Aço | 36 furos | Sem Blocação | Somente para V-Brake / Traseiro: Aço | 36 furos | Sem Blocação | Somente para V-Brake | Rosca

 **PNEU / CÂMARA DE AR** Pneu: Aro 20 X 2.1" / Câmara: 20 x 1.95" | Válvula americana

 **PEDIVELA** Braço de Aço 145 mm | Engrenagem Single | 28 Dentes

 **CORRENTE** Single

 **MOVIMENTO CENTRAL** Monobloco | Esferado

 **RODA LIVRE** Single | 16 Dentes | Importado

 **CÂMBIO DIANTEIRO** N/A

 **CÂMBIO TRASEIRO** N/A

 **ALAVANCA** N/A

 **SELIM** Cross | castanha

 **CANOTE** Aço | Medida 22.5 x 250 mm | Sem carinho

 **ABRACADEIRA** No quadro | Parafuso

 **PEDAL** Plataforma | Preto | Nylon

20" IMPORTADA

ÚNICO ■ 17410











FOTOS MERAMENTE ILUSTRATIVAS. AS INFORMAÇÕES/CONFIGURAÇÕES DE PRODUTOS PODERÃO SOFRER ALTERAÇÕES SEM AVISO PRÉVIO.

ENTRE EM CONTATO COM O SEU CONSULTOR OU FALE COM O NOSSO TIME DE TELEVENDAS PELO (33) 3277-3030.

# TCROSS

20"  
WHEELS



 <b>QUADRO</b>	TSW T Cross   Aro 20"   Aço   Caixa over Ahead Set   Seat Tube 22.5 mm   Suporte Freio V-Brake   Cabeamento Externo	 <b>PNEU / CÂMARA DE AR</b>	Pneu: Aro 20 X 2.1" / Câmara: 20 x 1.95"   Válvula americana
 <b>GARFO</b>	Rígido   Aço   Aro 20"   Espiga Over headset	 <b>PEDIVELA</b>	Braço de Aço 145 mm   Engrenagem Single   28 Dentes
 <b>SUSPENSÃO TRASEIRA</b>	N/A	 <b>CORRENTE</b>	Single
 <b>MOVIMENTO DE DIREÇÃO</b>	Over Ahead Set   Esfera	 <b>MOVIMENTO CENTRAL</b>	Monobloco   Esferado
 <b>GUIDÃO</b>	Medida 700 x 21.0 mm   Aço   Bmx	 <b>RODA LIVRE</b>	Single   16 Dentes   Importado
 <b>SUPORTE DE GUIDÃO</b>	Alumínio   Diâmetro 22.4 mm   Comprimento 40 mm	 <b>CÂMBIO DIANTEIRO</b>	N/A
 <b>MANOPLA</b>	Borracha	 <b>CÂMBIO TRASEIRO</b>	N/A
 <b>CONJUNTO DE FREIO</b>	Traseiro   V-Brake   Aço/Sapata com Parafuso   Preto   Manete Nylon/Alumínio	 <b>ALAVANCA</b>	N/A
 <b>DISCO DE FREIO</b>	N/A	 <b>SELIM</b>	Cross   castanha
 <b>ARO/RAIO</b>	Aro 20"   Alumínio   Folha Única   Somente para V-Brake / Raio Aço 2 mm Preto	 <b>CANOTE</b>	Aço   Medida 22.5 x 250 mm   Sem carrinho
 <b>CUBOS</b>	Dianteiro: Aço   36 furos   Sem Blocação   Somente para V-Brake / Traseiro: Aço   36 furos   Sem Blocação   Somente para V-Brake   Rosca	 <b>ABRAÇADEIRA</b>	No quadro   Parafuso
		 <b>PEDAL</b>	Plataforma   Preto   Nylon

20" | IMPORTADA

ÚNICO  17411

FOTOS MERAMENTE ILUSTRATIVAS. AS INFORMAÇÕES/CONFIGURAÇÕES DE PRODUTOS PODERÃO SOFRER ALTERAÇÕES SEM AVISO PRÉVIO.

ENTRE EM CONTATO COM O SEU CONSULTOR OU FALE COM O NOSSO TIME DE TELEVENDAS PELO (33) 3277-3030.

# TSW Posh



16"  
WHEELS



16"  
WHEELS



QUADRO

TSW Posh | Aro 16" | Aço | Porta corrente de aço inteiriço | Roda lateral reforçada e emborrachada | Paralamas de aço com haste | Cestinha retrô nylon | Suporte traseiro de nylon (Cadeirinha para bonecas) | Sinalizador sonoro



GARFO

Aço | Aro 16"



SUSPENSÃO TRASEIRA

N/A



MOVIMENTO DE DIREÇÃO

Standard | Rosca | Esferas



GUIDÃO

Curvo | 25.4 mm | Aço



SUporte DE GUIDÃO

Alumínio | Chanfrado



MANOPLA

Borracha



CONJUNTO DE FREIO

V-Brake | Aço **Manete:** Infantil | Nylon com reguladores



DISCO DE FREIO

N/A



ARO/RAIO

**Aro:** 16" | Aço | Folha simples **Raio:** Aço | Preto



CUBOS

Aço | Eixo 9 mm | Porca sextavada



PNEU / CÂMARA DE AR

**Pneu:** Aro 16" | 2.1125 | Importado  
**Câmara:** Aro 16" | Válvula americana



PEDIVELA

Monobloco | 115 mm | Preto | Coroa aço | 32 D



CORRENTE

Comum | Importada



MOVIMENTO CENTRAL

45 mm | Esferado



RODA LIVRE

16 Dentes



CÂMBIO DIANTEIRO

N/A



CÂMBIO TRASEIRO

N/A



ALAVANCA

N/A



SELIM

Infantil | Castanha | Branco



CANOTE

Aço | 25.4 mm



ABRACADEIRA

N/A



PEDAL

Nylon | Infantil | 1/2 sueco | Branco

16" IMPORTADA SEM CÂMBIO

ÚNICO  18204

ÚNICO  18205

FOTOS MERAMENTE ILUSTRATIVAS. AS INFORMAÇÕES/CONFIGURAÇÕES DE PRODUTOS PODERÃO SOFRER ALTERAÇÕES SEM AVISO PRÉVIO.

ENTRE EM CONTATO COM O SEU CONSULTOR OU FALE COM O NOSSO TIME DE TELEVENDAS PELO (33) 3277-3030.



# Tow Posh



20"  
WHEELS



20"  
WHEELS

	<b>QUADRO</b>	TSW rerô   Aro 20"   Aço   Cesta   Seat tube 22.2mm   Caixa standard   Suporte para freio v-brake   Porta corrente   Descanso lateral
	<b>GARFO</b>	Rígido   Aço   Aro 20"   Espiga standard   Rosca   Suporte para freio v-brake
	<b>SUSPENSÃO TRASEIRA</b>	N/A
	<b>MOVIMENTO DE DIREÇÃO</b>	Standard   Rosca
	<b>GUIDÃO</b>	Passeio   Tropical   Cromado   22.1mm/500mm
	<b>SUPORTE DE GUIDÃO</b>	Caneta   Alumínio   Standard   Espander
	<b>MANOPLA</b>	Borracha
	<b>CONJUNTO DE FREIO</b>	V-Brake   Aço   Sapata   Manete infantil/nylon
	<b>DISCO DE FREIO</b>	N/A
	<b>ARO/RAIO</b>	Aro 20"   Alumínio   Folha Única   36 furos / Raio Aço 2 mm Preto
	<b>CUBOS</b>	Dianteiro: Aço   36 furos   Somente para V-Brake   Esferado / Traseiro: Aço   36 furos   Sem Blocação   Somente para V-Brake   Rosca

	<b>PNEU / CÂMARA DE AR</b>	Pneu: Aro 20"   2.10" / Câmara: Aro 20   1.95"   Válvula americana
	<b>PEDIVELA</b>	Monobloco   140mm / rosca fina   Aço
	<b>CORRENTE</b>	Single
	<b>MOVIMENTO CENTRAL</b>	Monobloco   Esferado
	<b>RODA LIVRE</b>	Single   16 Dentes   Importado
	<b>CÂMBIO DIANTEIRO</b>	N/A
	<b>CÂMBIO TRASEIRO</b>	N/A
	<b>ALAVANCA</b>	N/A
	<b>SELIM</b>	Infantil   Castanha
	<b>CANOTE</b>	Aço   22.5mm/250mm   Cromado
	<b>ABRAÇADEIRA</b>	blocação
	<b>PEDAL</b>	Nylon   Infantil   Rosca fina

20" | IMPORTADA

ÚNICO  18209

ÚNICO  18210

FOTOS MERAMENTE ILUSTRATIVAS. AS INFORMAÇÕES/CONFIGURAÇÕES DE PRODUTOS PODERÃO SOFRER ALTERAÇÕES SEM AVISO PRÉVIO.

ENTRE EM CONTATO COM O SEU CONSULTOR OU FALE COM O NOSSO TIME DE TELEVENDAS PELO (33) 3277-3030.



# TSW retrô

20"  
WHEELS



20"  
WHEELS



20"  
WHEELS



 <b>QUADRO</b>	TSW aço retrô   Aro 20"   Aço   Bagageiro Aço retrô acolchoado   Cestinha nylon retrô   Descanso lateral de aço   Paralamas pintados c/ haste   Campanhia nylon/ aço   Porta corrente aço inteiriço ( cobre toda a parte externa da Transmissão)
 <b>GARFO</b>	Aço P/ V-Brake com rosca
 <b>SUSPENSÃO TRASEIRA</b>	N/A
 <b>MOVIMENTO DE DIREÇÃO</b>	Esferada Standard
 <b>GUIDÃO</b>	Aço Cromado chifre de boi 25.4 mm x 520 mm
 <b>SUORTE DE GUIDÃO</b>	Chanfreado   Alumínio
 <b>MANOPLA</b>	Nylon retrô
 <b>CONJUNTO DE FREIO</b>	V-Brake   Aço   Manetes Nylon com reguladores
 <b>DISCO DE FREIO</b>	N/A
 <b>ARO/RAIO</b>	Aro 20"   Alumínio Preto   Folha simples   28 furos tipo Aero   Raio Aço Preto 2.00 mm X 180 mm

 <b>CUBOS</b>	Aço Preto   28 furos   Eixo maciço com porca
 <b>PNEU / CÂMARA DE AR</b>	Pneu: Aro 20" - 20x2.125
 <b>PEDIVELA</b>	Monobloco   140mm   Aço preto
 <b>CORRENTE</b>	Bronze SLC
 <b>MOVIMENTO CENTRAL</b>	Esferada 45mm
 <b>RODA LIVRE</b>	Bronze 16 Dentes   Importado
 <b>CÂMBIO DIANTEIRO</b>	N/A
 <b>CÂMBIO TRASEIRO</b>	N/A
 <b>ALAVANCA</b>	N/A
 <b>SELIM</b>	Retrô   Castanha
 <b>CANOTE</b>	Aço zincado   25.4 mm x 250 mm
 <b>ABRACADEIRA</b>	blocagem
 <b>PEDAL</b>	Nylon retrô

## 20" | IMPORTADA

- ÚNICO  18211
- ÚNICO  18212
- ÚNICO  18213

FOTOS MERAMENTE ILUSTRATIVAS. AS INFORMAÇÕES/CONFIGURAÇÕES DE PRODUTOS PODERÃO SOFRER ALTERAÇÕES SEM AVISO PRÉVIO.

ENTRE EM CONTATO COM O SEU CONSULTOR OU FALE COM O NOSSO TIME DE TELEVENDAS PELO (33) 3277-3030.

# TSW retrô

16"  
WHEELS



## QUADRO

**Quadro:** TSW Retrô | Aço | Aro 16"  
| **Bagageiro:** Aço retrô acolchoado |  
**Cestinha:** Nylon retrô | **Paralamas:** Aço  
pintados com haste | **Campanhia:** Nylon/  
aço | **Porta corrente:** Aço inteiriço ( cobre  
toda a parte externa da transmissão) |  
**Roda lateral:** Estilo retrô com suporte em  
aço



## GARFO

Aço P/ V-Brake com rosca



## SUSPENSÃO TRASEIRA

N/A



## MOVIMENTO DE DIREÇÃO

Esferada Standard



## GUIDÃO

Aço Cromado chifre de boi | 25.4 mm x  
520 mm



## SUPORE DE GUIDÃO

Chanfreado | Alumínio



## MANOPLA

Nylon retrô



## CONJUNTO DE FREIO

V-Brake | Aço | Preto | **Manete:** Nylon com  
reguladores



## DISCO DE FREIO

N/A



## ARO/RAIO

**Aro:** 16" | Alumínio | Preto | 28 furos tipo  
Aero | Folha simples | **Raio:** Aço Preto  
2.00 mm X 135 mm



## CUBOS

Aço Preto | 28 furos | Eixo maciço com  
porca



## PNEU / CÂMARA DE AR

**Pneu:** Aro 16" - 16 x 2.125 | Importado



## PEDIVELA

Monobloco | 115mm | Aço | Preto



## CORRENTE

Bronze SLC | Importado



## MOVIMENTO CENTRAL

Esferada 45mm



## RODA LIVRE

Bronze 16 Dentes | Importado



## CÂMBIO DIANTEIRO

N/A



## CÂMBIO TRASEIRO

N/A



## ALAVANCA

N/A



## SELIM

Retrô | Castanha



## CANOTE

Aço zincado | 25.4 mm x 200 mm



## ABRAÇADEIRA

N/A



## PEDAL

Nylon retrô 1/2

## 16" | IMPORTADA

ÚNICO  18206

ÚNICO  18207

ÚNICO  18208

FOTOS MERAMENTE ILUSTRATIVAS. AS INFORMAÇÕES/CONFIGURAÇÕES DE PRODUTOS PODERÃO SOFRER ALTERAÇÕES SEM AVISO PRÉVIO.

ENTRE EM CONTATO COM O SEU CONSULTOR OU FALE COM O NOSSO TIME DE TELEVENDAS PELO (33) 3277-3030.

# U.bend

20"  
WHEELS



ACESSÓRIOS E COMPONENTES

 <b>QUADRO</b>	Aro 20"   Alumínio   Dobrável   Trava de segurança na articulação   Lugar para Suporte de Caramanhola   Pivotes para adaptação de Garupas   Caixa de Direção Mega Over   Freio a Disco   Descanso lateral   Urbano	 <b>PEDIVELA</b>	Engrenagem coroa única de 46 dentes   Aço   Braço de aço 165 mm   Guia de corrente em nylon na coroa
 <b>GARFO</b>	Rígido   Aço   Aro 20"   Espiga Over Rosca   Freio a Disco	 <b>CORRENTE</b>	7 velocidades   Index
 <b>SUSPENSÃO TRASEIRA</b>	N/A	 <b>MOVIMENTO CENTRAL</b>	34.7 mm   Rolamentado   Eixo ponta quadrada
 <b>MOVIMENTO DE DIREÇÃO</b>	Mega Over   Caixa semi-integrada   Esfera	 <b>RODA LIVRE</b>	Shimano   7 velocidades   Index   MF-TZ500/7
 <b>GUIDÃO</b>	Alumínio   Formato em T   Tubo 28.6 mm com guia	 <b>CÂMBIO DIANTEIRO</b>	N/A
 <b>SUporte DE GUIDÃO</b>	Alumínio   Trava de Segurança na articulação   Abraçadeira de Alumínio para Regulagem da altura do Guidão   Tubo 25,4 mm chanfrado	 <b>CÂMBIO TRASEIRO</b>	Shimano   7 velocidades   Index   RD-TY200
 <b>MANOPLA</b>	Borracha	 <b>ALAVANCA</b>	Shimano   Revoshift 7 velocidades   Modelo SL-RS35
 <b>CONJUNTO DE FREIO</b>	Disco   Mecânico   Alumínio   Manete com abraçadeira de nylon e alavanca de alumínio	 <b>SELIM</b>	MTB com castanha
 <b>DISCO DE FREIO</b>	Aço   160 mm   6 parafusos	 <b>CANOTE</b>	Alumínio   31.6 x 500 mm   Sem carrinho
 <b>ARO/RAIO</b>	Aro 20"   Alumínio   Parede dupla   Com CNC / Raio preto   Aço   2.0 mm	 <b>ABRAÇADEIRA</b>	Alumínio   Com blocagem
 <b>CUBOS</b>	Dianteiro: Alumínio   Esferado   Blocagem   Freio a disco / Traseiro: Alumínio   Esferado   Blocagem   Freio a disco   Rosca	 <b>PEDAL</b>	Plataforma   Preto   Nylon
 <b>PNEU / CÂMARA DE AR</b>	Pneu: Aro 20"   20 x 1.75"   Chaoyang / Câmara: Chaoyang   Válvula americana	 <b>URBANA</b>	✓
		 <b>CICLOTURISMO</b>	X
		 <b>TRILHAS INTERMEDIÁRIAS</b>	X
		 <b>COMPETIÇÃO</b>	X
		 <b>PESO APROXIMADO</b>	12.51 kg

20" | IMPORTADA

ÚNICO  18069

FOTOS MERAMENTE ILUSTRATIVAS. AS INFORMAÇÕES/CONFIGURAÇÕES DE PRODUTOS PODERÃO SOFRER ALTERAÇÕES SEM AVISO PRÉVIO.













ENTRE EM CONTATO COM O SEU CONSULTOR OU FALE COM O NOSSO TIME DE TELEVENDAS PELO (33) 3277-3030.

# U.bend



20"  
WHEELS

ACESSÓRIOS E COMPONENTES

 <b>QUADRO</b>	Aro 20"   Alumínio   Dobrável   Trava de segurança na articulação   Lugar para Suporte de Caramanholas   Pivores para adaptação de Garupas   Caixa de Direção Mega Over   Freio a Disco   Descanso lateral   Urbano
 <b>GARFO</b>	Rígido   Aço   Aro 20"   Espiga Over Rosca   Freio a Disco
 <b>SUSPENSÃO TRASEIRA</b>	N/A
 <b>MOVIMENTO DE DIREÇÃO</b>	Mega Over   Caixa semi-integrada   Esfera
 <b>GUIDÃO</b>	Alumínio   Formato em T   Tubo 28.6 mm com guia
 <b>SUPOORTE DE GUIDÃO</b>	Alumínio   Trava de Segurança na articulação   Abraçadeira de Alumínio para Regulação da altura do Guidão   Tubo 25,4 mm chanfrado
 <b>MANOPLA</b>	Borracha
 <b>CONJUNTO DE FREIO</b>	Disco   Mecânico   Alumínio   Manete com abraçadeira de nylon e alavanca de alumínio
 <b>DISCO DE FREIO</b>	Aço   160 mm   6 parafusos
 <b>ARO/RAIO</b>	Aro 20"   Alumínio   Parede dupla   Com CNC / Raio preto   Aço   2.0 mm
 <b>CUBOS</b>	Dianteiro: Alumínio   Esferado   Bloagem   Freio a disco / Traseiro: Alumínio   Esferado   Bloagem   Freio a disco   Rosca
 <b>PNEU / CÂMARA DE AR</b>	Pneu: Aro 20"   20 x 1.75"   Chaoyang / Câmara: Chaoyang   Válvula americana

 <b>PEDIVELA</b>	Engrenagem coroa única de 46 dentes   Aço   Braço de aço 165 mm   Guia de corrente em nylon na coroa
 <b>CORRENTE</b>	7 velocidades   Index
 <b>MOVIMENTO CENTRAL</b>	34.7 mm   Rolamentado   Eixo ponta quadrada
 <b>RODA LIVRE</b>	Shimano   7 velocidades   Index   MF-TZ500/7
 <b>CÂMBIO DIANTEIRO</b>	N/A
 <b>CÂMBIO TRASEIRO</b>	Shimano   7 velocidades   Index   RD-TY200
 <b>ALAVANCA</b>	Shimano   Revoshift 7 velocidades   Modelo SL-RS35
 <b>SELIM</b>	MTB com castanha
 <b>CANOTE</b>	Alumínio   31.6 x 500 mm   Sem carrinho
 <b>ABRAÇADEIRA</b>	Alumínio   Com blocagem
 <b>PEDAL</b>	Plataforma   Preto   Nylon
 <b>URBANA</b>	✓
 <b>CICLOTURISMO</b>	X
 <b>TRILHAS INTERMEDIÁRIAS</b>	X
 <b>COMPETIÇÃO</b>	X
 <b>PESO APROXIMADO</b>	12.51 kg

20" | IMPORTADA

ÚNICO ■ 18070

FOTOS MERAMENTE ILUSTRATIVAS. AS INFORMAÇÕES/CONFIGURAÇÕES DE PRODUTOS PODERÃO SOFRER ALTERAÇÕES SEM AVISO PRÉVIO.

ENTRE EM CONTATO COM O SEU CONSULTOR OU FALE COM O NOSSO TIME DE TELEVENDAS PELO (33) 3277-3030.

# Motion

ACESSÓRIOS E COMPONENTES



12"  
WHEELS



 **QUADRO** TSW Motion | Balance | Aro 12" | Alumínio 6061

 **GARFO** TSW | Rígido | Aro 12" | Alumínio

 **CAIXA DE DIREÇÃO** Mega Over | Head Set | Semi-Integrado | Esferado

 **GUIDÃO** TSW | Alumínio | Reto | 25.4 x 400 mm

 **SUPORTE DE GUIDÃO** TSW | Alumínio | 60 mm/7°

 **MANOPLA** Borracha

 **CONJUNTO DE FREIO** Tambor | Maçaneta de Nylon

 **ARO/RAIO** Aro: Aço | 12" / Raio: Preto | 2.0 mm

 **CUBOS** Aço com esfera | Eixo de 9 mm

 **PNEU / CÂMARA DE AR** Pneu SLIN | 12 x 2.25" / Câmara com válvula americana

 **CANOTE** Aço | 22 mm | Selim integrado

 **ABRAÇADEIRA** Alumínio | Blocagem

## IMPORTADA

12"  17397

12"  17401

12"  17400



FOTOS MERAMENTE ILUSTRATIVAS. AS INFORMAÇÕES/CONFIGURAÇÕES DE PRODUTOS PODERÃO SOFRER ALTERAÇÕES SEM AVISO PRÉVIO.

ENTRE EM CONTATO COM O SEU CONSULTOR OU FALE COM O NOSSO TIME DE TELEVENDAS PELO (33) 3277-3030.



## CAPACETES TSW TEAM II

ABERTURAS DE CIRCULAÇÃO DE AR 17

CONSTRUÇÃO/ESTRUTURA Design aerodinâmico | In mold | Estrutura interna em Armor Frame

SISTEMA DE FECHAMENTO Fivela | Com espuma removível e lavável

SISTEMA REGULÁVEL Fivela e dial giratório para melhor encaixe na cabeça

ENCHIMENTO Espuma | Com espuma removível e lavável

TAMANHO 56-61

PESO 257g

1  24896

2  24897

3  24898



  
**ARMOR  
FRAME**



## CAPACETES TSW TEAM III

ABERTURAS DE CIRCULAÇÃO DE AR 22

CONSTRUÇÃO/ESTRUTURA Design moderno | In mold | Estrutura interna em Armor Frame

SISTEMA DE FECHAMENTO Fivela

SISTEMA REGULÁVEL Fivela e Dial giratório para melhor encaixe na cabeça

ENCHIMENTO Espuma | Removível e lavável

TAMANHO 54-59

PESO 241g

1  24899

2  24900

3  24901



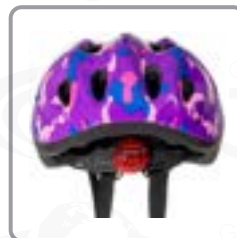

## CAPACETE TSW MTB KIDS II

ABERTURAS DE CIRCULAÇÃO DE AR 12

CONSTRUÇÃO/ESTRUTURA Estrutura robusta | Leve | Máxima proteção e conforto

SISTEMA DE FECHAMENTO Fivela

SISTEMA REGULÁVEL Fivela e Dial giratório para melhor encaixe na cabeça

ENCHIMENTO Espuma | Removível e lavável

SINALIZAÇÃO Com LED vermelho

PESO 188g

1  24968

2  24967

3  24969

4  24971

5  24970

6  24972

## ESPUMA INTERNA para capacete MTB ENDURO

**CARACTERÍSTICA** Espuma interna para capacete MTB Enduro

**EMBALAGEM** 5 peças

11133



## ESPUMA INTERNA para capacete KIDS

**CARACTERÍSTICA** Espuma interna para capacete KIDS

**EMBALAGEM** 5 peças

07488



## ESPUMA INTERNA Capacete RAPTOR

**CARACTERÍSTICA** Kit espuma interna para capacete

**PESO** 10gr

**EMBALAGEM** 50 peças

19055



## VISEIRA CAPACETE RAPTOR III

**CARACTERÍSTICA** Para ajuste de capacete modelo RAPTOR II e III

**MATERIAL** Nylon

**PESO** 15gr

**EMBALAGEM** 50 peças

19056



## CARNEIRA PLÁSTICA para capacete RAPTOR NEW

**CARACTERÍSTICA** Para ajuste de capacete com led

**MATERIAL** Nylon

**PESO** 20gr

**EMBALAGEM** 50 peças

19057





## LUVA MTB COMBAT DM

### Luva MTB Ciclista DM | Modelo 01

**CARACTERÍSTICA** Luvas de alto desempenho e tecnologia inovadora | Super durável | Costas de alta elasticidade para conforto | Pulso super ajustado com velcro

**COMPOSIÇÃO** 40% Poliéster | 30% Poliuretano | 20% Nylon | 10% Elastano

**PESO** 46 gr com a TAG

**EMBALAGEM** 50 peças



PALMA

P		
1		19591
2		19592
3		19593
4		19594
5		19595
6		20006
7		20007
8		20008

M		
1		19586
2		19587
3		19588
4		19589
5		19590
6		20003
7		20004
8		20005

G		
1		19581
2		19582
3		19583
4		19584
5		19585
6		20000
7		20001
8		20002

GG		
1		19575
2		19576
3		19577
5		19578
6		19997
7		19998
8		19999



1



2



3



4

**LUVA MTB COMP GEL DM**  
Luva MTB Ciclista DM | Modelo 02

**CARACTERÍSTICA** Luvas de alto desempenho, com gel e tecnologia inovadora | Super durável | Costas de alta elasticidade para conforto | Pulso super ajustado com velcro

**COMPOSIÇÃO** 60% Nylon | 30% Poliuretano | 10% Elastano

**PESO** 54 gr com a TAG

**EMBALAGEM** 50 peças



PALMA

P		
1		19608
2		19609
3		19610
4		19611

M		
1		19604
2		19605
3		19606
4		19607

G		
1		19600
2		19601
3		19602
4		19603

GG		
1		19596
2		19597
3		19598
4		19599

FOTOS MERAMENTE ILUSTRATIVAS. AS INFORMAÇÕES/CONFIGURAÇÕES DE PRODUTOS PODERÃO SOFRER ALTERAÇÕES SEM AVISO PRÉVIO.

ENTRE EM CONTATO COM O SEU CONSULTOR OU FALE COM O NOSSO TIME DE TELEVENDAS PELO (33) 3277-3030.



1



2



3



4



5

## LUVA MTB COMP DM

### Luva MTB Ciclista DM | Modelo 03

**CARACTERÍSTICA** Luvas de alto desempenho e tecnologia inovadora | Super durável | Costas de alta elasticidade para conforto | Pulso super ajustado com velcro

**COMPOSIÇÃO** 60% Nylon | 30% Poliuretano | 10% Elastano

**PESO** 46 gr com a TAG

**EMBALAGEM** 50 peças



PALMA

P		
1		19628
2		19629
3		19630
4		19631
5		19632

M		
1		19623
2		19624
3		19625
4		19626
5		19627

G		
1		19618
2		19619
3		19620
4		19621
5		19622

GG		
1		19612
2		19613
3		19614
4		19615
5		19617



1



2



3



4

ACESSÓRIOS E COMPONENTES



## LUVA MTB COMP GEL DM

### Luva MTB Ciclista DM | Modelo 04

**CARACTERÍSTICA** Luvas de alto desempenho, com gel e tecnologia inovadora | Super durável | Costas de alta elasticidade para conforto | Pulso super ajustado com velcro

**COMPOSIÇÃO** 60% Nylon | 30% Poliuretano | 10% Elastano

**PESO** 54 gr com a TAG

**EMBALAGEM** 50 peças

P		
1		19645
2		19646
3		19647
4		19648

M		
1		19641
2		19642
3		19643
4		19644

G		
1		19637
2		19638
3		19639
4		19640

GG		
1		19633
2		19634
4		19636

FOTOS MERAMENTE ILUSTRATIVAS. AS INFORMAÇÕES/CONFIGURAÇÕES DE PRODUTOS PODERÃO SOFRER ALTERAÇÕES SEM AVISO PRÉVIO.

ENTRE EM CONTATO COM O SEU CONSULTOR OU FALE COM O NOSSO TIME DE TELEVENDAS PELO (33) 3277-3030.



## LUVA MTB COMP PRO GEL DM Luva MTB Ciclista DM | Modelo 06

**CARACTERÍSTICA** Luvas de alto desempenho, com gel e tecnologia inovadora | Super durável | Costas de alta elasticidade para conforto | Pulso super ajustado com velcro

**COMPOSIÇÃO** 60% Nylon | 30% Poliuretano | 10% Elastano

**PESO** 64 gr com a TAG

**EMBALAGEM** 50 peças

P		
1		19681
2		19682
3		19683
4		19684
5		19685

M		
1		19676
2		19677
3		19678
4		19679
5		19680

G		
1		19671
2		19672
3		19673
4		19674

GG		
1		19667
2		19668
3		19669
4		19670





## LUVA MTB COMP PRO DL

### Luva MTB Ciclista DL | Modelo 05

**CARACTERÍSTICA** Luvas de alto desempenho e tecnologia inovadora | Dedo antiderrapante | Super durável | Costas de alta elasticidade para conforto | Pulso super ajustado com velcro

**COMPOSIÇÃO** 60% Nylon | 30% Poliuretano | 10% Elastano

**PESO** 66 gr com a TAG

**EMBALAGEM** 50 peças

P		
1		19664
2		19665
3		19666

M		
1		19661
2		19662
3		19663

G		
1		19658
2		19659
3		19660

GG		
1		19655
2		19656
3		19657



## LUVA MTB COMP LIGHT DL

### Luva MTB Ciclista DL | Modelo 07

**CARACTERÍSTICA** Luvas de alto desempenho e tecnologia inovadora | Dedo antiderrapante | Super durável | Costas de alta elasticidade para conforto | Pulso super ajustado com velcro | Tecido furado permitindo uma ótima ventilação | Dedo longo | Toalha na parte superior do polegar

**COMPOSIÇÃO** 60% Nylon | 30% Poliuretano | 10% Elastano

**PESO** 50 gr com a TAG

**EMBALAGEM** 50 peças

P		
1		19983
2		19984

M		
1		19985
2		19986
3		19987
4		19988

G		
2		19989
3		19990
4		19992

GG		
2		19993
3		19994
4		19995





1



2



3



4



5



6

## LUVA MTB COMP KIDS

### Luva MTB Ciclista DM | KIDS

**CARACTERÍSTICA** Luvas de alto desempenho e tecnologia inovadora | Super durável | Costas de alta elasticidade para conforto | Pulso super ajustado com velcro

**COMPOSIÇÃO** 40% Poliéster | 30% Poliuretano | 20% Nylon | 10% Elastano

**PESO** 36 gr com a TAG

**EMBALAGEM** 50 peças

PP

1		19649	4		19652
---	--	-------	---	--	-------

2		19650	5		19653
---	--	-------	---	--	-------

3		19651	6		19654
---	--	-------	---	--	-------



PALMA

## MEIA CICLISMO RIDE MOD.01 SUAVE COMPRESSÃO PT

<b>CARACTERÍSTICA</b>	Tamanho único
<b>TAMANHO</b>	39-43
<b>MODALIDADE</b>	Speed e MTB
<b>COMPRESSÃO</b>	Suave
<b>MATERIAL</b>	Poliéster
<b>PESO</b>	60g
<b>EMBALAGEM</b>	10 peças

■ 23675



## MEIA CICLISMO RIDE MOD.02 SUAVE COMPRESSÃO PT

<b>CARACTERÍSTICA</b>	Tamanho único
<b>TAMANHO</b>	39-43
<b>MODALIDADE</b>	Speed e MTB
<b>COMPRESSÃO</b>	Suave
<b>MATERIAL</b>	Poliéster
<b>PESO</b>	60g
<b>EMBALAGEM</b>	10 peças

■ 23676



## MEIA CICLISMO RIDE MOD.04 SUAVE COMPRESSÃO PT/LJ

<b>CARACTERÍSTICA</b>	Tamanho único
<b>TAMANHO</b>	39-43
<b>MODALIDADE</b>	Speed e MTB
<b>COMPRESSÃO</b>	Suave
<b>MATERIAL</b>	Poliéster
<b>PESO</b>	60g
<b>EMBALAGEM</b>	10 peças





■ 23677





**MEIA CICLISMO RIDE MOD.05  
SUAVE COMPRESSÃO**

<b>CARACTERÍSTICA</b>	Tamanho único
<b>TAMANHO</b>	39-43
<b>MODALIDADE</b>	Speed e MTB
<b>COMPRESSÃO</b>	Suave
<b>MATERIAL</b>	Poliéster
<b>PESO</b>	60g
<b>EMBALAGEM</b>	10 peças

- 01  23678
- 02  23679
- 03  23680
- 04  23681

## TRAVA MTB pino Inferior

<b>CARACTERÍSTICA</b>	Trava pino para solado de sapatilha
<b>MODELOS COMPATIVÉIS</b>	Beauty, Cave e Hard

05270



## TRAVA C/ REGULAGEM p/ sapatilhas (catraca)

<b>CARACTERÍSTICA</b>	Trava tsw para sapatilha Regulagem através de catraca Potão para liberação rápida Design moderno Fixação por parafuso
<b>MATERIAL</b>	Nylon
<b>PESO</b>	20 g
<b>EMBALAGEM</b>	100 unidades

4697



## BONÉ ABA RETA (Bordado)

<b>CARACTERÍSTICA</b>	Fecho de velcro   Aba Retá
<b>EMBALAGEM</b>	50 peças
<b>FATOR</b>	2

1  17863

2  17864



1

2



**CAMISA T-DRY**

**CARACTERÍSTICA** Dispersão do calor  
 Mantém a hidratação da pele  
 Retarda a exaustão - Visual opaco  
 Toque especialmente frio  
 Ação antibactericida  
 Proteção a raios UV

**MATERIAL** Poliamida

**EMBALAGEM** 1 peça

**TAMANHO**

PP  20471

**TAMANHO**

P  20472

**TAMANHO**

M  20473

**TAMANHO**

G  20474

**TAMANHO**

GG  20475



**CAMISA T-DRY | CINZA CHUMBO/CORES**

**CARACTERÍSTICA** Dispersão do calor  
Mantém a hidratação da pele  
Retarda a exaustão - Visual opaco  
Toque especialmente frio  
Ação antibactericida  
Proteção a raios UV

**MATERIAL** Poliamida

**EMBALAGEM** 1 peça

TAMANHO	TAMANHO	TAMANHO	TAMANHO	TAMANHO
PP  15804	PP  18499	PP  18505	PP  18527	PP  18528
P  15805	P  18501	P  18506	P  18508	P  18512
M  15806	M  18502	M  18507	M  18509	M  18513
G  15807	G  18503		G  18510	G  18514
GG  15808	GG  18504		GG  18511	GG  18515



### CAMISA CASUAL T-DRY MOD. 01 FLUOR TSW

#### CARACTERÍSTICA

- Camisa casual t-dry mod. 01 Tsw
- Dispensão de calor
- Retarda a exaustão – visual opaco
- Ação bactericida
- Poliamida
- Mantém a hidratação da pele
- Toque especialmente frio
- Proteção contra raios uv
- Tamanhos disponíveis pp/p/m/g/gg

#### MATERIAL

100% Poliamida

#### EMBALAGEM

1 peça

#### TAMANHO

PP  24261

P  24262

M  24263

G  24264

GG  24265





## EXPOSITOR para BIKE PAREDE

**CARACTERÍSTICA** Kit com 3 peças ( 2 suportes de roda / 1 suporte do pedal) | Material em Aço de Alta qualidade | Apoio das rodas 115mm cada | Acompanha parafusos e buchas para instalação

**MATERIAL** Aço

**PESO** 579Gr - Kit completo sem os parafusos

**EMBALAGEM** 1 peça

20577



## EXPOSITOR para 5 BICICLETAS

**CARACTERÍSTICA** Tsw | Até 5 Bicicletas  
Material: Aço | Suporte de Fixação no Pedivela (Parafuso com "borboleta")  
Altura: 8,5 cm x 70,5 cm (Mínima x Máxima) | Comprimento da plataforma: 134 cm  
Largura da plataforma: 6,5 cm | Comprimento do Suporte: 196 cm

**MATERIAL** Aço

**PESO** 15.600 gr

**EMBALAGEM** 1 peça

20573



## EXPOSITOR para 3 BICICLETAS

<b>CARACTERÍSTICA</b>	Tsw   Até 3 Bicicletas Material: Aço   Suporte de Fixação no Pedivela (Parafuso com "borboleta")   Altura: 8,5 cm x 61 cm (Mínima x Máxima)   Comprimento da plataforma: 134 cm Largura da plataforma: 6,5 cm   Comprimento do Suporte (Profundidade): 118 cm
<b>MATERIAL</b>	Aço
<b>PESO</b>	9.100 gr
<b>EMBALAGEM</b>	1 peça
	20572







### PROTETOR TRUCKPAD 2 bikes

#### CARACTERÍSTICA

Costuras reforçadas e ainda conta com presilhas reguláveis para fixação na tampa traseira | Possui fitas auto colantes para fixação da bike, tornando o transporte muito mais seguro | Carrega com segurança até 2 bikes | Tecido especial em lona resinada e tripla proteção E.V.A interna | Protege completamente contra arranhões | Preto

#### DIMENSÕES

Medição com produto aberto sobre a mesa: 0,55m (largura) x 0,70m (comprimento)

Medição com produto colocado no veículo: 0,55m (largura) x 0,35m (altura)

#### EMBALAGEM

1 peça

21327



### TRUCKPAD grande Modelo 03

#### CARACTERÍSTICA

Transporte de até 5 bicicletas

#### TAMANHO

Grande: 1.38 x 0.77 m

#### COMPATIBILIDADE

Caminhonetes: Hilux, Ford Ranger, Amarok, L200 Triton, Frontier, S10 e todas as caminhonetes da categoria. (Abertura para acesso à fechadura da caçamba de modo invertido.)

#### EMBALAGEM

1 peça

#### GRANDE

19191



## TRUCKPAD grande/pequeno | Modelo 02

<b>CARACTERÍSTICA</b>	<b>Grande:</b> Transporte de até 5 bicicletas <b>Pequeno:</b> Transporte de até 4 bicicletas
<b>TAMANHO</b>	Grande: 1.35 x 0.77 m Pequeno: 1.20 x 0.70 m
<b>COMPATIBILIDADE</b>	<b>Grande:</b> Caminhonetes compatíveis: Hilux, Ford Ranger, Amarok, L200 Triton, Frontier, S10 e todas as caminhonetes da categoria. <b>Pequeno:</b> Pick-ups menores, Saveiro, Oroch, Toro, Strada, entre outras.
<b>EMBALAGEM</b>	1 peça
<b>GRANDE</b>	19188
<b>PEQUENO</b>	19189



### PROTETOR DE QUADRO TSW

Modelo 01 pt/cz

PESO \_\_\_\_\_ 15 g

MATERIAL \_\_\_\_\_ Neoprene

22685



### PROTETOR DE QUADRO TSW

Modelo 02 pt/cz

PESO \_\_\_\_\_ 15 g

MATERIAL \_\_\_\_\_ Neoprene

22686



### PROTETOR DE QUADRO TSW

Modelo 03 pt/cz

PESO \_\_\_\_\_ 15 g

MATERIAL \_\_\_\_\_ Neoprene

22687





1



2



3



4

1  19479

3  19481

2  19480

4  19482

## BOLSA PARA QUADRO

### Modelo 10

02 compartimentos laterais externos com zíper de alta qualidade | 02 compartimentos externos sem zíper | **Bolsa do celular avulsa:** fixada com velcro com dois zíperes de alta qualidade e com puxadores | Isolamento interno resistente a água | Fixação no Top Tube com auxílio de velcros | Compatível com iPhones 7/ 7PLUS/8/ 8PLUS/ XR/ XS/ XS MAX - LG K11 e celulares com até 6.5"

#### CARACTERÍSTICA

**MATERIAL** PU | Couro sintético

**TAMANHO** Comprimento total 32cm x Largura total 20 cm

**PESO** 246gr

**EMBALAGEM** 30 peças



## BOLSA PARA GUIDÃO Modelo 11

Possui dois zíperes de alta qualidade | Isolamento interno resistente a água | Fixação no suporte de guidão com auxílio de velcros | Quebra sol | Compatível com iPhones 7/ 7PLUS/8/ 8PLUS/ XR/ XS/ XS MAX - LG K11 e celulares com até 6.5"

#### CARACTERÍSTICA

**MATERIAL** PU | Couro sintético

**TAMANHO** Comprimento total 20cm x Largura total 10 cm x Altura 9cm

**PESO** 124gr

**EMBALAGEM** 30 peças

 19483



### BOLSA PARA SELIM Modelo 10



Isolamento interno resistente a água |  
Fixação no canote e no trilho do selim  
com clips de nylon e fita regulável |  
Fechamento principal com clip e  
velcros auxiliares | Bolsinho interno de  
rede PVC

#### CARACTERÍSTICA

MATERIAL PU | Couro sintético | PVC

TAMANHO Aberta: 30cm | Fechada: 25cm |  
Largura: +-9x11cm

PESO 130gr

EMBALAGEM 30 peças

1  19484

2  19485

### BOLSA PARA SELIM Modelo 11



Isolamento interno resistente a água |  
Fixação no canote e no trilho do selim  
com auxílio de velcros | Fechamento  
principal com clip | Zíper de alta  
qualidade com puxador

#### CARACTERÍSTICA

MATERIAL Tecido Oxford

TAMANHO Comprimento 18cm x Largura  
+-8x10cm

PESO 77gr

EMBALAGEM 30 peças

1  19486

2  19487

### BOLSA PARA SELIM Modelo 12



Isolamento interno resistente a água |  
Fixação no canote e no trilho do selim  
com clips de nylon e fita regulável |  
Fechamento principal com zíper de alta  
qualidade | Zíper auxiliar possibilitando  
o aumento da bolsa

#### CARACTERÍSTICA

MATERIAL Tecido Oxford

TAMANHO Comprimento total 15cm x  
Largura +-9x11cm

PESO 77gr

EMBALAGEM 30 peças

 19488



1



2



3



4

### BOLSA PARA SELIM Modelo 13

#### CARACTERÍSTICA

Isolamento interno resistente a água | Fixação no canote e no trilho do selim com auxílio de velcros | Fechamento principal com dois zíperes de alta qualidade com puxadores | Dois bolsos auxiliares laterais externos com o mesmo zíper | Um bolso externo de rede PVC com elástico

#### MATERIAL

PU | Couro sintético

#### TAMANHO

Comprimento 25cm x Largura +-9x11cm

#### PESO

214gr

#### EMBALAGEM

30 peças

1  194893  194912  194904  19492

### PARALAMAS TRASEIRO Nylon Modelo 06

#### CARACTERÍSTICA

Traseiro | Flexível e Resistente

#### FIXAÇÃO

Trilho do selim

#### EMBALAGEM

10 peças

17770



### PARALAMAS DIANTEIRO MTB Nylon Modelo 05

**CARACTERÍSTICA** Dianteiro | MTB | Flexível e Resistente

**FIXAÇÃO** Abraçadeira de nylon

**EMBALAGEM** 10 peças

1  17755

2  17757

3  17756



### PARALAMAS DIANTEIRO MTB Nylon Modelo 06

**CARACTERÍSTICA** Dianteiro | MTB | Flexível e Resistente

**FIXAÇÃO** Abraçadeira de nylon

**EMBALAGEM** 10 peças

1  17758

2  17759

3  17760



**PARALAMAS DIANTEIRO MTB Nylon Modelo 07**

<b>CARACTERÍSTICA</b>	Dianteiro   MTB   Flexível e Resistente
<b>FIXAÇÃO</b>	Abraçadeira de nylon
<b>EMBALAGEM</b>	10 peças

1		17761
2		17762
3		17763



**PARALAMAS DIANTEIRO MTB Nylon Modelo 08**

<b>CARACTERÍSTICA</b>	Dianteiro   MTB   Flexível e Resistente
<b>FIXAÇÃO</b>	Abraçadeira de nylon
<b>EMBALAGEM</b>	10 peças

1		17764
2		17765
3		17766



**PARALAMAS DIANTEIRO MTB Nylon Modelo 09**

<b>CARACTERÍSTICA</b>	Dianteiro   MTB   Flexível e Resistente
<b>FIXAÇÃO</b>	Abraçadeira de nylon
<b>EMBALAGEM</b>	10 peças

1		17767
2		17768
3		17769

## EXPOSITOR CAPACETE NYLON

### CARACTERÍSTICA

- Leve
- Excelente acabamento
- Encaixe para slatwall
- Disponível nas cores preta e laranja

### MATERIAL

Nylon

### PESO

220gr

### EMBALAGEM

10 unidades

 4510

 5037



## EXPOSITOR SAPATILHA E OUTROS

### CARACTERÍSTICA

- Leve
- Excelente acabamento
- Encaixe para slatwall
- Disponível nas cores preta e laranja

### MATERIAL

Acrílico

### PESO

132gr

### EMBALAGEM

10 unidades

 6519

 6520





### CARAMANHOLA TERMICA SPIN MOD. 01

**CARACTERÍSTICA**

- Caramanhola térmica
- Alça de transporte
- Bico removível para limpeza
- Boca larga (facilita limpeza e abastecimento)
- Bpa free
- Tampa inteligente (abre e fecha)

**CAPACIDADE**

680ml

**TAMANHO**

25 x 7.5cm

**EMBALAGEM**

50 unidades

 22617

 22618

 22619

 22620

 22621



### CARAMANHOLA TERMICA SPIN MOD. 02

**CARACTERÍSTICA**

- Caramanhola térmica
- Alça de transporte
- Bico removível para limpeza
- Boca larga (facilita limpeza e abastecimento)
- Bpa free
- Tampa inteligente (abre e fecha)

**CAPACIDADE**

680ml

**TAMANHO**

25 x 7.5cm

**EMBALAGEM**

50 unidades

 22622

 22623

 22624

 22625

 22626



### CARAMANHOLA TERMICA SPIN MOD. 03

#### CARACTERÍSTICA

- Caramanhola térmica
- Alça de transporte
- Bico removível para limpeza
- Boca larga (facilita limpeza e abastecimento)
- Bpa free
- Tampa inteligente (abre e fecha)

#### CAPACIDADE

680ml

#### TAMANHO

25 x 7.5cm

#### EMBALAGEM

50 unidades

 22627

 22628

 22629

 22630

 22631

ACESSÓRIOS E COMPONENTES



### CARAMANHOLA TERMICA SPIN MOD. 04

#### CARACTERÍSTICA

- Caramanhola térmica
- Alça de transporte
- Bico removível para limpeza
- Boca larga (facilita limpeza e abastecimento)
- Bpa free
- Tampa inteligente (abre e fecha)

#### CAPACIDADE

680ml

#### TAMANHO

25 x 7.5cm

#### EMBALAGEM

50 unidades

 22632

 22633

 22634

 22635

 22636

FOTOS MERAMENTE ILUSTRATIVAS. AS INFORMAÇÕES/CONFIGURAÇÕES DE PRODUTOS PODERÃO SOFRER ALTERAÇÕES SEM AVISO PRÉVIO.

ENTRE EM CONTATO COM O SEU CONSULTOR OU FALE COM O NOSSO TIME DE TELEVENDAS PELO (33) 3277-3030.



**CARAMANHOLA FAST NYLON MOD. 01**

**CARACTERÍSTICA**

- Caramanhola não térmica
- Alça de transporte
- Boca larga (facilita limpeza e abastecimento)
- Bpa free

**CAPACIDADE**

650ml

**TAMANHO**

22.5 X 7.5cm

**EMBALAGEM**

50 unidades

 22587

 22589

 22588

 22592

 22593

 22590

 22591





## CARAMANHOLA FAST NYLON MOD. 02

### CARACTERÍSTICA

- Caramanhola não térmica
- Alça de transporte
- Boca larga (facilita limpeza e abastecimento)
- Bpa free

### CAPACIDADE

650ml

### TAMANHO

22.5 X 7.5cm

### EMBALAGEM

50 unidades

 22594

 22596

 22595

 22599

 22600

 22597

 22598



**CARAMANHOLA FAST NYLON MOD. 03**

**CARACTERÍSTICA**

- Caramanhola não térmica
- Alça de transporte
- Boca larga (facilita limpeza e abastecimento)
- Bpa free

**CAPACIDADE**

650ml

**TAMANHO**

22.5 X 7.5cm

**EMBALAGEM**

50 unidades

	22601
	22603
	22602
	22608
	22609
	22604
	22605



### CARAMANHOLA FAST NYLON MOD. 04

**CARACTERÍSTICA**

- Caramanhola não térmica
- Alça de transporte
- Boca larga (facilita limpeza e abastecimento)
- Bpa free

**CAPACIDADE** 650ml

**TAMANHO** 22.5 X 7.5cm

**EMBALAGEM** 50 unidades

-  22610
-  22612
-  22611
-  22615
-  22616
-  22613
-  22614



### CARAMANHOLA TÉRMICA NYLON MOD. 01

**CARACTERÍSTICA**

- Caramanhola térmica
- Nylon
- Boca larga (facilita limpeza e abastecimento)
- Bpa free

**CAPACIDADE**

400ml

**TAMANHO**

19.5 X 7.5cm

**PESO**

105g

**EMBALAGEM**

50 unidades

	22638
	22639
	22640
	22641
	22642
	22643
	22644
	22645

FOTOS MERAMENTE ILUSTRATIVAS. AS INFORMAÇÕES/CONFIGURAÇÕES DE PRODUTOS PODERÃO SOFRER ALTERAÇÕES SEM AVISO PRÉVIO.

ENTRE EM CONTATO COM O SEU CONSULTOR OU FALE COM O NOSSO TIME DE TELEVENDAS PELO (33) 3277-3030.



ACESSÓRIOS E COMPONENTES



## CARAMANHOLA TÉRMICA NYLON MOD. 01

### CARACTERÍSTICA

- Caramanhola térmica
- Nylon
- Boca larga (facilita limpeza e abastecimento)
- Bpa free

### CAPACIDADE

550ml

### TAMANHO

26,5 X 7,5cm

### PESO

135g

### EMBALAGEM

50 unidades

	22646
	22647
	22648
	22649
	22650
	22651
	22652
	22653
	22654

FOTOS MERAMENTE ILUSTRATIVAS. AS INFORMAÇÕES/CONFIGURAÇÕES DE PRODUTOS PODERÃO SOFRER ALTERAÇÕES SEM AVISO PRÉVIO.

ENTRE EM CONTATO COM O SEU CONSULTOR OU FALE COM O NOSSO TIME DE TELEVENDAS PELO (33) 3277-3030.



1



2



3



4



5



6



7



8



## SUPOTE CARAMANHOLA FIBRA VIDRO MOD. 01

### CARACTERÍSTICAS

- Design moderno
- Leve e resistente
- Fixação por 02 parafusos (acompanham o suporte)
- Sistema de fixação com regulagem de posição
- Confeccionado em nylon e fibra de vidro

### OBSERVAÇÕES COMPLEMENTARES

Confeccionado em fibra de vidro, Formato que reduz a possibilidade da caramanhola sair do suporte em terrenos irregulares, Projetado para que a caramanhola tenha um encaixe simples e suave, Construção em 30% fibra de vidro e 70% nylon

### PESO

35gr - peso referente ao suporte com parafusos

### MATERIAL

Nylon / fibra de vidro

### EMBALAGEM

100 unidades

1-		22655	6-		22660
2-		22656	7-		22661
3-		22657	8-		22662
4-		22658			
5-		22659			

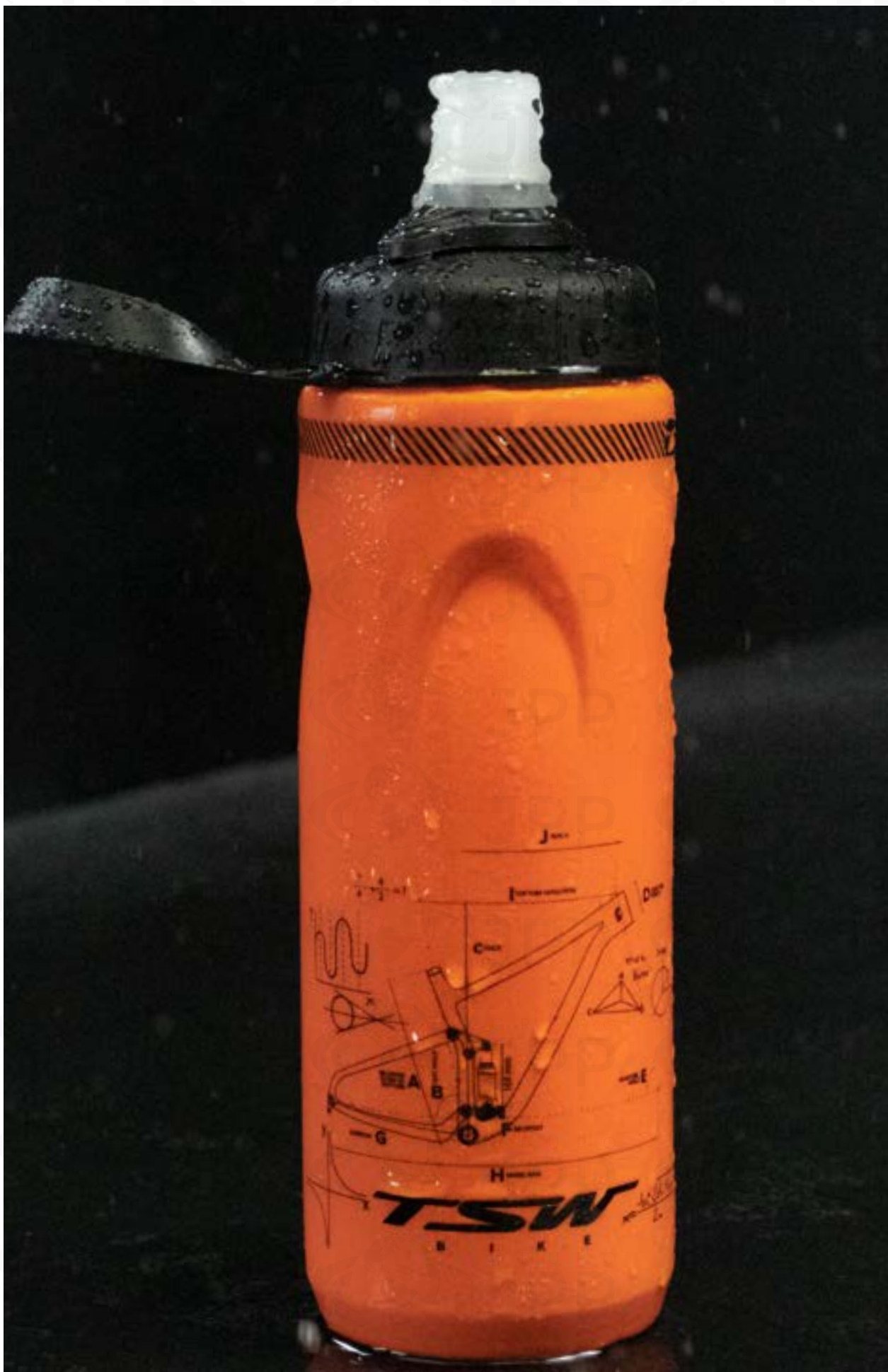

FOTOS MERAMENTE ILUSTRATIVAS. AS INFORMAÇÕES/CONFIGURAÇÕES DE PRODUTOS PODERÃO SOFRER ALTERAÇÕES SEM AVISO PRÉVIO.

ENTRE EM CONTATO COM O SEU CONSULTOR OU FALE COM O NOSSO TIME DE TELEVENDAS PELO (33) 3277-3030.

## REFIL para Mochila de Hidratação

<b>CARACTERÍSTICA</b>	2 litros   Tampa com fechamento em rosca   Tubo de 106 cm
<b>PESO</b>	183g
<b>EMBALAGEM</b>	25 peças

15427



## BOMBA DE AR PÉ alumínio com manômetro digital

<b>CARACTERÍSTICA</b>	Manômetro digital   Válvula padrão alemão   Cabo de madeira   Pilha palito - não inclusa
-----------------------	--

**PSI** 130

**EMBALAGEM** 1 peça

06861



## BOMBA DE AR PÉ alumínio com manômetro

<b>CARACTERÍSTICA</b>	Manômetro   Válvula padrão alemão   Cabo de madeira
-----------------------	---

**PSI** 130

**EMBALAGEM** 1 peça

06860



## BOMBA DE AR alumínio mini manual/pé

<b>CARACTERÍSTICA</b>	Suporte para fixação quadro   Conexão externa com adaptador válvula americana e presta   Apoio para pé
-----------------------	--

**PSI** 110

**MATERIAL** Alumínio

**EMBALAGEM** 10 peças

1  07333

2  07334







## BOMBA DE AR alumínio manual

**CARACTERÍSTICA** Suporte para fixação quadro | Conexão interna com adaptador válvula americana e presta

**PSI** 110

**MATERIAL** Alumínio/nylon

**EMBALAGEM** 10 peças

1  06853

2  06854

3  06855



## BOMBA DE AR alumínio manual

**CARACTERÍSTICA** Suporte para fixação quadro | Conexão interna com adaptador válvula americana e presta

**PSI** 110

**PESO APROXIMADO** 100g

**MATERIAL** Alumínio/Nylon

**EMBALAGEM** 10 peças

1  08632

2  08633

3  08634



## BOMBA DE AR alumínio manual

**CARACTERÍSTICA** Suporte para fixação quadro | Conexão interna com adaptador válvula americana e presta

**PSI** 110

**MATERIAL** Alumínio

**EMBALAGEM** 10 peças

1  04581

2  04582

3  04583



## BOMBA DE AR alumínio manual

**CARACTERÍSTICA** Suporte para fixação quadro | Com adaptador válvula americana e presta

**PSI** 90

**MATERIAL** Alumínio/Nylon

**EMBALAGEM** 10 peças

1  04584



### BOMBA DE AR alumínio manual mini

CARACTERÍSTICA	Suporte para fixação quadro   Válvula presta
PSI	90
MATERIAL	Alumínio
EMBALAGEM	10 peças

1  06851

2  06850

3  06852



### BOMBA DE AR alumínio manual mini

CARACTERÍSTICA	Suporte para fixação quadro   Válvula presta
PSI	90
MATERIAL	Alumínio
EMBALAGEM	10 peças

1  09542

2  09541

3  09543



### BOMBA DE AR Nylon manual

CARACTERÍSTICA	Suporte p/ fixação quadro   Adaptador válvula americana e presta
MATERIAL	Nylon
EMBALAGEM	10 peças

1  05965



### BOMBA DE AR Nylon manual

CARACTERÍSTICA	Adaptador válvula americana e presta
MATERIAL	Nylon
EMBALAGEM	10 peças

1  05971

## CO2 PUMP

**CARACTERÍSTICA** Dispositivo acionador de bomba para cartucho de CO2 (cartucho de CO2 não incluso)

**COMPATIBILIDADE** Válvulas schrader e presta

**MATERIAL** Alumínio

**EMBALAGEM** 10 peças

13364



ACESSÓRIOS E COMPONENTES



## FAROL 180 Lumens

**CARACTERÍSTICA** Bateria recarregável via USB | 4 estágios | 1 LED

**AUTONOMIA** 1:20h (Alto)  
2:40h (Baixo)  
3h (Pisca rápido)  
5h (Pisca lento)

**LÚMENS** 180

**EMBALAGEM** 10 peças



1  06961

2  06962

3  06963

## ADAPTADOR SILICONE para farol

**CARACTERÍSTICA** Compatível com fárois 06.961, 06.962, 06.963 | Com parafuso de fixação

**EMBALAGEM** 200 peças

15237



FOTOS MERAMENTE ILUSTRATIVAS. AS INFORMAÇÕES/CONFIGURAÇÕES DE PRODUTOS PODERÃO SOFRER ALTERAÇÕES SEM AVISO PRÉVIO.

ENTRE EM CONTATO COM O SEU CONSULTOR OU FALE COM O NOSSO TIME DE TELEVENDAS PELO (33) 3277-3030.



## FAROL 400 Lumens

<b>CARACTERÍSTICA</b>	Bateria recarregável via USB Indica nível de carga da bateria Resistente a água 1 LED T6
<b>ESTÁGIOS</b>	5 estágios
<b>AUTONOMIA</b>	8h (25% de brilho) 4h (50% de brilho) 2h (100% de brilho) 4h (Flash lento) 5h (SOS)
<b>LÚMENS</b>	400
<b>BATERIA</b>	18650 Li-ion   2200 mAh, 3,7v
<b>CARREGADOR</b>	Micro USB   3:00 h (1A)
<b>TAMANHO/PESO</b>	85x28x28mm/106g
<b>MATERIAL</b>	Alumínio + Plástico ABS
<b>EMBALAGEM</b>	50 peças

15222





## FAROL 250 Lumens | PARA SUPORTE ARTICULADO

<b>CARACTERÍSTICA</b>	Bateria recarregável via USB   Luz dianteira e traseira   Encaixe para base articulada   Base articulada não inclusa	
<b>ESTÁGIOS</b>	3 estágios para a luz dianteira 3 estágios para a luz traseira	
<b>AUTONOMIA</b>	<b>Dianteira</b> 5h (50% de brilho) 2,5h (100% de brilho) 6h (Flash)	<b>Traseira</b> 25h (100% de brilho) 50h ("respiração") 60h (Flash)
<b>LÚMENS</b>	250	
<b>TEMPO DE RECARGA</b>	3 h	
<b>CARREGADOR</b>	USB	
<b>TAMANHO/PESO</b>	65x32x19mm/52g	
<b>MATERIAL</b>	Alumínio + Plástico	
<b>EMBALAGEM</b>	100 peças	
	15221	



## ADAPTADOR MULTI USO/SUPORTE ARTICULADO

<b>CARACTERÍSTICA</b>	Adaptador para suporte de guidão com suporte para Ciclo computador (Garmim/Bryton) e suporte articulado para Action Cam/Farol
<b>KIT</b>	2 chaves allen - 2 / 4 mm
<b>PESO</b>	69 g
<b>MATERIAL</b>	Alumínio/Nylon
<b>EMBALAGEM</b>	100 peças
	15220



## FAROL COM CARREGADOR USB 500 lumens preto

<b>CARACTERÍSTICA</b>	Estrutura em alumínio   Acompanha cabo usb Indicadores de bateria   Botão on/off na parte superior   Capacidade da bateria 2000mah, 3.7v Dimensões 81 x 45 x 24 mm   Fácil instalação
<b>ESTÁGIOS</b>	Flash 1 – 3hrs / flash 2 – 4hrs / flash 3 – 8 hrs
<b>LÚMENS</b>	500
<b>TEMPO DE RECARGA</b>	3 h
<b>CARREGADOR</b>	USB
<b>PESO</b>	126g
<b>MATERIAL</b>	Alumínio/Plástico
<b>EMBALAGEM</b>	100 peças

24165



## FAROL COM CARREGADOR USB e refletor tras.

<b>CARACTERÍSTICA</b>	Kit farol e refletor   Linha tsw
<b>FAROL</b>	Farol 350 lumens tsw   Estrutura em alumínio Carregamento através do cabo usb   Acompanha cabo usb   Botão on/off na parte superior   Capacidade da bateria 2000mah   Tempo de carga 3-4hrs   Estágios: 100% – 3hrs / 50% – 6hrs   Fecho de luz em 3 posições   Dimensões 105 x 35 x 37 mm   Fácil instalação   Acompanha suporte de fixação
<b>REFLETOR</b>	Refletor traseiro 8 lumens tsw   Estrutura em plástico   Carregamento através do cabo usb Acompanha cabo usb   Botão on/off na parte superior   Capacidade da bateria 200mah Tempo de carga 1hr   4 Modolos de sinalização Fácil instalação   Dimensões 73,5 x 21 x 19,3 mm
<b>PESO</b>	138gr - peso referente ao kit completo
<b>MATERIAL</b>	Alumínio/Plástico
<b>EMBALAGEM</b>	100 peças

23790





## REFLETOR LED

**CARACTERÍSTICA** Para uso dianteiro e traseiro

**TIPO DE LED** 2 leds multi-uso

**EMBALAGEM** 25 peças

1  03384

2  03385



## REFLETOR TRASEIRO 50 Lumens

**CARACTERÍSTICA** Led vermelho | Suporte para fixação no canote prova d'água | 2 modos com 4 níveis de brilho | Cabo USB para recarga

**TIPO DE LED** 44 COB LED'S

**AUTONOMIA**

Modo 1	Modo 2
- 10% (brilho) - 28h	10% (brilho) - 56h
- 25% (brilho) - 14h	25% (brilho) - 28h
- 50% (brilho) - 7h	50% (brilho) - 14h
100% (brilho) - 3.5h	100% (brilho) - 7h

**PESO** 50 g

**TEMPO DE RECARGA** 1-2h

**EMBALAGEM** 120 peças

15219



## REFLETOR TRASEIRO 15 lumens

**CARACTERÍSTICA** Led vermelho | Com 4 modos de iluminação | Suporte para fixação no canote | Cabo USB para recarga

**AUTONOMIA**

4h
10h (Pisca Lento)
12h (Pisca rápido)
8h (Alternado)

**EMBALAGEM** 20 peças

06959



### ADAPTADOR de Silicone

<b>CARACTERÍSTICA</b>	Multi-uso
<b>EMBALAGEM</b>	50 peças
	04557



### ESTOJO DE FERRAMENTAS

<b>CARACTERÍSTICA</b>	Estojo de ferramentas para suporte de caramanhola
<b>MATERIAL</b>	Poliuretano (PU)
<b>MEDIDAS</b>	203x85x74,5mm
<b>EMBALAGEM</b>	1 peça
	10876



### MANOPLA PRETA ANATOMICA E BAR END PRETO

<b>CARACTERÍSTICA</b>	Design moderno   Corpo com acabamento grip	<b>BAR END</b>	(89mm de comprimento)
<b>DIMENSÕES</b>	142 X 30 X 54MM	<b>MATERIAL</b>	TPE (Elastômero Termoplástico)
		<b>PESO</b>	207g
		<b>EMBALAGEM</b>	100 unidades

1 ■■■ 22103





### MANOPLA com anel e trava

CARACTERÍSTICA	Aro preto   Com trava
MATERIAL	TPE
EMBALAGEM	60 peças

06903

06902



### MANOPLA ESPUMA com anel e trava

CARACTERÍSTICA	Aro colorido   Com trava
MATERIAL	Espuma
EMBALAGEM	60 peças

1 06909

2 06910

3 06911



### MANOPLA com anel e trava

CARACTERÍSTICA	Aro colorido   Com 2 travas   Alumínio
----------------	--

1 02910

2 02912

EMBALAGEM 100 peças

FOTOS MERAMENTE ILUSTRATIVAS. AS INFORMAÇÕES/CONFIGURAÇÕES DE PRODUTOS PODERÃO SOFRER ALTERAÇÕES SEM AVISO PRÉVIO.

ENTRE EM CONTATO COM O SEU CONSULTOR OU FALE COM O NOSSO TIME DE TELEVENDAS PELO (33) 3277-3030.



### MANOPLA anatômica 2 trava

**CARACTERÍSTICA** Aro colorido | Com 2 travas | Alumínio

**EMBALAGEM** 50 peças

1  03781

2  03782

3  03977



### MANOPLA com trava

**CARACTERÍSTICA** Aro colorido | Com trava

**MATERIAL** TPE

**EMBALAGEM** 60 peças

1  06895



### MANOPLA MTB

**MATERIAL** pvc.tpr  
**EMBALAGEM** 100 peças

1		06905	3		06908
2		06906	4		07513

MANOPLAS



### MANOPLA SOFT MTB

**MATERIAL** Espuma EVA  
**EMBALAGEM** 100 peças

	07872		07875
	07873		

FOTOS MERAMENTE ILUSTRATIVAS. AS INFORMAÇÕES/CONFIGURAÇÕES DE PRODUTOS PODERÃO SOFRER ALTERAÇÕES SEM AVISO PRÉVIO.

ENTRE EM CONTATO COM O SEU CONSULTOR OU FALE COM O NOSSO TIME DE TELEVENDAS PELO (33) 3277-3030.



### MANOPLA MTB LIGHT silicone

<b>MATERIAL</b>	Confortável   Leve e com uma excelente pegada no guidão   Proporciona uma pilotagem superior nos percursos mais técnicos e longos.
<b>CARACTERÍSTICA</b>	Plugs de fechamento
<b>EMBALAGEM</b>	100 peças

	12597
	12595
	12598
	12596
	10358



### FITA DE GUIDÃO SPEED

<b>CARACTERÍSTICA</b>	Leve, fácil de envolver e ajustar
<b>COMPRIMENTO</b>	195 cm
<b>ESPESSURA</b>	2.5 mm
<b>MODALIDADE</b>	Road bike
<b>ACABAMENTO</b>	Plugs de fechamento
<b>PESO</b>	55g
<b>EMBALAGEM</b>	10 peças

14290



### FITA DE GUIDÃO SPEED SLIM

<b>CARACTERÍSTICA</b>	Macia, fácil de envolver e ajustar
<b>COMPRIMENTO</b>	198 cm
<b>ESPESSURA</b>	3 mm
<b>MODALIDADE</b>	Road bike
<b>ACABAMENTO</b>	Plugs de fechamento
<b>PESO</b>	71g
<b>EMBALAGEM</b>	10 peças
	14289



### FITA DE GUIDÃO SPEED SILICONE GEL

<b>CARACTERÍSTICA</b>	Macia e suave, fácil de envolver e ajustar
<b>COMPRIMENTO</b>	200 cm
<b>MATERIAL</b>	Silicone antiderrapante   Fibra de tecido   EVA 1mm
<b>ESPESSURA</b>	3 mm
<b>MODALIDADE</b>	Road bike
<b>ACABAMENTO</b>	Plugs de fechamento
<b>PESO</b>	74g
<b>EMBALAGEM</b>	10 peças



1		14291
2		14292



### FITA DE GUIDÃO

**CARACTERÍSTICA** Speed | Caixa com par

**MATERIAL** EVA

**EMBALAGEM** 10 peças

1		06912
2		06913
3		06914
4		06915
5		06916

7		06918
8		06919
9		06922



### FITA DE GUIDÃO

**CARACTERÍSTICA** Speed | Caixa com par

**MATERIAL** Microfibras

**EMBALAGEM** 10 peças

1		06921
2		06923
3		06924
4		06925
5		06926

7		06928
8		06929
9		06930



## FITA WRAP para kit de reparo MTB / SPEED

### CARACTERÍSTICA

Universal, funciona com qualquer tipo de bicicleta, independentemente do uso, tamanho ou material | Utilizada para levar espátula, câmara de ar, Co2, bomba e outros acessórios | Obs.: câmara de ar, espátula, Co2 e outras ferramentas não inclusos.

### EMBALAGEM

10 peças

17865

## Selim mtb gel preto mod. 1

### MODELO

- Vazado
- estrutura do assento em polímero, espuma e couro sintético
- Excelente acabamento
- Não acompanha castanha

### MATERIAL

Polímero e aço

### TAMANHO

275 x 160 mm

### PESO

360g

### EMBALAGEM

30 peças

23275



## SELIM MTB PRETO MOD. 2

<b>CARACTERÍSTICA</b>	Selim Tsw <ul style="list-style-type: none"><li>• Vazado</li><li>• Trilho Em Aço</li><li>• Estrutura Do Assento Em Polímero, Espuma E Couro Sintético</li><li>• Excelente Acabamento</li><li>• Largura 160mm</li><li>• Comprimento 275mm</li></ul>
-----------------------	--

<b>PESO</b>	335g
-------------	------

<b>MATERIAL</b>	Espuma/ Couro Sintético
-----------------	-------------------------

<b>TAMANHO</b>	160 x 275 mm
----------------	--------------

<b>EMBALAGEM</b>	30 unidades
------------------	-------------

23276





## ARO 29 X 32F ALUM MTB VAL. PRESTA PT F. T10000 IMP.

### CARACTERÍSTICA

- tsw t10000
- Alumínio 6061
- acabamento anodizado
- largura externa 35mm
- largura interna 30mm
- tubeless ready
- etrto rim size 30-622mm
- 32 furos
- disc brake
- largura do pneu 48mm – 66mm (1.9" – 2.6")
- disponível com válvula presta e válvula americana

### MATERIAL

Alumínio

### PESO

654g (sem ilhós)

### EMBALAGEM

8 Unidades

■ 22833 Presta

■ 22834 Americana

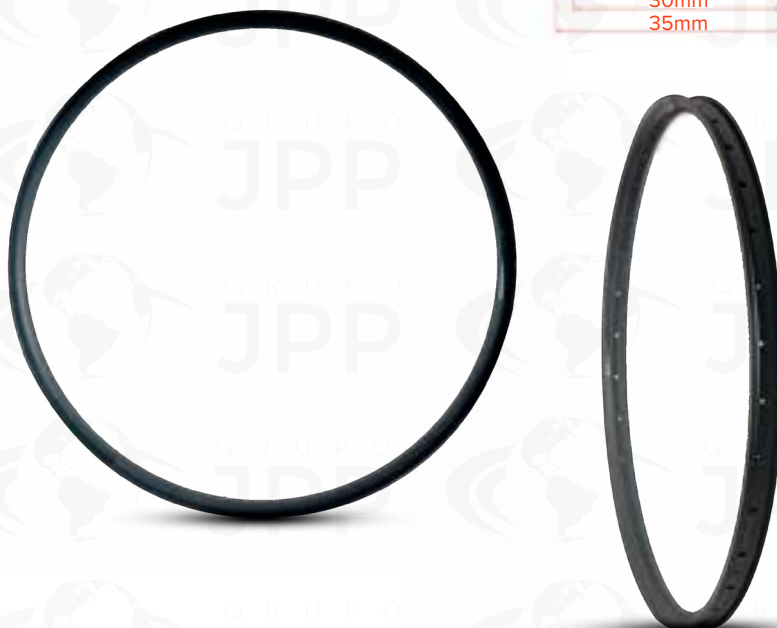

SELIM E COMPONENTES



## PEDIVELA COM EIXO CENTRAL 50 mm

### CARACTERÍSTICA

50mm | Com braço 175mm  
| 3 peças | Com movimento  
central de colar

### EMBALAGEM

10 peças

04477

## PARAFUSO DISC BRAKE ALEN

### CARACTERÍSTICA

Parafuso para fixação  
de disco de freio

### EMBALAGEM

100 peças

05269



FOTOS MERAMENTE ILUSTRATIVAS. AS INFORMAÇÕES/CONFIGURAÇÕES DE PRODUTOS PODERÃO SOFRER ALTERAÇÕES SEM AVISO PRÉVIO.

ENTRE EM CONTATO COM O SEU CONSULTOR OU FALE COM O NOSSO TIME DE TELEVENDAS PELO (33) 3277-3030.



## VALVULA ALLOY TUBELESS

### CARACTERÍSTICA

- Válvula alumínio para tubeless;
- Tampa da válvula removível;
- Tamanhos disponíveis 36mm / 48mm / 60mm / 80mm;

### ORIENTAÇÕES DE INSTALAÇÃO

- Remova a tampa da válvula e a porca de travamento;
- Insira a válvula através do aro;
- Rosqueie o-ring de bloqueio na válvula;
- Aperte à mão a porca de trava;
- Parafuso na tampa da válvula.

### ATENÇÃO

Nossas válvulas tubeless são adequadas universalmente para a maioria das bicicletas de montanha ou road, um kit de conversação é necessário para rodas não tubeless.

### MATERIAL

Alumínio

### PESO APROXIMADO

26gr (peso referente a válvula de 80mm com embalagem).

### EMBALAGEM

50 peças

### 36MM

23688

### 48MM

23689

### 60MM

23690

### 80MM

23691



## NÚCLEO VÁLVULAS TUBELESS

### CARACTERÍSTICA

Núcleo para reparo interno válvula tubeless

### COMPATIBILIDADE

Válvulas tipo Presta

### EMBALAGEM

50 peças

### FATOR

10

14121

## PEDAL CLIP/PLATAFORMA MTB/CASUAL

**CARACTERÍSTICA** Pedal Clip/Plataforma com rolamento DU/Selado e ajuste de tensão

**CATEGORIA** MTB/Casual

**FIXAÇÃO** Face única

**TACO** MTB SPD (Shimano)

**TAMANHO** 103 x 80 x 18 mm

**MATERIAL** Alumínio / Cr-Mo

**PESO** 477g

**EIXO** 9/16

**EMBALAGEM** 1 conjunto

14873



RODAS E COMPONENTES



## PEDAL CLIP SPEED

**CARACTERÍSTICA** Pedal Clip com rolamento DU/Selado e ajuste de tensão

**CATEGORIA** Road

**FIXAÇÃO** Face única

**TACO** Look SPD

**TAMANHO** 71 x 90 x 20 mm

**MATERIAL** Nylon / Cr-Mo

**PESO** 303g

**EIXO** 9/16

**EMBALAGEM** 1 conjunto

14874



FOTOS MERAMENTE ILUSTRATIVAS. AS INFORMAÇÕES/CONFIGURAÇÕES DE PRODUTOS PODERÃO SOFRER ALTERAÇÕES SEM AVISO PRÉVIO.

ENTRE EM CONTATO COM O SEU CONSULTOR OU FALE COM O NOSSO TIME DE TELEVENDAS PELO (33) 3277-3030.

**PEDAL CLIP MTB**

<b>CARACTERÍSTICA</b>	Pedal Clip com rolamento DU/ Selado e ajuste de tensão
<b>CATEGORIA</b>	MTB
<b>FIXAÇÃO</b>	Dupla face
<b>TACO</b>	MTB SPD (Shimano)
<b>TAMANHO</b>	83 x 69 x 20 mm
<b>MATERIAL</b>	Alumínio / Cr-Mo
<b>PESO</b>	348g
<b>EIXO</b>	9/16
<b>EMBALAGEM</b>	1 conjunto

14872

**CONDUÍTE FREIO HIDRÁULICO**

<b>CARACTERÍSTICA</b>	Com conector   1650 mm
<b>EMBALAGEM</b>	20 peças

12336

**PORTA FERRAMENTAS Save Tools**

<b>CARACTERÍSTICA</b>	Ideal para transportar Camara de ar, ferramentas, chaves e suplementos   Acabamento interno tipo EVA que elimina ruídos
<b>MATERIAL</b>	Plástico
<b>COMPATIBILIDADE</b>	Pode ser transportado no suporte de caramanholas
<b>TAMANHO</b>	ø 7,5 cm   Altura: 13,5 cm
<b>EMBALAGEM</b>	1 peça

14703



14704



## ESPÁTULA NYLON

**CARACTERÍSTICA** Para retirar câmara |  
Formato ergonômico cabe  
confortavelmente na mão |  
2 peças

**EMBALAGEM** 10 peças

1		10875
2		10874
3		10873



## CONJUNTO ACESSÓRIOS QUADRO EVO



**CARACTERÍSTICA**

- Conjunto acessórios quadro tsw evo
- Guia dos condutites superiores
- Guia dos condutites inferiores
- Suporte do guia de corrente em alumínio
- Guia do cabo de aço interno
- Acompanha parafusos de fixação

**MATERIAL**

Alumínio e nylon

**EMBALAGEM**

10 peças

**PESO**

46g

**FATOR**

1

**COMPATÍVEL**

TSW modelo Evo Quest 22/23

24161



## CONJUNTO ACESSORIOS QUADRO E-BIKE

<b>CARACTERÍSTICA</b>	<ul style="list-style-type: none"> <li>• Conjunto acessórios quadro tsw full e-quest</li> <li>• Guia dos conduites superiores</li> <li>• Guia dos conduites inferiores</li> <li>• Kit de parafusos da balança</li> </ul>
<b>MATERIAL</b>	Alumínio
<b>OBSERVAÇÃO</b>	Não acompanha rolamentos da balança
<b>EMBALAGEM</b>	10 peças
<b>PESO</b>	240g
<b>FATOR</b>	1
<b>COMPATÍVEL</b>	TSW modelo E-Quest 22/23

24158



## CONJUNTO ACESSORIOS QUADRO FULL XC

<b>CARACTERÍSTICA</b>	<ul style="list-style-type: none"> <li>• Conjunto acessórios quadro tsw full xc</li> <li>• Guia dos conduites superiores</li> <li>• Guia dos conduites inferiores</li> <li>• Kit de parafusos da balança</li> </ul>
<b>MATERIAL</b>	Alumínio e nylon
<b>OBSERVAÇÃO</b>	Não acompanha rolamentos da balança
<b>EMBALAGEM</b>	10 peças
<b>PESO</b>	160g
<b>FATOR</b>	1
<b>COMPATÍVEL</b>	TSW Full Quest modelo 22/23

24159



## CONJUNTO ACESSORIOS QUADRO ENDURO

<b>CARACTERÍSTICA</b>	<ul style="list-style-type: none"> <li>• Conjunto acessórios quadro tsw full all quest</li> <li>• Guia dos conduites superiores</li> <li>• Guia dos conduites inferiores</li> <li>• Kit de parafusos da balança</li> <li>• Suporte adaptador traseiro post mount para disco 180mm</li> </ul>
<b>MATERIAL</b>	Alumínio e nylon
<b>OBSERVAÇÃO</b>	Não acompanha rolamentos da balança
<b>EMBALAGEM</b>	10 peças
<b>PESO</b>	274g
<b>FATOR</b>	1
<b>COMPATÍVEL</b>	TSW All Quest 2022

24160

## CONJUNTO ACESSORIOS QUADRO EVO/2024



### CARACTERÍSTICA

- Conjunto acessórios quadro Evo Quest
- Linha 2024
- Eixo traseiro boost M12 x 175L x P1.0 (01 Un)
- Abraçadeira alumínio 31.6MM com parafuso (01 un)
- Conjunto de parafusos do suporte de caramanhola (04 un)
- Tampa cega da passagem do cabo de marcha no chainstay (02 un)
- Terminal guia da passagem do cabo de marcha no chainstay (01 un)
- Acabamento emborrachado da passagem da magueira de freio (03 un) “

### MATERIAL

borracha/plástico/alumínio

### EMBALAGEM

10 unidades

### PESO

90gr

### FATOR

01 unidades

25924

## CONJUNTO ACESSORIOS QUADRO FULL 2024



### CARACTERÍSTICA

- Conjunto Acessórios Quadro Full Quest
- Linha 2024
- Eixo Traseiro Boost M12 X 175L X P1.0 (01 Un)
- Abraçadeira Alumínio 31.6mm Com Parafuso (01 Un)
- Parafuso M12 Da Balança Traseira (01 Un)
- Conjunto De Parafusos Cônicos M10 De Conexão Do Link Com Seat Stay (02 Un)
- Conjunto De Parafusos M10 De Conexão Do Link Do Seat Tube (02 Un)
- Conjunto De Arruelas Calço (02 N°2, 02 N°3, 04 Lisas)
- Conjunto De Parafusos Do Suporte De Caramanhola (04 Un) • Parafuso M10 De Fixação Do Shock No Top Tube (01 Un)
- Tampa Cega Da Passagem Do Cabo De Marcha No Chainstay (02 Un)
- Terminal Guia Da Passagem Do Cabo De Marcha No Chainstay (01 Un)
- Acabamento Emborrachado Da Passagem Da Magueira De Freio (03 Un)

### MATERIAL

alumínio/plástico/borracha

### EMBALAGEM

05 unidades

### PESO

100gr

### FATOR

01 unidades

25925





### GANCHEIRA PADRÃO UDH TRAS. PARA QUADRO ALUM/CARBON MOD. 29

Gancheira udh | linha tsw  
Padrão udh (tipo sram)  
Alumínio  
Acabamento preto  
Medida do eixo 12mm  
Passo da rosca 1.0mm  
Comprimento da rosca 12mm

#### CARACTERÍSTICA

#### EMBALAGEM

#### PESO

#### FATOR

20 peças

34g

1

24143



### GANCHEIRA TRAS. PARA QUADRO CARBON MOD. 26

Gancheira do quadro para fixação do câmbio  
• Alumínio  
• Acabamento preto  
• Medida do eixo 12mm  
• Passo da rosca 1.5mm  
• Comprimento da rosca 12mm

#### CARACTERÍSTICA

#### OBSERVAÇÃO

#### EMBALAGEM

#### PESO

#### FATOR

Compatível com o quadro da bicicleta full quest advanced+ e similares.

20 peças

20g

1

22974



### GANCHEIRA TRAS. PARA QUADRO CARBON MOD. 28

Gancheira do quadro para fixação do câmbio  
• Alumínio  
• Acabamento preto  
• Medida do eixo 12mm  
• Passo da rosca 1.5mm  
• Comprimento da rosca 12mm

#### CARACTERÍSTICA

#### OBSERVAÇÃO

#### EMBALAGEM

#### PESO

#### FATOR

Compatível com o quadro da bicicleta tsw e-quest

20 peças

25g

1

24144



## GANCHEIRA Modelo 01/14

### CARACTERÍSTICA

Traseira | Para quadro de alumínio | Usada no **VICINI, KONA, SOLL, ASTRO, SPEED**

### EMBALAGEM

5 peças

### FATOR

5

01393



## GANCHEIRA Modelo 02/07

### CARACTERÍSTICA

Traseira | Para quadro de alumínio | Usada no **New Hunter, Storm 2012, GIANT**

### EMBALAGEM

5 peças

### FATOR

5

02919



## GANCHEIRA Modelo 03

### CARACTERÍSTICA

Traseira | Para quadro de alumínio | Usada no **Warship Freeride, KONA, KHS**

### EMBALAGEM

5 peças

### FATOR

5

02921



## GANCHEIRA Modelo 04

### CARACTERÍSTICA

Traseira | Para quadro de alumínio | Usada no **Carbono PRO RACE**

### EMBALAGEM

5 peças

### FATOR

5

02922



## GANCHEIRA Modelo 05

### CARACTERÍSTICA

Traseira | Para quadro de alumínio | Usada no **Storm 2013, AT 5.0, Elite e Hunter**

### EMBALAGEM

5 peças

### FATOR

5

03293



## GANCHEIRA Modelo 06

### CARACTERÍSTICA

Traseira | Para quadro de alumínio | Usada no **Ride, Ride 2021/2022, Posh e Warship 2014, Vulcano Pressure, Pressure 2021, Way, Way 26" 2021/2022 Nina, Bolt 2021/2022**

### EMBALAGEM

5 peças

### FATOR

5

03753



## GANCHEIRA Modelo 08

### CARACTERÍSTICA

Traseira | Para quadro de alumínio | Usada no **Jump**

### EMBALAGEM

5 peças

### FATOR

5

03751



## GANCHEIRA Modelo 09

### CARACTERÍSTICA

Traseira | Para quadro de alumínio | Usada no **Carbono FLY 27.5**

### EMBALAGEM

5 peças

### FATOR

5

03749



## GANCHEIRA

### Modelo 10

**CARACTERÍSTICA** Traseira | Para quadro de alumínio | Usada no **Pro Elite e Pro Elite New**

**EMBALAGEM** 5 peças

**FATOR** 5

03750



## GANCHEIRA

### Modelo 11

**CARACTERÍSTICA** Traseira | Para o quadro de alumínio | Usada no **Carbono FLY 29**

**EMBALAGEM** 5 peças

**FATOR** 5

04555

## GANCHEIRA

### Modelo 12

**CARACTERÍSTICA** Traseira | Para quadro de alumínio | Usada no **AWE, Storm e Jump 2021/2022**

**EMBALAGEM** 5 peças

**FATOR** 5

06441



## GANCHEIRA

### Modelo 15

**CARACTERÍSTICA** Traseira | Usada na **Bike Jump**

**EMBALAGEM** 5 peças

**FATOR** 5

09676

## GANCHEIRA

### Modelo 17

**CARACTERÍSTICA** Traseira | Para quadro de alumínio | **Agang, Apollo (Australia), Atlanta, Bergamont, BMC Crescent, Carrera, Centurion, DBS, Definitive Haro bikes, Hercules, Intec KHS, kildemoes, Merida, Novara, Orange, Q Bike Shogun, Staiger, Sinus, Vario, Voodoo, VSF Fahrradmanufaktur Wheeler, Winora**

**EMBALAGEM** 5 peças

**FATOR** 5

12062



## GANCHEIRA

### Modelo 16

**CARACTERÍSTICA** Traseira | Para quadro de alumínio | **Air Borne, Avanti, Breezer, Bergamont, Coluver, Corratec, Cinelli, Centurion Cube, Da Bomb, Go Sport GT, Hasa, Intec, Kalkhoff KHS, KTM, Marin, Massi Mongoose, Nakamura Nirve, Nishiki, Orbea, Q Bike Raleigh, Saracen, Schwinn Scrapper, Univega, Vario Venzo, Viper, Wheeler**

**EMBALAGEM** 5 peças

**FATOR** 5

12061

## GANCHEIRA Modelo 18

### CARACTERÍSTICA

Traseira | Para quadro de alumínio | TSW Ride Plus 2021/2022 , TSW Hunch / Hunch Plus 2021/2022, TSW Stamina 2019/2020, Stamina 2021/2022, TSW Hurry 2019/2020, TSW Hurry 2021/2022, Apollo (Australia), Atlanta, Author (bicyclers), Avanti, Bergamont, Bianch, Blue (Bicycles), BMC, BH Boardman, Bulls, Carver Claud butler, Commencal Corratec, Crescent, Cresta DBS, Definitive, Diamant, Dynamics, Felt, Flanders FRW, Fiji, Fusion, Gary Fisher Ghost, Giant, GT, Haibike, Haro bikes, Hawk, Hercules, Ideal bikes Intec, Iron horse, Jamis, Jeep, K2 Kalkhoff, Kellys, KHS, Kinesis(frame), Kona, Lombardo Marin, Massi, Maxx, MBK, Merida Mongoose, Morewood, Morrison, Motobecane, Muddy Fox, useuw Musing, Nakamura, Novara, NS-Bikes, Orange, Peugeot, Planet X Q Bike, Raleigh, Redline, Schwinn Scrapper, Sensa, Staiger, Stevens Stork, Sunn, Sinus, Trek, Trenga DE, Univega, Vario, Ventana, Venzo, Villiger, Viper, Vitus, Voodoo, Wheeler, Wilier, Winora, X-Cross

### EMBALAGEM

5 peças

### FATOR

5

12063



## GANCHEIRA Modelo 19

### CARACTERÍSTICA

Traseira | Para quadro de alumínio | CMP, Commencal Cyclewolf, Da Bomb Falcon, Felt, Haibike Hercules, Vario, Winora

### EMBALAGEM

5 peças

### FATOR

5

12064

## GANCHEIRA Modelo 20

### CARACTERÍSTICA

Traseira | Para quadro de alumínio | Cube, Hercules Sinus, Winora

### EMB

5 peças

### FATOR

5

12065



## GANCHEIRA Modelo 21

### CARACTERÍSTICA

Traseira | Para quadro de alumínio | Scott

### EMBALAGEM

5 peças

### FATOR

5

12066



## GANCHEIRA Modelo 22

### CARACTERÍSTICA

Traseira | Para quadro de alumínio | TSW Jump 2019/2020 Lapierre

### EMBALAGEM

5 peças

### FATOR

5

12067

## GANCHEIRA Modelo 23

### CARACTERÍSTICA

Traseira | 2 parafusos | Eixo passante | Eixo de 12 mm | Compatível com o TSW Yukon 2021

### EMBALAGEM

5 peças

### FATOR

5

14294



C A T Á L O G O

**RAVA**

C O M P O N E N T E S







XT M91

RAVA

29

# Nina Teen



16"  
WHEELS

	<b>QUADRO</b>	Rava Nina Teen 16"   Aço   <b>Paralamas:</b> Nylon sem haste   <b>Porta corrente:</b> Nylon inteiriço (cobre toda a parte externa da transmissão)   <b>Rodinhas:</b> Aço reforçada e emborrachada   <b>Acessórios de proteção:</b> no suporte e na barra de guidão
	<b>GARFO</b>	Rava   Aço   Aro 16"
	<b>SUSPENSÃO TRASEIRA</b>	N/A
	<b>MOVIMENTO DE DIREÇÃO</b>	Standard   Rosca   Esferada
	<b>GUIDÃO</b>	Cross   25.4 mm   Aço
	<b>SUORTE DE GUIDÃO</b>	Chanfrado   Aço
	<b>MANOPLA</b>	Nylon
	<b>CONJUNTO DE FREIO</b>	V-Brake   Aço   <b>Manete:</b> MTB de nylon com reguladores   Alumínio
	<b>DISCO DE FREIO</b>	N/A
	<b>ARO/RAIO</b>	<b>Aro:</b> 16"   Alumínio   Preto   Folha simples   20 furos <b>Raio:</b> Zincado

	<b>CUBOS</b>	Aço   Eixo 9 mm   Porca sextavada   20 F
	<b>PNEU / CÂMARA DE AR</b>	Aro 16" x 2.125   Importado <b>Câmara:</b> Aro 16"   Válvula americana
	<b>PEDIVELA</b>	Monobloco   115 mm   Preto
	<b>CORRENTE</b>	Comum   Importada
	<b>MOVIMENTO CENTRAL</b>	Esferado   50mm
	<b>RODA LIVRE</b>	16 Dentes   Coroa 32 D   Aço
	<b>CÂMBIO DIANTEIRO</b>	N/A
	<b>CÂMBIO TRASEIRO</b>	N/A
	<b>ALAVANCA</b>	N/A
	<b>SELIM</b>	Infantil com suporte de apoio
	<b>CANOTE</b>	Aço   25.4 mm
	<b>ABRACADEIRA</b>	N/A
	<b>PEDAL</b>	Infantil   Nylon sueco 1/2   Preto

16" | IMPORTADA

ÚNICO ■ 17404

ÚNICO ■ 17405

RAVA

FOTOS MERAMENTE ILUSTRATIVAS. AS INFORMAÇÕES/CONFIGURAÇÕES DE PRODUTOS PODERÃO SOFRER ALTERAÇÕES SEM AVISO PRÉVIO.

ENTRE EM CONTATO COM O SEU CONSULTOR OU FALE COM O NOSSO TIME DE TELEVENDAS PELO (33) 3277-3030.

# Nina Teen



20"  
WHEELS

RAVA

	<b>QUADRO</b>	Rava Nina Teen   Paralamas: Nylon   Cesta: Arame preto   Porta corrente: Nylon inteiriço ( cobre toda a parte externa da transmissão   Rodinhas: Aço reforçada e emborrachada
	<b>GARFO</b>	Aço   Aro 20" Rosca   Suporte para freio v-brake
	<b>SUSPENSÃO TRASEIRA</b>	N/A
	<b>MOVIMENTO DE DIREÇÃO</b>	Standard   Esferada
	<b>GUIDÃO</b>	Curvado   Aço   Preto   25.4mm/550mm
	<b>SUPORTE DE GUIDÃO</b>	Chanfrado   Alumínio
	<b>MANOPLA</b>	Nylon
	<b>CONJUNTO DE FREIO</b>	V-Brake   Aço   Manete: Nylon com reguladores
	<b>DISCO DE FREIO</b>	N/A
	<b>ARO/RAIO</b>	Aro: 20"   Alumínio preto   Folha simples   28 furos   Raio: Aço preto   2mmx190mm

	<b>CUBOS</b>	Aço preto   28 furos   Eixo maciço com porca
	<b>PNEU / CÂMARA DE AR</b>	Aro 20"   20x2.125   Importado
	<b>PEDIVELA</b>	Monobloco   140mm   Aço   Preto
	<b>CORRENTE</b>	Bronze Maya   Importada
	<b>MOVIMENTO CENTRAL</b>	Esferado   50mm
	<b>RODA LIVRE</b>	Bronze   16 Dentes   Importado
	<b>CÂMBIO DIANTEIRO</b>	N/A
	<b>CÂMBIO TRASEIRO</b>	N/A
	<b>ALAVANCA</b>	N/A
	<b>SELIM</b>	Infantil com suporte de apoio   Castanha
	<b>CANOTE</b>	Aço preto   25.4mmx250mm
	<b>ABRACADEIRA</b>	N/A
	<b>PEDAL</b>	Nylon sueco 1/2

20" | IMPORTADA

ÚNICO  17408

ÚNICO  17409

FOTOS MERAMENTE ILUSTRATIVAS. AS INFORMAÇÕES/CONFIGURAÇÕES DE PRODUTOS PODERÃO SOFRER ALTERAÇÕES SEM AVISO PRÉVIO.

ENTRE EM CONTATO COM O SEU CONSULTOR OU FALE COM O NOSSO TIME DE TELEVENDAS PELO (33) 3277-3030.



# pressure jr



20"  
WHEELS

Aço

Mega  
Over

07  
velocidades

Disco  
Mecânico

13.08

 <b>QUADRO</b>	Aro 20"   Rava Pressure Jr   Aço   Direção Mega Over   M. Central BSA   Freio: Disco Standard (IS)   Suporte para descanso   Descanso Lateral	 <b>PEDIVELA</b>	Engrenagem Single   40 dentes   Braço 160 mm   Aço
 <b>GARFO</b>	Garfo suspensão Rava   Aro 20"   Freio: Disco Standard (IS)   Aço   Espiga Over headset	 <b>CORRENTE</b>	Tec   7 Velocidades
 <b>SUSPENSÃO TRASEIRA</b>	N/A	 <b>EIXO CENTRAL</b>	Rosca   34.7 x 113 mm   Ponta quadrada
 <b>MOVIMENTO DE DIREÇÃO</b>	Mega Over   Semi-integrado   Esfera	 <b>RODA LIVRE</b>	Roda Livre 7V.   14/28D.   Index
 <b>GUIDÃO</b>	Rise bar   Aço   31.8 x 620 mm	 <b>CÂMBIO DIANTEIRO</b>	N/A
 <b>SUPORTE DE GUIDÃO</b>	Alumínio   31.8 mm   90 mm	 <b>CÂMBIO TRASEIRO</b>	Shimano   7 Velocidades   Index   RD-TZ31A
 <b>MANOPLA</b>	MTB   Borracha	 <b>ALAVANCA</b>	Shimano   Revoshift   7 velocidades
 <b>CONJUNTO DE FREIO</b>	Freio a disco mecânico   Dianteiro/Traseiro	 <b>SELIM</b>	Rava   Com castanha   Trilho de aço
 <b>DISCO DE FREIO</b>	160 mm   Aço   Parafuso	 <b>CANOTE</b>	Para castanha   27.2 x 250 mm   Aço
 <b>ARO/RAIO</b>	Aro: Rava 20"   Parede dupla   Freio a disco   Alumínio   Raio (Aço) Preto com niple	 <b>ABRAÇADEIRA</b>	Abraçadeira 31.8mm   Blocação
 <b>CUBOS</b>	<b>Dianteiro:</b> Aço   36 furos   Freio a disco (Parafuso) - <b>Traseiro:</b> Aço   36 furos   Rosca (Roda livre)   Freio a disco (Parafuso)	 <b>PEDAL</b>	Plataforma   Preto   Nylon
 <b>PNEU / CÂMARA DE AR</b>	<b>Pneu:</b> Pneu 20 x 2.1" <b>Câmara:</b> 20"   Válvula americana	<b>20" IMPORTADA</b>	
		ÚNICO	 17412
		ÚNICO	 17413
		ÚNICO	 17414

FOTOS MERAMENTE ILUSTRATIVAS. AS INFORMAÇÕES/CONFIGURAÇÕES DE PRODUTOS PODERÃO SOFRER ALTERAÇÕES SEM AVISO PRÉVIO.

ENTRE EM CONTATO COM O SEU CONSULTOR OU FALE COM O NOSSO TIME DE TELEVENDAS PELO (33) 3277-3030.

**RAVA**

# Sunny | PRO



RAVA

	<b>QUADRO</b>	Rava Sunny-pro   Balance   Aro 12"   Aço   Apoio de nylon para os pés
	<b>GARFO</b>	Rava   Rígido   Aro 12"   Aço
	<b>CAIXA DE DIREÇÃO</b>	Sueca   Com rosca   Esferada
	<b>GUIDÃO</b>	Aço   Rise bar   25.4 x 420 mm
	<b>SUPORTE DE GUIDÃO</b>	Aço   Tipo sueco
	<b>MANOPLA</b>	Borracha
	<b>CONJUNTO DE FREIO</b>	Tambor   Maçaneta de Nylon
	<b>ARO/RAIO</b>	Aro: Aço   12" / Raio: Preto   2.0 mm
	<b>CUBOS</b>	Aço com esfera   Eixo de 9 mm
	<b>PNEU / CÂMARA DE AR</b>	Pneu com cravo   12 x 2.25" / Câmara com válvula americana
	<b>CANOTE</b>	Aço   25.4 mm   Selim integrado
	<b>ABRAÇADEIRA</b>	Alumínio   Parafuso

IMPORTADA

12" 17402

12" 17403

FOTOS MERAMENTE ILUSTRATIVAS. AS INFORMAÇÕES/CONFIGURAÇÕES DE PRODUTOS PODERÃO SOFRER ALTERAÇÕES SEM AVISO PRÉVIO.

ENTRE EM CONTATO COM O SEU CONSULTOR OU FALE COM O NOSSO TIME DE TELEVENDAS PELO (33) 3277-3030.

# Sunny



RAVA

	<b>QUADRO</b>	Rava Sunny   Balance   Aro 12"   Aço
	<b>GARFO</b>	Rava   Rígido   Aro 12"   Aço
	<b>CAIXA DE DIREÇÃO</b>	Bucha
	<b>GUIDÃO</b>	Aço   Reto   Integrado
	<b>MANOPLA</b>	Borracha
	<b>RODA</b>	Aro 12"   Nylon   Pneu EVA semi-rígido
	<b>CANOTE</b>	Aço   25.4 mm   Selim integrado

## IMPORTADA

12"  17497

12"  17498

12"  17499

12"  17500

FOTOS MERAMENTE ILUSTRATIVAS. AS INFORMAÇÕES/CONFIGURAÇÕES DE PRODUTOS PODERÃO SOFRER ALTERAÇÕES SEM AVISO PRÉVIO.

ENTRE EM CONTATO COM O SEU CONSULTOR OU FALE COM O NOSSO TIME DE TELEVENDAS PELO (33) 3277-3030.



FOTOS MERAMENTE ILUSTRATIVAS. AS INFORMAÇÕES/CONFIGURAÇÕES DE PRODUTOS PODERÃO SOFRER ALTERAÇÕES SEM AVISO PRÉVIO.

ENTRE EM CONTATO COM O SEU CONSULTOR OU FALE COM O NOSSO TIME DE TELEVENDAS PELO **(33) 3277-3030**.



## QUADRO 29" RAVA RAGE CARBON

<b>MODELO</b>	29"   Rava RAGE CARBON   Boost 148mm Cabeamento interno   Suporte para câmbio dianteiro/ guia de corrente direct mount
<b>DIREÇÃO</b>	Integrada (42MM X 52MM)
<b>CANOTE</b>	Diâmetro do tubo 31.6 mm   Acompanha abraçadeira do tubo do canote
<b>FREIO</b>	Suporte de freio traseiro post mount dentro do chainstay
<b>MOVIMENTO CENTRAL</b>	Press Fit   41 x 92 mm

<b>EIXO</b>	Acompanha eixo traseiro Boost
<b>PNEU</b>	Largura máxima 29" x 2.35
<b>MATERIAL</b>	Carbono
<b>PESO MÁXIMO SUPORTADO</b>	100kg
<b>PESO</b>	1.357g (Peso referente ao quadro 17" com abraçadeira, gancheira e eixo traseiro)
<b>EMBALAGEM</b>	1 unidade

<b>CINZA/VERMELHO</b>	
15.5	22113

17	-
----	---

19	-
----	---

<b>CINZA</b>	
--------------	--

15.5	-
------	---

17	-
----	---

19	-
----	---

**RAVA**

## Gancheira traseira para quadro Carbon mod. Rage



<b>CARACTERÍSTICA</b>	Pintura anodizada Design moderno Cor preta Fixação do eixo traseiro m12 x 1.5mm Acompanha parafuso para fixação
<b>MATERIAL</b>	Alumínio
<b>PESO</b>	13 gr (Gancheira e parafuso)
<b>EMBALAGEM</b>	5 unidades

22121

FOTOS MERAMENTE ILUSTRATIVAS. AS INFORMAÇÕES/CONFIGURAÇÕES DE PRODUTOS PODERÃO SOFRER ALTERAÇÕES SEM AVISO PRÉVIO.

ENTRE EM CONTATO COM O SEU CONSULTOR OU FALE COM O NOSSO TIME DE TELEVENDAS PELO (33) 3277-3030.



## QUADRO 29" MTB NAZCA

<b>MODELO</b>	29"   Quadro Rava MTB   Boost 148mm x 12mm   Cabeamento interno   Dois suportes de caramanhola
<b>DIREÇÃO</b>	Tapared semi-integrada (44 x 55mm)
<b>CANOTE</b>	Diâmetro 31.6mm Passagem de cabo para canote retrátil
<b>FREIO</b>	Suporte de freio traseiro Post Mount dentro do Chainstay
<b>MOVIMENTO CENTRAL</b>	BSA 34.7 x 73mm
<b>EIXO</b>	Eixo traseiro m12 x 1.5mm – 170mm
<b>PNEU</b>	Diâmetro máximo 2.40 (60-622) cravos baixos
<b>MATERIAL</b>	Alumínio 6061
<b>PESO</b>	1.970g (Peso referente ao quadro "M" incluindo eixo e acessórios)
<b>EMBALAGEM</b>	2 unidades

AZUL/CINZA	
15.5	24130
17	24134
19	24138

CINZA/VERMELHO F	
15.5	24132
17	24136
19	24140





CINZA	
15.5	24131
17	24135
19	24139
21	24142

VERMELHO/CINZA	
15.5	24129
17	24133
19	24137
21	24141





### MEIA CICLISMO RIDE MOD.06 SUAVE COMPRESSÃO

<b>CARACTERÍSTICA</b>	Tamanho único
<b>TAMANHO</b>	39-43
<b>MODALIDADE</b>	Speed e MTB
<b>COMPRESSÃO</b>	Suave
<b>MATERIAL</b>	Poliéster
<b>PESO</b>	60g
<b>EMBALAGEM</b>	10 peças

- 01  23682
- 02  23683
- 03  23684
- 04  23685

### MEIA CICLISMO RIDE MOD.07 SUAVE COMPRESSÃO

<b>CARACTERÍSTICA</b>	Tamanho único
<b>TAMANHO</b>	39-43
<b>MODALIDADE</b>	Speed e MTB
<b>COMPRESSÃO</b>	Suave
<b>MATERIAL</b>	Poliéster
<b>PESO</b>	60g
<b>EMBALAGEM</b>	10 peças

- 01  23686
- 02  23687



**RAVA**



## SUPORTE CARAMANHOLA FIBRA VIDRO MOD. 01 PRETO

### CARACTERÍSTICAS

Design moderno  
Leve e resistente  
Fixação por 02 parafusos (acompanham o suporte)  
Sistema de fixação com regulagem de posição  
Confeccionado em nylon e fibra de vidro

### MATERIAL

Nylon / fibra de vidro

### OBSERVAÇÃO



Confeccionado em fibra de vidro, Formato que reduz a possibilidade da caramanhola sair do suporte em terrenos irregulares, Projetado para que a caramanhola tenha um encaixe simples e suave, Construção em 30% fibra de vidro e 70% nylon

### PESO

35gr - peso referente ao suporte com parafusos

### EMBALAGEM

100 peças

1		22663
2		22664
3		22665





## CAPACETE RAKAN TAM. 56-61

### ABERTURAS DE CIRCULAÇÃO DE AR

14

### CONSTRUÇÃO/ESTRUTURA

In mold | Design aerodinâmico | Estrutura robusta

### SISTEMA DE FECHAMENTO

Fivela

### SISTEMA REGULÁVEL

Fivela e Dial giratório para melhor encaixe na cabeça

### ENCHIMENTO

Espuma | Removível e lavável

### SINALIZAÇÃO

Com LED vermelho 3 níveis de alerta

### PESO

237g

1  24911

2  24912

3  24913

**>> INFORMAÇÕES DOS ACESSÓRIOS**  
Possui encaixe para GoPro

RAVA



**| CAPACETE SPACE IV**

**ABERTURAS DE CIRCULAÇÃO DE AR**

18

**CONSTRUÇÃO/ESTRUTURA**

In mold | PC + EPS | Design aerodinâmico | Estrutura robusta

**SISTEMA DE FECHAMENTO**

Fivela

**SISTEMA REGULÁVEL**

Fivela e dial giratório para melhor encaixe na cabeça

**ENCHIMENTO**

Espuma removível e lavável

**PESO**

193g

L/M  24914/24915

L/M  24916/24917

L/M  24918/24919

L/M  24920/24921



**INFORMAÇÕES DOS ACESSÓRIOS**

Acompanha viseira

## Kit capacete little child play + acessórios

ABERTURAS DE CIRCULAÇÃO DE AR	11
CONSTRUÇÃO	Pvc + Eps
SISTEMA DE FECHAMENTO	Fivela
SISTEMA REGULÁVEL	Sim
CONSTRU SISTEMA DE REGULAGEM	Ajustável na fivela
ESPUMA LAVÁVEL	Sim
WISEIRA	Não possui
FAIXA REFLETIVA	Não possui
CODIGO:	25018 - VM 25019 - PT



### >> INFORMAÇÕES DOS ACESSÓRIOS

Joelheiras - 1 par  
Cotoveleiras - 1par

## Capacete little child fan c/ acessórios

ABERTURAS DE CIRCULAÇÃO DE AR	6
CONSTRUÇÃO	Pvc + Eps
SISTEMA DE FECHAMENTO	Fivela
SISTEMA REGULÁVEL	Sim
CONSTRU SISTEMA DE REGULAGEM	Ajustável na fivela
WISEIRA	Não possui
FAIXA REFLETIVA	Não possui
CODIGO:	25025 - AZ 25029 - LJ 25027 - FLOWERS 25026 - BALL CORES 25028 - MELÂNCIA



### >> INFORMAÇÕES DOS ACESSÓRIOS

Joelheiras - 1 par  
Cotoveleiras - 1par

## Capacete Little child play

ABERTURAS DE CIRCULAÇÃO DE AR	11
CONSTRUÇÃO	Pvc + Eps
SISTEMA DE FECHAMENTO	Fivela
SISTEMA REGULÁVEL	Sim
CONSTRUÇÃO SISTEMA DE REGULAGEM	Ajustável na fivela
ESPUMA LAVÁVEL	Sim
VISEIRA	Não possui
FAIXA REFLETIVA	Não possui
CODIGO:	25017 - PT 25016 - VM



RAVA

## Capacete little child fan

ABERTURAS DE CIRCULAÇÃO DE AR	6
CONSTRUÇÃO	Pvc + Eps
SISTEMA DE FECHAMENTO	Fivela
SISTEMA REGULÁVEL	Sim
CONSTRU SISTEMA DE REGULAGEM	Ajustável na fivela
VISEIRA	Não possui
FAIXA REFLETIVA	Não possui
CODIGO:	25020 - AZ 25024 - LJ 25022 - FLOWERS 25021 - BALL CORES 25023 - MELÂNCIA



FOTOS MERAMENTE ILUSTRATIVAS. AS INFORMAÇÕES/CONFIGURAÇÕES DE PRODUTOS PODERÃO SOFRER ALTERAÇÕES SEM AVISO PRÉVIO.

ENTRE EM CONTATO COM O SEU CONSULTOR OU FALE COM O NOSSO TIME DE TELEVENDAS PELO (33) 3277-3030.

### Viseira Plástica para Capacete Space New Rava

**CARACTERÍSTICA** Nylon

**EMBALAGEM** 10 peças

12418



### Carneira Plástica para Capacete Space New Rava

**CARACTERÍSTICA** Para ajuste de capacete

**MATERIAL** Nylon

**EMBALAGEM** 10 peças

12419



### Viseira para Capacete Rava Space

- CARACTERÍSTICA**
- Viseira para capacete rava
  - Compatível com capacete rava space
  - Encaixe lateral por pressão
  - Material nylon

**EMBALAGEM** 10 peças

11123



**RAVA**

## Espuma interna para capacete Space New Rava

**CARACTERÍSTICA** Espuma interna para capacete  
Space New Rava

**EMBALAGEM** 5 peças

12417



## Terminal Passa Cabo Cego Quadro Rava

**CARACTERÍSTICA** Compatível com Jump e Storm linha  
2019/2020 / Ride Plus, Hunch e  
Hunch Plus, Stamina, Jump e Hurry  
linha 2021/2022

**MATERIAL** Nylon

**FATOR** 20

**EMBALAGEM** 500 peças

17801



## Terminal Passa Cabo Encaixo Quadro Rava

**CARACTERÍSTICA** Compatível com Jump e Storm linha  
2019/2020 / Ride Plus, Hunch e  
Hunch Plus, Stamina, Jump e Hurry  
linha 2021/2022

**MATERIAL** Nylon

**FATOR** 20

**EMBALAGEM** 500 peças

17251



## Terminal Passa Cabo Quadro Pt Alum. Rava

### CARACTERÍSTICA

- Passagem para dois cabos
- Acompanha parafuso
- Compatível com quadro TSW Yukon

### MATERIAL

Alumínio

### PESO

28gr - peso referente a sacolinha com 10 unidades

### FATOR

10

### EMBALAGEM

100 peças

20328



## Terminal Passa Cabo Quadro Duplo Pt Rava

### CARACTERÍSTICA

- Passagem para dois cabos
- Fixado por pressão
- Compatível com quadro TSW Hunch e Hunch Plus

### MATERIAL

Nylon

### PESO

12gr - peso referente a sacolinha com 20 unidades

### FATOR

20

### EMBALAGEM

100 peças

20329



## Terminal Passa Cabo Quadro Triplo Pt Rava

### CARACTERÍSTICA

- Passagem para até 3 cabos
- Fixado por pressão

### MATERIAL

Borracha

### PESO

52gr - peso referente a sacolinha com 20 unidades

### FATOR

20

### EMBALAGEM

100 peças

24145





### | Selim assento diant. Bicicleta c/ suporte

#### MODELO

- Selim assento dianteiro RAVA
- Selim com castanha em aço
- Suporte com proteção para chassi
- Fixação no Top Tube com Down Tube
- Acompanha ferramenta para instalação
- Suporte de Apoio para as mãos
- Suporte com apoio para os pés com presilha
- Acompanha manual de instalação

#### MATERIAL

Polímero e aço

#### PESO

1.515 Kg (Referente ao kit Completo)

#### EMBALAGEM

25 unidades

23831



### Selim mtb gel preto mod. 3

**MODELO**

- Vazado
- estrutura do assento em polímero, espuma e couro sintético
- Excelente acabamento
- Não acompanha castanha

**MATERIAL**

Polímero e aço

**TAMANHO**

275 x 160 mm

**PESO**

358g

**EMBALAGEM**

30 peças

■ 23273



### Selim mtb "sedna" vazado preto

**MODELO**

- Vazado
- estrutura do assento em polímero, espuma e couro sintético
- Excelente acabamento
- Com castanha

**MATERIAL**

Polímero e aço

**TAMANHO**

275 x 150 mm

**PESO**

432g peso referente ao selim com castanha

**EMBALAGEM**

30 peças

■ 23269



### Selim mtb "marte" preto gel

**MODELO**

- Vazado
- estrutura do assento em polímero, espuma e couro sintético
- Excelente acabamento
- Com castanha

**MATERIAL**

Polímero e aço

**TAMANHO**

270 x 160 mm

**PESO**

532g peso referente ao selim com castanha

**EMBALAGEM**

30 peças

23224



### Selim mtb "ceres" gel preto

**MODELO**

- Vazado
- estrutura do assento em polímero, espuma e couro sintético
- Excelente acabamento
- Com castanha

**MATERIAL**

Polímero e aço

**TAMANHO**

275 x 160 mm

**PESO**

558g peso referente ao selim com castanha

**EMBALAGEM**

30 peças

23267





### Selim Júnior Rava

**MODELO** Com castanha | trilhos de aço

**MATERIAL** Polímero e aço

**TAMANHO** 245 x 140 mm

**PESO** 253g (com castanha)

**EMBALAGEM** 50 peças

 23261

 23262

 23263

 23264

### Selim mtb "neptuno" preto

**MODELO**

- Vazado
- estrutura do assento em polímero, espuma e couro sintético
- Excelente acabamento
- Não acompanha castanha

**MATERIAL** Polímero e aço

**TAMANHO** 275 x 160 mm

**PESO** 462g peso referente ao selim com castanha

**EMBALAGEM** 30 peças

 23266



FOTOS MERAMENTE ILUSTRATIVAS. AS INFORMAÇÕES/CONFIGURAÇÕES DE PRODUTOS PODERÃO SOFRER ALTERAÇÕES SEM AVISO PRÉVIO.

ENTRE EM CONTATO COM O SEU CONSULTOR OU FALE COM O NOSSO TIME DE TELEVENDAS PELO (33) 3277-3030.

**RAVA**

## Selim cross "eris" frestyle preto

<b>CARACTERÍSTICA</b>	Selim Bmx   Linha Rava
	<ul style="list-style-type: none"><li>• Selim Bmx Rava</li><li>• Trilho Em Aço</li><li>• Estrutura Do Assento Em Polímero, Espuma E Couro Sintético</li><li>• Excelente Acabamento</li><li>• Acompanha Castanha Para Fixação No Canote</li><li>• Largura 148mm</li><li>• Comprimento 230mm</li></ul>

<b>MATERIAL</b>	Espuma/ Couro Sintético
-----------------	-------------------------

<b>TRILHO</b>	Aço
---------------	-----

<b>TAMANHO</b>	148mm x 230mm
----------------	---------------

<b>PESO</b>	386g - Selim com a castanha
-------------	-----------------------------

<b>EMBALAGEM</b>	30 unidades
------------------	-------------

23225



## Selim 02 molas c/ castanha big preto

<b>CARACTERÍSTICA</b>	<ul style="list-style-type: none"><li>• Selim Rava</li><li>• Trilho Em Aço</li><li>• Com 02 Molas Em Aço</li><li>• Estrutura Do Assento Em Polímero, Espuma E Couro Sintético</li><li>• Excelente Acabamento</li><li>• Acompanha Castanha Para Fixação No Canote</li><li>• Largura 205mm</li><li>• Comprimento 240mm</li></ul>
-----------------------	--

<b>MATERIAL</b>	Espuma/ Couro Sintético
-----------------	-------------------------

<b>TRILHO</b>	Aço
---------------	-----

<b>TAMANHO</b>	240mm x 205mm
----------------	---------------

<b>PESO</b>	668g - Selim com a castanha
-------------	-----------------------------

<b>EMBALAGEM</b>	30 unidades
------------------	-------------

23260



## | Selim big c/ castanha e elastômero

### CARACTERÍSTICA

- Selim Rava
- Trilho Em Aço
- Com 02 Molas Em Elastômero
- Estrutura Do Assento Em Polímero, Espuma E Couro Sintético
- Excelente Acabamento
- Acompanha Castanha Para Fixação No Canote
- Largura 205mm
- Comprimento 240mm

### MATERIAL

Espuma/ Couro Sintético

### TRILHO

Aço

### TAMANHO

240mm x 205mm

### PESO

635g - Selim com a castanha

### EMBALAGEM

30 unidades

23265



## | Selim mtb “mercúrio” largo preto

### CARACTERÍSTICA

- Selim Rava
- Trilho Em Aço
- Vazado
- Suporte Auxiliar Na Parte De Trás
- Estrutura Do Assento Em Polímero, Espuma E Couro Sintético
- Excelente Acabamento
- Acompanha Castanha Para Fixação No Canote
- Largura 205mm
- Comprimento 268mm

### MATERIAL

Espuma/ Couro Sintético

### TRILHO

Aço

### TAMANHO

268mm x 205mm

### PESO

548g - Selim com a castanha

### EMBALAGEM

30 Unidades

23268



RAVA

## Selim passeio "leonis" preto

### CARACTERÍSTICA

- Selim Rava
- Trilho Em Aço
- Estrutura Do Assento Em Polímero, Espuma E Couro Sintético
- Excelente Acabamento
- Acompanha Castanha Para Fixação No Canote
- Largura 185mm
- Comprimento 265mm

### MATERIAL

Espuma/ Couro Sintético

### TRILHO

Aço

### TAMANHO

185mm x 265mm

### PESO

494g - Selim com a castanha

### EMBALAGEM

30 unidades

23270



## Selim mtb preto mod 1

### CARACTERÍSTICA

- Selim Rava
- Trilho Em Aço
- Estrutura Do Assento Em Polímero, Espuma E Couro Sintético
- Excelente Acabamento
- Largura 160mm
- Comprimento 275mm

### MATERIAL

Espuma/ Couro Sintético

### TRILHO

Aço

### TAMANHO

160mm x 275mm

### PESO

336g

### EMBALAGEM

30 unidades

23271



## Selim mtb preto mod 2

### CARACTERÍSTICA

- Selim Rava
- Vazado
- Trilho Em Aço
- Estrutura Do Assento Em Polímero, Espuma E Couro Sintético
- Excelente Acabamento
- Largura 160mm
- Comprimento 275mm

### MATERIAL

Espuma/ Couro Sintético

### TRILHO

Aço

### TAMANHO

160mm x 275mm

### PESO

335g

### EMBALAGEM

30 unidades

23272



RAVA

## Selim mtb gel preto mod. 4

### MODELO

- Vazado
- estrutura do assento em polímero, espuma e couro sintético
- Excelente acabamento
- Não acompanha castanha

### MATERIAL

Polímero e aço

### TAMANHO

275 x 160 mm

### PESO

360g

### EMBALAGEM

30 peças

23274





**Kit Chaveiro Multifunção 12 Funções Rava**

**CARACTERÍSTICA** 12 funções

**FUNÇÕES** Extrator de corrente | Allen 1.5, 2, 3, 4, 5, 6, 8 mm | PH 1 | Torx T25 | Fenda 1.0 x 5 mm | Canhão 7 mm

**MATERIAL** Alumínio

**EMBALAGEM** 100 peças

■ 3979

■ 4983



**Alicate para Corrente Rava**

**CARACTERÍSTICA** Trava e destrava Missing Link

**EMBALAGEM** 10 peças

13187



**Alicate para Destruvar Corrente Rava**

**CARACTERÍSTICA** Destrava Missing Link

**EMBALAGEM** 10 peças

16097



**Extrator de Pedivela Rava**

**CARACTERÍSTICA** Extrator de Pedivela triplo | Ponta Quadrada

**EMBALAGEM** 50 Peças

22705





### Kit Chaveiro Multifunção 07 Funções Rava

<b>CARACTERÍSTICA</b>	07 funções
<b>FUNÇÕES</b>	Allen 2,5, 3, 4, 5, 6 mm   Chave Philips   Chave de Fenda
<b>MATERIAL</b>	Alumínio
<b>EMBALAGEM</b>	100 peças
	16214
	16213



### Extrator movimento central

<b>CARACTERÍSTICA</b>	Integrado
<b>EMBALAGEM</b>	50 peças
	04009



### Extrator pedal TSW / RAVA

<b>CARACTERÍSTICA</b>	9/16 - 15 - 24mm
<b>EMBALAGEM</b>	50 peças
	04010



### Extrator TSW / RAVA

<b>CARACTERÍSTICA</b>	Extrator pedal   Parafuso eixo central
<b>EMBALAGEM</b>	50 peças
	04002



### Espátula nylon

<b>CARACTERÍSTICA</b>	Para retirar câmara   2 peças
<b>EMBALAGEM</b>	50 peças
	04001

**RAVA**



### Kit chaveiro allen

CARACTERÍSTICA 9 funções

EMBALAGEM 50 peças

04631



### Alicate corte cabo tsw / rava

CARACTERÍSTICA Para corte cabo de aço

EMBALAGEM 50 peças

04011



### Kit chaveiro allen

CARACTERÍSTICA 9 funções

EMBALAGEM 50 peças

04982



### Extrator corrente corrida tsw / rava

CARACTERÍSTICA Extrator de corrente

EMBALAGEM 100 peças

04004



### Extrator roda livre tsw / rava

CARACTERÍSTICA Chave de extrair roda livre/Cassete

EMBALAGEM 50 peças

04012



### Extrator corrente tsw / rava

CARACTERÍSTICA Extrator de corrente

EMBALAGEM 100 peças

04003



### Chave de raio tsw / rava

CARACTERÍSTICA 10/11/12/14/15G

EMBALAGEM 50 peças

04006



### Extrator de roda tsw / rava

CARACTERÍSTICA Extrator de Roda livre 22.5mm

EMBALAGEM 50 peças

03997



### Extrator de movimento central

CARACTERÍSTICA Central Selado

EMBALAGEM 100 peças

03996



### Extrator de roda

CARACTERÍSTICA Extrator de Roda livre 4 Pinos

EMBALAGEM 50 peças

04000



### Extrator cassete tsw / rava

CARACTERÍSTICA Extrator Cassete e Disco Center Lock 23.5mm | Com guia

EMBALAGEM 50 peças

03999



### Extrator cassete tsw / rava

CARACTERÍSTICA Extrator Cassete e Disco Center Lock 23mm

EMBALAGEM 50 peças

03998



### Extrator de pedivela tsw / rava

CARACTERÍSTICA Triplo - Central quadrada

EMBALAGEM 50 peças

04005

RAVA



## Smart Tools Case Rava

**CARACTERÍSTICA** 14 peças | Para remoção e instalação de rolamentos

**CONTEÚDO** Allen 8 mm | Arruela | Cilindro | Engate 22/24 mm | Engate 22/30 mm | Engate 25/30 mm | Pinça | Parafuso hexagonal | Tampa hexagonal | Tampa 45 mm | Tampa 53 mm | 3 puxadores de fenda

**EMBALAGEM** 5 peças

13184

RAVA



FOTOS MERAMENTE ILUSTRATIVAS. AS INFORMAÇÕES/CONFIGURAÇÕES DE PRODUTOS PODERÃO SOFRER ALTERAÇÕES SEM AVISO PRÉVIO.

ENTRE EM CONTATO COM O SEU CONSULTOR OU FALE COM O NOSSO TIME DE TELEVENDAS PELO (33) 3277-3030.



## Smart Tools Pocket Rava

**CARACTERÍSTICA** 20 funções

**FUNÇÕES** Chave de rosca 5, 8(2x) e 10 mm | Chave de raio(3x) | Chave de raio Mavic (2x) | Allen 2(2x), 2.5, 4, 5, 6 e 8 mm | T25 | PH2 | Fenda 5 mm | Chave de corrente

**MATERIAL** Alumínio

**PESO** 0.12 Kg

**EMBALAGEM** 10 peças

13186



**RAVA**

FOTOS MERAMENTE ILUSTRATIVAS. AS INFORMAÇÕES/CONFIGURAÇÕES DE PRODUTOS PODERÃO SOFRER ALTERAÇÕES SEM AVISO PRÉVIO.

ENTRE EM CONTATO COM O SEU CONSULTOR OU FALE COM O NOSSO TIME DE TELEVENDAS PELO (33) 3277-3030.



## Suporte Oficina para Montagem de Bicicleta Rava

**CARACTERÍSTICA** Altura regulável: mínimo 104 cm / 198 cm máximo | Quadripé retrátil | Braço de apoio com mandíbula | Mandíbula com abertura de 75 mm | Haste de fixação | Giro 360°

**COMPLEMENTOS** Suporte para ferramentas | Barra de Imã | Chave allen 5 mm

**CARGA SUPORTADA** 30 kg

**MATERIAIS** Aço | Plástico | Borracha

**EMBALAGEM** 1 peça

18075



## Porta Ferramentas Save Tools Rava

**CARACTERÍSTICA** Ideal para transportar câmara de ar | Ferramentas | Chaves e suplementos

**MATERIAL** Plástico

**TAMANHO** ø 7,5 cm | Altura: 13,5 cm

**EMBALAGEM** 01 peça

14705





## Suporte Oficina para Montagem de Bicicleta Modelo 2 Rava

### CARACTERÍSTICA

Suporte manutenção profissional para reparo em bicicleta;  
Material principal: Aço Carbono e Polímero Termoplástico | Peso do Produto: 4.630 gramas | Fixação da bicicleta pelo quadro ou através do canote;  
Encaixe em diferentes formatos de tubos até 60mm (diâmetro);  
Altura Regulável de 120cm até 170cm;  
Acompanha Bandeja e chave para montagem do suporte;

### COMPLEMENTOS

Acompanha suporte estabilizador de guidão | De fácil montagem; Compacto quando dobrado | Liberação rápida & altura ajustável | A abraçadeira gira 360°, isso significa que o operador pode escolher o melhor ângulo para manutenção | Design inovador de duas pernas, eficiente e muito estável

### CARGA SUPORTADA

27 kg

### MATERIAIS

Aço Carbono e Polímero Termoplástico

### EMBALAGEM

1 peça

20969



**RAVA**

## Suporte Bicicleta vertical mod 01

### CARACTERÍSTICA

- Suporte expositor RAVA
- Material Aço
- Alta qualidade
- Resistente
- Excelente Acabamento
- Fixação por parafuso
- Suporte da roda articulado
- Vertical
- Proteção para o Aro

### MATERIAL

Aço

### PESO

+556 Gr - incluindo parafusos

### EMBALAGEM

10 peças

23219



## Suporte Expositor Bicicleta Roda Traseira. Cavalete

### CARACTERÍSTICA

- Suporte expositor RAVA
- Material Aço
- Alta qualidade
- Resistente
- Excelente Acabamento
- Suporte articulado
- Regulável 26"/ 27.5"/ 29"
- Horizontal
- Fixação no eixo da roda
- Fixadores do eixo de nylon

### MATERIAL

Aço

### PESO

+700 Gr

### EMBALAGEM

10 peças

23220





## Descanso Traseiro MTB Modelo 06 Rava

<b>CARACTERÍSTICA</b>	Fixação lateral por parafuso (chainstay)   Para Bicicletas aro 26"
<b>COMPATIBILIDADE</b>	Compatível com bicicletas Rava Bolt, Rava Way 26" e TSW Orla
<b>MATERIAL</b>	Aço e nylon
<b>PESO</b>	247 Gr - incluindo parafusos de fixação
<b>EMBALAGEM</b>	50 peças 20147



## Descanso central mtb modelo 01

<b>CARACTERÍSTICA</b>	<ul style="list-style-type: none"><li>• Descanso central rava</li><li>• Material alumínio</li><li>• Alta qualidade</li><li>• Resistente</li><li>• Excelente acabamento</li></ul>
<b>COMPATIBILIDADE</b>	<ul style="list-style-type: none"><li>• Fixação por parafuso (instalação no chainstay)</li><li>• Sistema de regulação de altura</li></ul>
<b>MATERIAL</b>	Alumínio
<b>PESO</b>	+260gr
<b>EMBALAGEM</b>	50 peças 23216



**RAVA**

## Descanso lateral mtb modelo 04

<b>CARACTERÍSTICA</b>	<ul style="list-style-type: none"><li>• Descanso lateral rava</li><li>• Material aço</li><li>• Alta qualidade</li><li>• Resistente</li><li>• Excelente acabamento</li></ul>
<b>COMPATIBILIDADE</b>	<ul style="list-style-type: none"><li>• Fixação por parafuso (instalação no chainstay e seat stay)</li><li>• Sistema de regulação de altura</li></ul>
<b>MATERIAL</b>	Aço
<b>PESO</b>	-
<b>EMBALAGEM</b>	50 peças 23217



FOTOS MERAMENTE ILUSTRATIVAS. AS INFORMAÇÕES/CONFIGURAÇÕES DE PRODUTOS PODERÃO SOFRER ALTERAÇÕES SEM AVISO PRÉVIO.

ENTRE EM CONTATO COM O SEU CONSULTOR OU FALE COM O NOSSO TIME DE TELEVENDAS PELO (33) 3277-3030.

## Terminal Passa Cabo Quadro Rava

### CARACTERÍSTICA

Terminal passa cabo duplo em alumínio Rava | Kit com 5 unidades | Acompanha parafuso para instalação | Preta

### COMPATIBILIDADE

Compatível com quadro TSW YUKON e RAVA CAVE BOOST

### DIMENSÕES

32 x 9 x 6.5 mm (Comprimento X Largura X Altura)

### MATERIAL

Alumínio

### PESO

2 gr (peso da unidade)

### EMBALAGEM

200 peças

20489

## Descanso lateral mtb modelo 05

### CARACTERÍSTICA

- Descanso lateral rava
- Material aço
- Alta qualidade
- Resistente
- Excelente acabamento

### COMPATIBILIDADE

- Fixação por parafuso (instalação no chainstay)
- Sistema de regulagem de altura

### MATERIAL

Aço

### PESO

-

### EMBALAGEM

50 peças

23218



## Suporte Expositor Bicicleta Roda Tras.

**CARACTERÍSTICA** Base de apoio emborrachada, desmontável, suporte individual. Fenda do pneu: 60mm

**COMPATIBILIDADE** Bicicleta de aro 20" a 29"

**DIMENSÕES** 430 x 380 x 760 mm (Comprimento X Largura X Altura)

**MATERIAL** Aço

**PESO** 1.95 Kg (peso da unidade)

**EMBALAGEM** 1 peça

23798

RAVA

C A T Á L O G O

**X-TIME**

---

T R A N S M I S S Õ E S



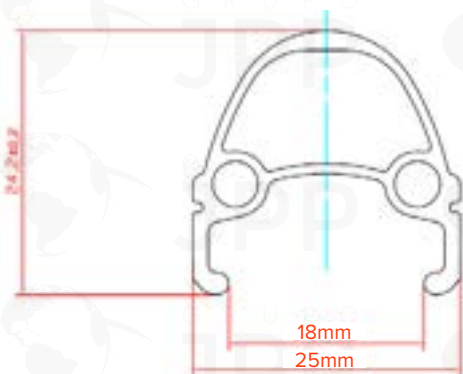

**ARO 29 X 32F ALUM MTB PRETO F. XT 1000 IMP.**

<b>MATERIAL</b>	Alumínio anodizado
<b>CARACTERÍSTICA</b>	<ul style="list-style-type: none"> <li>• x-time xt1000</li> <li>• alumínio 6061</li> <li>• acabamento anodizado</li> <li>• largura externa 25mm</li> <li>• largura interna 18mm</li> <li>• perfil duplo</li> <li>• 32 furos</li> <li>• disc brake</li> <li>• largura do pneu 25mm – 55mm (1.0" – 2.2")</li> <li>• disponível com válvula americana</li> </ul>
<b>PESO</b>	572g
<b>EMBALAGEM</b>	10 unidades
	22831

FOTOS MERAMENTE ILUSTRATIVAS. AS INFORMAÇÕES/CONFIGURAÇÕES DE PRODUTOS PODERÃO SOFRER ALTERAÇÕES SEM AVISO PRÉVIO.

ENTRE EM CONTATO COM O SEU CONSULTOR OU FALE COM O NOSSO TIME DE TELEVENDAS PELO (33) 3277-3030.

## Alavanca CÂMBIO EZ-FIRE 21V. PRETA

### CARACTERÍSTICA

- Conjunto de alavanca 21v ez-fire
- Material alumínio
- Alta qualidade
- Resistente
- Excelente acabamento
- Manetes de alumínio
- Sistema de transmissão 3x7v
- Acompanha cabos de marcha

PESO APROXIMADO +/- 342 g

EMBALAGEM 25 unidades

23221



## Alavanca CÂMBIO EZ-FIRE 24V. PRETA

### CARACTERÍSTICA

- Conjunto de alavanca 24v ez-fire
- Material alumínio
- Alta qualidade
- Resistente
- Excelente acabamento
- Manetes de alumínio
- Sistema de transmissão 3x8v
- Acompanha cabos de marcha

PESO APROXIMADO +/- 342 g

EMBALAGEM 25 unidades

23222



## Conjunto De Câmbio 3X7 VEL. XTIME

### CARACTERÍSTICA

- Conjunto de alavanca 21v ez-fire
- Material alumínio/aço
- Alta qualidade
- Resistente
- Excelente acabamento
- Manetes de alumínio
- Câmbio traseiro de 7 velocidades (fixação direta – parafuso na gancheira do quadro)
- Câmbio dianteiro de 3 velocidades (abraçadeira 31.8mm / down pull)
- Sistema de transmissão 3x7v
- Acompanha cabos de marcha

PESO APROXIMADO +728gr - peso referente ao kit

EMBALAGEM 25 unidades

23223





**Alavanca Câmbio EZ-FIRE 24v**

**CARACTERÍSTICA** Com manetes de alumínio | Cabos e conduítes

**EMBALAGEM** 25 peças

03613

**Alavanca Câmbio EZ-FIRE 21v**

**CARACTERÍSTICA** Com manetes de alumínio | Cabos e conduítes

**EMBALAGEM** 25 peças

00150/20512



## Roldana X-Time 12 dentes | Alumínio/Cerâmica

ROLAMENTO	Cerâmica
MATERIAL	Alumínio
NÚMERO DE DENTES	12
DIÂMETRO	46.7 mm
ESPESSURA DO DENTE	1.9 mm
COMPATIBILIDADE	Sram GX e SX
PESO	13 g
EMBALAGEM	25 peças

15025



## Roldana X-Time 14 dentes | Alumínio/Cerâmica

ROLAMENTO	Cerâmica
MATERIAL	Alumínio
NÚMERO DE DENTES	14
DIÂMETRO	55.5 mm
ESPESSURA DO DENTE	1.9 mm
COMPATIBILIDADE	Sram GX e SX
PESO	13 g
EMBALAGEM	25 peças

15027



FOTO ILUSTRATIVA  
DA EMBALAGEM



## Roldana X-Time 12 dentes | Alumínio

ROLAMENTO	Comum
MATERIAL	Alumínio
NÚMERO DE DENTES	12
DIÂMETRO	46.7 mm
ESPESSURA DO DENTE	1.9 mm
COMPATIBILIDADE	Sram GX e SX
PESO	13 g
EMBALAGEM	25 peças

15024





## Roldana X-Time 13 dentes | Alumínio

ROLAMENTO	Comum
MATERIAL	Alumínio
NÚMERO DE DENTES	13
DIÂMETRO	49.4 mm
ESPESSURA DO DENTE	1.9 mm
COMPATIBILIDADE	Shimano XTR, XT, SLX, Deore 12 velocidades
PESO	13 g
EMBALAGEM	25 peças

15030



## Roldana X-Time 14 dentes | Alumínio

ROLAMENTO	Comum
MATERIAL	Alumínio
NÚMERO DE DENTES	13
DIÂMETRO	55.5 MM
ESPESSURA DO DENTE	1.9 mm
COMPATIBILIDADE	Sram GX e SX
PESO	13 g
EMBALAGEM	25 peças

15026



FOTO ILUSTRATIVA DA EMBALAGEM



## Roldana X-Time 11 dentes | Nylon

ROLAMENTO	Comum
MATERIAL	Nylon
NÚMERO DE DENTES	11
DIÂMETRO	42 mm
ESPESSURA DO DENTE	2.2 mm
COMPATIBILIDADE	Shimano ALTUS RD-M200, ALÍVIO RD-M4000, ALÍVIO RD-M3100, SLX RD-M7000, XT RD-M8000, CLARIS RD-R2000, SORA RD-R3000 e 105 RD-R7000
PESO	8 g
EMBALAGEM	25 peças

15031



## Roldana X-Time 12 dentes | Nylon

ROLAMENTO	Comum
MATERIAL	Nylon
NÚMERO DE DENTES	12
DIÂMETRO	50.5 mm
ESPESSURA DO DENTE	2.5 e 3.7 mm
PESO	10g
EMBALAGEM	25 peças
	15029



## Roldana X-Time 13 dentes | Nylon

ROLAMENTO	Comum
MATERIAL	Nylon
NÚMERO DE DENTES	13
DIÂMETRO	49.5 mm
ESPESSURA DO DENTE	2.45 mm
COMPATIBILIDADE	Altus RD-M310, Tourney RD-A070 e RD-TY 300
PESO	13g
EMBALAGEM	25 peças
	15028



## Pedivela Single com Engrenagem 32T

CARACTERÍSTICA	Com braço   Compatível com central ponta quadrada
MATERIAL PEDIVELA	Alumínio
MATERIAL ENGENHAGEM	Aço
ENGENHAGEM	32D
BCD	104 mm
COMPRIMENTO DO BRAÇO	170 mm
EMBALAGEM	5 peças
PESO	0.78 kg (com engrenagem 32D aço)
	18119



X-TIME

## Engrenagem Tripla com Braço 42/34/24

**CARACTERÍSTICA** Com braço e protetor de coroa | Compatível com central ponta quadrada  
Braço: Alumínio  
Engrenagem: Aço

**ENGENHAGENS** 42/34/24D

**COMPRIMENTO DO BRAÇO** 170 mm

**PESO** 803 g

**EMBALAGEM** 5 peças

15470



## Pedivela Direct Mount X-Time com engrenagem

**CARACTERÍSTICA** Direct mount | Com engrenagem | Material de alta resistência e rigidez | Eixo Ø 24 x 120 mm

**MATERIAL** Alumínio

**COMPRIMENTO DO BRAÇO** 170 mm

**ENGENHAGENS COMPATÍVEIS** Xtime e Sram®

**ALINHAMENTO DA CORRENTE** 49 mm | 52 mm (boost)

**MOVIMENTO CENTRAL** BSA Ø 24 mm

**PESO** 780 g (C/ engrenagem 32T)

**EMBALAGEM** 5 peças

**170 MM** 18120



## Engrenagem alum. C/ braço Off set 3mm integ. Xt

CARACTERÍSTICA	Engrenagem com braço xtime   coroa direct mount em alumínio   braço em alumínio
MATERIAL	Alumínio / Aço
COMPRIMENTO DO BRAÇO	170 mm
EIXO DE AÇO	Ø24x120mm
ENGRENAGENS COMPATÍVEIS	Xtime e Sram®
ALINHAMENTO DA CORRENTE	49 mm   52 mm (boost)
MOVIMENTO CENTRAL	BSA Ø 24 mm
PESO	850gr - peso referente engrenagem completa e movimento central
EMBALAGEM	5 peças
CÓDIGO	22760 - 30D 22759 - 32D



XTIME

## Engrenagem Dupla 39/53D Speed

CARACTERÍSTICA	Com braço 170mm
BCD	130 mm
MATERIAL	Alumínio
COROA	Aço
EMBALAGEM	10 peças
130 MM	12660



FOTOS MERAMENTE ILUSTRATIVAS. AS INFORMAÇÕES/CONFIGURAÇÕES DE PRODUTOS PODERÃO SOFRER ALTERAÇÕES SEM AVISO PRÉVIO.

ENTRE EM CONTATO COM O SEU CONSULTOR OU FALE COM O NOSSO TIME DE TELEVENDAS PELO (33) 3277-3030.

## Engrenagem Tripla C/ Braço 24/34/42d. Presta

### CARACTERÍSTICA

- Engrenagem Tripla Com Braço
- Material Aço Revestido Com Nylon
- Coroas Fixas (42/34/24d.)
- Protetor De Coroa
- Sistema De Encaixe Compatível Com Eixo Central Ponta Quadrada
- Diâmetro Da Rosca Do Pedal 9/16 (Inglês)
- Comprimento Do Braço 170mm
- Indexada

### MATERIAL

Aço Revestido De Nylon

### ENGENHAGENS

42 | 34 | 24 D

### PESO

1.086 gr

### EMBALAGEM

12 Unidades

23205



## Engrenagem Tripla 24/34/42D

### CARACTERÍSTICA

Engrenagem tripla com braço | Coroa fixas | Possui protetor de coroa | Sistema de encaixe compatível com eixo central ponta quadrada | Diâmetro da rosca do pedal 9/16 (Inglês) | INDEX

### ENGENHAGENS

42/34/24D

### COMPRIMENTO DO BRAÇO

170 mm

### MATERIAL

Aço/Nylon

### PESO

1098 gr

### EMBALAGEM

12 peças

18224



## Engrenagem Tripla 24/34/42D

### CARACTERÍSTICA

Engrenagem tripla com braço | Coroa fixa | Possui protetor de coroa | Sistema de encaixe compatível com eixo central ponta quadrada | Diâmetro da rosca do pedal 9/16 (Inglês) | INDEX

### ENGENHAGENS

42/34/24D

### COMPRIMENTO DO BRAÇO

170 mm

### MATERIAL

Aço/Nylon

### PESO

1106 gr

### EMBALAGEM

12 peças

18225



## Engrenagem Tripla 28/38/48D

### CARACTERÍSTICA

Engrenagem tripla com braço | Coroa fixa | Possui protetor de coroa | Sistema de encaixe compatível com eixo central ponta quadrada | Diâmetro da rosca do pedal 9/16 (Inglês) | INDEX

### ENGENHAGENS

48/38/28D

### COMPRIMENTO DO BRAÇO

170 mm

### MATERIAL

Aço/Nylon

### PESO

1158 gr

### EMBALAGEM

12 peças

18226



X-TIME

## Engrenagem Tripla 28/38/48D

### CARACTERÍSTICA

Engrenagem tripla com braço | Coroa fixa | Possui protetor de coroa | Sistema de encaixe compatível com eixo central ponta quadrada | Diâmetro da rosca do pedal 9/16 (Inglês) | INDEX

### ENGRENAGENS

48/38/28D

### COMPRIMENTO DO BRAÇO

170 mm

### MATERIAL

Aço/Nylon

### PESO

1160 gr

### EMBALAGEM

12 peças

19686



## Parafuso Eixo Centro

### CARACTERÍSTICA

Allen | Com Retentor

### FATOR

10

### EMBALAGEM

100 peças

### 08MM

13107

### 12MM

13105

### 15MM

13106



8 MM



12 MM



15 MM

## Parafuso Eixo Centro

### CARACTERÍSTICA

Allen

### COMPATÍVEL

Pedivela X-Time (15mm) 11S

### EMBALAGEM

20 peças

### FATOR

5

13091



## Parafuso Fixação Engrenagem

CARACTERÍSTICA	Sextavado
MATERIAL	Inox/Aço carbono
MEDIDA	8 mm
EMBALAGEM	10 peças
	06123
OBSERVAÇÃO	Sem logo

DUPLA/TRIPLA



SUGESTÃO ENGRENAGEM PEDIVELA

X-TIME 08275 (Duplo)  
08275 (Triplo)



## Parafuso Eixo Centro Alum.

CARACTERÍSTICA	Parafuso eixo do braço do pedivela Diâmetro da bitola 27mm Bitola Allen Øm19 Torque recomendado 4-5n.M Possui bucha interna de segurança
MATERIAL	Alumínio
PESO	18gr
MEDIDA	17 mm
EMBALAGEM	100 peças



23848

X-TIME

## Corrente 12S 128L X-Time

CARACTERÍSTICA	Corrente 12S 128L X-Time Missing link 12V. - SUMC (power link)
MATERIAL	Aço
PESO	270g
EMBALAGEM	50 peças

19154



FOTOS MERAMENTE ILUSTRATIVAS. AS INFORMAÇÕES/CONFIGURAÇÕES DE PRODUTOS PODERÃO SOFRER ALTERAÇÕES SEM AVISO PRÉVIO.

ENTRE EM CONTATO COM O SEU CONSULTOR OU FALE COM O NOSSO TIME DE TELEVENDAS PELO (33) 3277-3030.



## Parafuso Allen para Fixação Engrenagem

<b>CARACTERÍSTICA</b>	Allen
<b>MATERIAL</b>	Inox
<b>MEDIDA</b>	6 mm
<b>EMBALAGEM</b>	10 peças
	13166
<b>OBSERVAÇÃO</b>	Sem logo



## Engrenagem 32d. Avulsa direct off set 3mm.

<b>CARACTERÍSTICA</b>	<ul style="list-style-type: none"><li>• Padrão sram</li><li>• Disponível em 32d. E 34d.</li><li>• Sistema de fixação direct mount</li></ul>
<b>MATERIAL</b>	Alumínio
<b>ENGENAGENS</b>	32   34 D
<b>PESO</b>	88g referente a engrenagem 32D
<b>EMBALAGEM</b>	10 peças

32D 23845

34D 23846

FOTOS MERAMENTE ILUSTRATIVAS. AS INFORMAÇÕES/CONFIGURAÇÕES DE PRODUTOS PODERÃO SOFRER ALTERAÇÕES SEM AVISO PRÉVIO.

ENTRE EM CONTATO COM O SEU CONSULTOR OU FALE COM O NOSSO TIME DE TELEVENDAS PELO (33) 3277-3030.



**Engrenagem Direct Single Avulsa MTB Off Set 0 mm**

FOTO ILUSTRATIVA DA EMBALAGEM

<b>CARACTERÍSTICA</b>	Direct mount   Compátivel com Sram®		
<b>MATERIAL</b>	Alumínio		
<b>ENGRENAGENS</b>	32   34   36 D		
<b>PESO</b>	32 - 0.08 kg	<u>32D</u>	18116
	34 - 0.09 kg	<u>34D</u>	18117
	36 - 0.11 kg	<u>36D</u>	18118
<b>EMBALAGEM</b>	10 peças		



FOTOS MERAMENTE ILUSTRATIVAS. AS INFORMAÇÕES/CONFIGURAÇÕES DE PRODUTOS PODERÃO SOFRER ALTERAÇÕES SEM AVISO PRÉVIO.

ENTRE EM CONTATO COM O SEU CONSULTOR OU FALE COM O NOSSO TIME DE TELEVENDAS PELO (33) 3277-3030.



**Engrenagem Single Avulsa BCD Mount MTB**

<b>CARACTERÍSTICA</b>	BCD 96 mm	
<b>MATERIAL</b>	Alumínio 7075	
<b>ENGENHAGENS</b>	32   34   36   38 D	
<b>PESO</b>	com parafuso	sem parafuso
	32 - 68 g	32 - 49 g
	34 - 80 g	34 - 60 g
	36 - 91 g	36 - 72 g
	38 - 102 g	38 - 83 g
<b>EMBALAGEM</b>	10 peças	
<b>32D</b>	15327	
<b>34D</b>	15328	
<b>36D</b>	15329	
<b>38D</b>	15330	

FOTO ILUSTRATIVA DA EMBALAGEM





### Engrenagem **53D Speed**

**CARACTERÍSTICA** 5 Furos avulsa

**BCD** 130 mm

**MATERIAL** Aço

**EMBALAGEM** 1 peça

**130MM** 12884

Obs.: sem logo



### Engrenagem **39D Speed**

**CARACTERÍSTICA** 5 Furos avulsa

**BCD** 110 mm /130 mm

**MATERIAL** Aço

**EMBALAGEM** 1 peça

**130MM** 12882

Obs.: sem logo

### Movimento Central Integrado

**CARACTERÍSTICA** Alumínio

**EMBALAGEM** 1 peça

**COMPATÍVEL** Shimano Hollowtech  
Caixa de Quadro 68 a 73mm

**13110**

**13111**

#### **SUGESTÃO** PEDIVELAS

**SHIMANO** Pedivela integrado 34.7 mm



FOTOS MERAMENTE ILUSTRATIVAS. AS INFORMAÇÕES/CONFIGURAÇÕES DE PRODUTOS PODERÃO SOFRER ALTERAÇÕES SEM AVISO PRÉVIO.

ENTRE EM CONTATO COM O SEU CONSULTOR OU FALE COM O NOSSO TIME DE TELEVENDAS PELO (33) 3277-3030.

## Movimento Central MTB

### CARACTERÍSTICA

Movimento central integrado 34.7mm compatível com Shimano Hollowtech® II para caixa 68/73 mm

### MATERIAL

Alumínio/Plástico

### PESO

114 g (aproximado)

### EMBALAGEM

1 peça

08277



## Eixo Central Selado com Rolamento

CARACTERÍSTICA 34.7 mm | Selado

MODELO Rolamentado

EMBALAGEM 50 peças

110MM 13100/20467

113MM 13101

115MM 20487

119MM 13102

122MM 13103

126MM 13104

## Eixo Centro C/ Rol Salva Quadro

### CARACTERÍSTICA

Movimento central salva quadro estrutura em alumínio e aço comprimento do eixo 122mm compatível com movimento central 34.7 X 68mm | padrão bsa | eixo ponta quadrada | acompanha parafusos para instalação do braço do pedivela

### MATERIAL

Aço/Alumínio

### PESO

284gr - incluindo parafusos

### EMBALAGEM

20 peças

23819





### Movimento Central **BSA/GXP MTB**

**CARACTERÍSTICA** BSA | Ø 24 mm com adaptador para GXP® Ø 22 mm | Caixa quadro: 68 / 73 mm

**MATERIAL** Alumínio/Plástico

**EMBALAGEM** 20 peças

14293



### Adaptador Movimento Central

**CARACTERÍSTICA** PressFit 46 mm para GXP (34.7 mm)

**MATERIAL** Alumínio

**EMBALAGEM** 1 peças

13109



### Guia de Corrente com Abraçadeira

**CARACTERÍSTICA** Guia para correntes 10, 11, ou 12v

**EMBALAGEM** 10 peças

11711

### Guia de Corrente Direct Mount

**CARACTERÍSTICA** Guia para correntes 10, 11, ou 12v  
Compatível com quadros de instalação direta

**EMBALAGEM** 10 peças

11712

**X-TIME**



## Cubo D/T Boost XD Xtime

<b>CARACTERÍSTICA</b>	Par de cubo
<b>CUBO DIANTEIRO</b>	Material alumínio   Eixo 15x110mm   Eixo interno de alumínio   Old 110mm   32 furos   Esferado   Compatível com disco 6 parafusos.
<b>CUBO TRASEIRO</b>	Material alumínio   Eixo 12x148mm   Eixo interno de alumínio   32 furos   02 rolamentos cubo (medida 6903-lu)   02 rolamentos freehub (medidas 6802-lu)   Freehub padrão xd com 3 martelinhos   Compatível com disco 6 parafusos.
<b>MATERIAL</b>	Alumínio/aço.
<b>PESO</b>	545gr - peso referente ao par
<b>FATOR DE VENDA</b>	1 unidade
<b>EMBALAGEM</b>	25 unidades

24374



### Cubo Dianteiro X-Time 32 furos

<b>CARACTERÍSTICA</b>	Dianteiro   Eixo com blocagem   32 furos
<b>EIXO</b>	9 mm
<b>Q.L.D</b>	100 mm
<b>MODELO</b>	Esferado   Freio a disco
<b>MATERIAL</b>	Alumínio
<b>PESO</b>	319 g
<b>EMBALAGEM</b>	1 peça

15592



### Cubo Traseiro X-Time 32 furos

<b>CARACTERÍSTICA</b>	Traseiro   Eixo com blocagem   32 furos
<b>EIXO</b>	9 mm
<b>Q.L.D</b>	135 mm
<b>MODELO</b>	Rosca   Esferado   Freio a disco
<b>MATERIAL</b>	Alumínio
<b>PESO</b>	366 g
<b>EMBALAGEM</b>	1 peça

15593

### Cubo Dianteiro X-Time 36 furos

<b>CARACTERÍSTICA</b>	Dianteiro   Eixo com blocagem   36 furos
<b>EIXO</b>	9 mm
<b>Q.L.D</b>	100 mm
<b>MODELO</b>	Esferado   Freio a disco
<b>MATERIAL</b>	Alumínio
<b>PESO</b>	319 g
<b>EMBALAGEM</b>	1 peça

15590







**Cubo Traseiro X-Time 36 furos**

<b>CARACTERÍSTICA</b>	Traseiro   Eixo com blocagem   36 furos
<b>EIXO</b>	9 mm
<b>O.L.D</b>	135 mm
<b>MODELO</b>	Rosca   Esferado   Freio a disco
<b>MATERIAL</b>	Alumínio
<b>PESO</b>	366 g
<b>EMBALAGEM</b>	1 peça

15591



**Cubo Dianteiro X-Time 32 furos**

<b>CARACTERÍSTICA</b>	Freio a disco 6 parafusos   Eixo furado com blocagem   Rolamento 6200rs
<b>O.L.D</b>	100 mm
<b>MATERIAL</b>	Alumínio   Eixo de aço furado
<b>PESO</b>	330 g
<b>EMBALAGEM</b>	50 peças

19135



**Cubo Traseiro X-Time 32 furos**

<b>CARACTERÍSTICA</b>	Freio a disco 6 parafusos   Eixo furado com blocagem   Rolamento 6200rs   Espaçador
<b>O.L.D</b>	135 mm
<b>MATERIAL</b>	Alumínio   Eixo de aço furado
<b>PESO</b>	379 g
<b>EMBALAGEM</b>	50 peças

19136

### Eixo Dianteiro 3/8 Furado para Blocação e com Rolamento

**CARACTERÍSTICA** 3/8 | Furado para blocação | Rolamentado | 100 mm

**EMBALAGEM** 20 peças

17024

### Eixo Traseiro 3/8 Furado para Blocação e com Rolamento

**CARACTERÍSTICA** 3/8 | Furado para blocação | Rolamentado | 140 mm

**EMBALAGEM** 20 peças

15585

### Eixo Dianteiro 3/8 Furado para Blocação

**CARACTERÍSTICA** 3/8 | Furado para blocação | 100 mm

**EMBALAGEM** 20 peças

17025

### Eixo Traseiro 3/8 Furado para Blocação

**CARACTERÍSTICA** 3/8 | Furado para blocação | 134 mm

**EMBALAGEM** 20 peças

15586

### Blocação de Eixo Traseiro

**CARACTERÍSTICA** Eixo de 135 x 9 mm | Alumínio

**EMBALAGEM** 50 peças

15588

### Blocação de Eixo Dianteiro

**CARACTERÍSTICA** Eixo de 100 x 9 mm | Alumínio

**EMBALAGEM** 50 peças

15587

### Conjunto para **FREIO A DISCO 36 Furos -mecânico** | Dianteiro

<b>PINÇA</b>	Dianteiro   Para freio a disco mecânico   Compatível com de discos de 160 mm   Incluso pastilha
<b>CUBO</b>	Dianteiro   36 furos   Suporte disco de freio parafuso   Eixo de 9 mm   Blocagem   308 g
<b>ROTOR</b>	160 mm   parafuso (6)   2 mm de espessura   138 g
<b>EMBALAGEM</b>	10 peças

13203



### Conjunto para **FREIO A DISCO 36 Furos mecânico** | Traseiro

<b>PINÇA</b>	Traseira   Para freio a disco mecânico   Compatível com de discos de 160 mm   Incluso pastilha
<b>CUBO</b>	Traseiro   36 furos   Suporte disco de freio parafuso   Roda livre   Eixo de 9 mm   349 g
<b>ROTOR</b>	160 mm   parafuso (6)   2 mm de espessura   138 g
<b>EMBALAGEM</b>	10 peças

13204



### Conjunto para **FREIO A DISCO 32 Furos mecânico** | Dianteiro

<b>PINÇA</b>	Dianteiro   Para freio a disco mecânico   Compatível com de discos de 160 mm   Incluso pastilha
<b>CUBO</b>	Dianteiro   32 furos   Suporte disco de freio parafuso   Eixo de 9 mm   Blocagem   308 g
<b>ROTOR</b>	160 mm   parafuso (6)   2 mm de espessura   138 g
<b>EMBALAGEM</b>	10 peças

13205



## Conjunto para **FREIO A DISCO** 32 Furos mecânico | Traseiro

<b>PINÇA</b>	Traseira   Para freio a disco mecânico   Compatível com de discos de 160 mm   Incluso pastilha
<b>CUBO</b>	Traseiro   32 furos   Suporte disco de freio parafuso   Roda livre   Eixo de 9 mm   Blocação   349 g
<b>ROTOR</b>	160 mm   parafuso (6)   2 mm de espessura   138 g
<b>EMBALAGEM</b>	10 peças

13206



## Conjunto de **FREIO A DISCO** hidráulico

<b>CARACTERÍSTICA</b>	Material: Alumínio/Aço Peso: 709 gr (Apenas as manetes)
<b>FREIO DIANTEIRO</b>	Características: X-Time hidráulico   Abraçadeira com dois parafusos   Reservatório de alumínio   Óleo mineral   Caliper 2 pistões   Mangueira com 800 mm Peso: 335 gr
<b>FREIO TRASEIRO</b>	Características: X-Time hidráulico   Abraçadeira com dois parafusos   Reservatório de alumínio   Óleo mineral   Caliper 2 pistões   Mangueira com 1600 mm Peso: 374 gr
<b>DISCOS</b>	Características: X-Time   160 mm   06 parafusos   Aço Peso: 242 gr (Apenas os discos) Observação: Acompanha jogo de parafusos para fixação.
<b>EMBALAGEM</b>	12 peças

08636



## Conjunto de **FREIO A DISCO E CUBO** | Dianteiro/Traseiro

<b>PINÇA</b>	Dianteira/Traseira   Freio a disco mecânico   Incluso pastilhas   Modelo Post mount com adaptador para International Standard
<b>POST MOUNT</b>	Discos de 160 mm
<b>INTERNATIONAL STANDART</b>	F:180/R160   F:160/R140
<b>CUBOS</b>	Dianteiro/Traseiro   Cassete 8,9,10v.   Free hub International Standard   32 ou 36 furos   Suporte disco: parafuso   Eixo de 9 mm   Blocação
<b>O.L.D.</b>	Dianteiro 100 mm   Traseiro 142 mm
<b>ROTORES</b>	Dianteiro/Traseiro   160 mm   Parafuso (6)   2 mm de espessura
<b>PESO</b>	1.5kg (Aproximado)
<b>EMBALAGEM</b>	10 peças
<b>32F</b>	13207
<b>36F</b>	13208



FOTOS MERAMENTE ILUSTRATIVAS. AS INFORMAÇÕES/CONFIGURAÇÕES DE PRODUTOS PODERÃO SOFRER ALTERAÇÕES SEM AVISO PRÉVIO.

ENTRE EM CONTATO COM O SEU CONSULTOR OU FALE COM O NOSSO TIME DE TELEVENDAS PELO (33) 3277-3030.

## Conjunto de **FREIO A DISCO** hidráulico | Mod01

<b>CARACTERÍSTICA</b>	Material: Alumínio/Aço Peso: 730 gr (Apenas freio   Par)
<b>FREIO DIANTEIRO</b>	Características: X-Time hidráulico   Abraçadeira com dois parafusos   Reservatório de alumínio   Óleo mineral   Caliper 2 pistões   Mangueira com 800 mm Peso: 355 gr
<b>FREIO TRASEIRO</b>	Características: X-Time hidráulico   Abraçadeira com dois parafusos   Reservatório de alumínio   Óleo mineral   Caliper 2 pistões   Mangueira com 1550 mm Peso: 375 gr Observação: O freio traseiro vem desconectado no Manete (sistema j-kit) para instalação em bicicletas com cabeamentos internos. Acompanha olivas, pinos e terminal de acabamento.
<b>EMBALAGEM</b>	20 peças

20510



## Pinça RM2 para **FREIO A DISCO** mecânico

<b>CARACTERÍSTICA</b>	Mecânico   Dianteiro e traseiro   compatível com de discos de 160 mm   Incluso pastilha
<b>MATERIAL</b>	alumínio
<b>EMBALAGEM</b>	50 peças
<b>DIANTEIRO</b>	13199
<b>TRASEIRO</b>	13200

### PASTILHAS COMPATÍVEIS

<b>CÓDIGO</b>	3884 13216
---------------	---------------

FOTOS MERAMENTE ILUSTRATIVAS. AS INFORMAÇÕES/CONFIGURAÇÕES DE PRODUTOS PODERÃO SOFRER ALTERAÇÕES SEM AVISO PRÉVIO.

ENTRE EM CONTATO COM O SEU CONSULTOR OU FALE COM O NOSSO TIME DE TELEVENDAS PELO (33) 3277-3030.

## Pinça Ride para **FREIO A DISCO** mecânico

**CARACTERÍSTICA** Mecânico | Dianteiro e traseiro | compatível com de discos de 160 mm | Incluso pastilha

**MATERIAL** alumínio

**EMBALAGEM** 50 peças

**DIANTEIRO**

13212



**TRASEIRO**

13213



### PASTILHAS COMPATIVÉIS

CÓDIGO	
8063	
13222	



## Rotor para **FREIO A DISCO** 180 mm

**CARACTERÍSTICA** Dianteiro ou traseiro | 180 mm | Fixação por 6 parafusos | 1.9 mm de espessura | conjunto com 6 parafusos allen

**MATERIAL** aço

**PESO** 130 g

**EMBALAGEM** 100 peças

13210



## Rotor para **FREIO A DISCO** 203 mm

**CARACTERÍSTICA** Dianteiro ou traseiro | 203 mm | Fixação por 6 parafusos | 1.9 mm de espessura | conjunto com 6 parafusos allen

**MATERIAL** aço

**PESO** 193 g

**EMBALAGEM** 100 peças

13211

**XTIME**

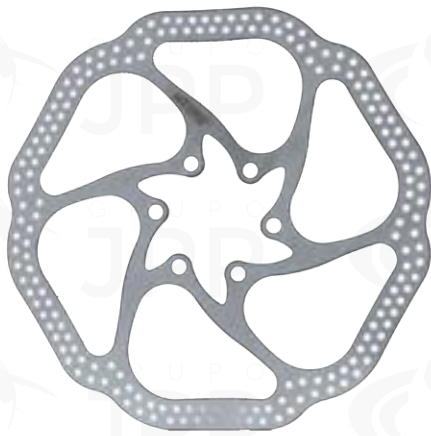

### Rotor para **FREIO A DISCO** 160 mm

**CARACTERÍSTICA** Dianteiro ou traseiro | 160 mm | Fixação por 6 parafusos | 1.9 mm de espessura | conjunto com 6 parafusos allen

**MATERIAL** aço

**PESO** 103 g

**EMBALAGEM** 100 peças

13209

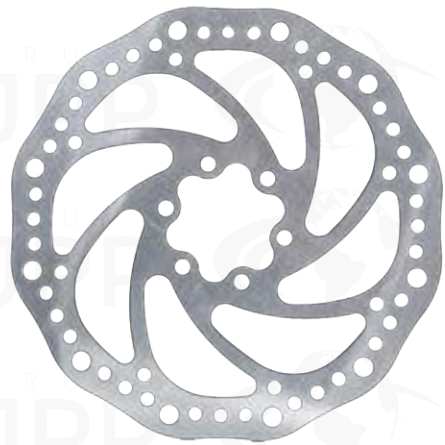

### Rotor para **FREIO A DISCO** Standard 160 mm

**CARACTERÍSTICA** 160 mm | Fixação por 6 parafusos | 2 mm de espessura | conjunto com 6 parafusos allen

**MATERIAL** aço

**PESO** 142 g

**EMBALAGEM** 100 peças

13196 - 160MM. XT-01

23830 - 160MM. XT-02

### Pastilha Mod.01 para **FREIO A DISCO**

**CARACTERÍSTICA** Com mola

**COMPATIBILIDADE** X-time mecânico código: 13197 e 13198

**EMBALAGEM** 20 peças

13267



### Pastilha RM 10 para **FREIO A DISCO**

**CARACTERÍSTICA** Semimetálico | Com mola

**COMPATIBILIDADE** X-Time RM2, SHIMANO HID/MEC (M395/M446) e Tektro

**EMBALAGEM** 10 peças

13216



### Pastilha RD 1 para **FREIO A DISCO**

<b>CARACTERÍSTICA</b>	Dianteiro e traseiro
<b>COMPATIBILIDADE</b>	Para freio TSW Ride até 2016 e Zoom
<b>EMBALAGEM</b>	100 peças

13217



### Pastilha RD 2 para **FREIO A DISCO**

<b>CARACTERÍSTICA</b>	Dianteiro e traseiro
<b>COMPATIBILIDADE</b>	Para pinça de freio Ride
<b>EMBALAGEM</b>	100 peças

13222



### Pastilha RM 52 para **FREIO A DISCO**

<b>CARACTERÍSTICA</b>	Com mola   Semimetálico
<b>COMPATIBILIDADE</b>	SHIMANO XTR (M985) e XT (M785)
<b>EMBALAGEM</b>	10 peças

13219



### Pastilha RM 05 para **FREIO A DISCO**

<b>CARACTERÍSTICA</b>	Semimetálico
<b>COMPATIBILIDADE</b>	Tektro
<b>EMBALAGEM</b>	10 peças

13223



### Pastilha RM 08F para **FREIO A DISCO**

<b>CARACTERÍSTICA</b>	Semimetálico
<b>COMPATIBILIDADE</b>	Zoom
<b>EMBALAGEM</b>	10 peças

13224





### Pastilha RM 09 para **FREIO A DISCO**

**CARACTERÍSTICA** Com mola Semimetálico

**COMPATIBILIDADE** Avid

**EMBALAGEM** 10 peças

13225



### Pastilha RM 14 para **FREIO A DISCO**

**CARACTERÍSTICA** Com mola Semimetálico

**COMPATIBILIDADE** Avid, Promax

**EMBALAGEM** 10 peças

13226



### Pastilha RM 22 para **FREIO A DISCO**

**CARACTERÍSTICA** Com mola Semimetálico

**COMPATIBILIDADE** Formula

**EMBALAGEM** 10 peças

13227



### Pastilha RM 29 para **FREIO A DISCO**

**CARACTERÍSTICA** Semimetálico

**COMPATIBILIDADE** Tektro

**EMBALAGEM** 10 peças

13228



### Pastilha RM 25 para **FREIO A DISCO**

**CARACTERÍSTICA** Semimetálico

**EMBALAGEM** 10 peças

13229



### Pastilha RM 60 para FREIO A DISCO

**CARACTERÍSTICA** Com mola | Semimetálico

**COMPATIBILIDADE** Avid Elixir

**EMBALAGEM** 10 peças

13220



### Pastilha RM 17 para FREIO A DISCO

**CARACTERÍSTICA** Com mola | Semimetálico

**COMPATIBILIDADE** SHIMANO XTR (M965/966) XT (M765) e SAINT

**EMBALAGEM** 10 peças

13218



### Pastilha RM 37 para FREIO A DISCO

**CARACTERÍSTICA** Semimetálico

**COMPATIBILIDADE** Hayes

**EMBALAGEM** 10 peças

13230



### Pastilha RM 64 para FREIO A DISCO

**CARACTERÍSTICA** Dianteiro e traseiro

**COMPATIBILIDADE** Sram®

**EMBALAGEM** 10 peças

13232



XTRIMME



## PASTILHA DE FREIO disco X-Time | XTRM-70

<b>CARACTERÍSTICA</b>	Pastilha de freio X-Time para freio a disco orgânica   Compatível com freios Formula modelos R1, Mega e The One
<b>MATERIAL</b>	Aço
<b>COMPOSIÇÃO</b>	Orgânica
<b>PESO</b>	19 gr
<b>EMBALAGEM</b>	50 peças
	13221



## ROLAMENTO de Cubo X-Time | 6000

<b>CARACTERÍSTICA</b>	Rolamento de esferas 6000-2 rs   Rolamento de esferas de sulco profundo   2 fechos selados   Id (diâmetro interno): 10 mm   Od (diâmetro externo): 26 mm   Largura: 9 mm   Quantidade: 10 rolamentos (pacote)
<b>LUBRIFICAÇÃO</b>	Graxa
<b>DIMENSÕES</b>	10 x 26 x 9 mm
<b>MATERIAL</b>	Aço
<b>PESO</b>	20 gr (unidade)
<b>EMBALAGEM</b>	50 peças
	17026



## ROLAMENTO de Cubo X-Time | 6200

<b>CARACTERÍSTICA</b>	Rolamento de esferas 6200 rs   Rolamento de esferas de sulco profundo   2 fechos selados   Id (diâmetro interno): 10 mm   Od (diâmetro externo): 30 mm   Largura: 9 mm   Quantidade: 10 rolamentos (pacote)
<b>LUBRIFICAÇÃO</b>	Graxa
<b>DIMENSÕES</b>	10 x 30 x 9 mm
<b>MATERIAL</b>	Aço
<b>PESO</b>	30 gr (unidade)
<b>EMBALAGEM</b>	50 peças
	17027

FOTOS MERAMENTE ILUSTRATIVAS. AS INFORMAÇÕES/CONFIGURAÇÕES DE PRODUTOS PODERÃO SOFRER ALTERAÇÕES SEM AVISO PRÉVIO.

ENTRE EM CONTATO COM O SEU CONSULTOR OU FALE COM O NOSSO TIME DE TELEVENDAS PELO (33) 3277-3030.

## ROLAMENTO de Cubo X-Time | 6001

**CARACTERÍSTICA** Rolamento de esferas 6001 rs |  
Rolamento de esferas de sulco profundo  
| 2 fechos selados | Id (diâmetro interno):  
12 mm | Od (diâmetro externo): 28  
mm | Largura: 9 mm | Quantidade: 10  
rolamentos (pacote)

**LUBRIFICAÇÃO** Graxa

**DIMENSÕES** 12 x 28 x 9 mm

**MATERIAL** Aço

**PESO** 22 gr (unidade)

**EMBALAGEM** 50 peças

17028



## Regulador De Macaneta Alum. Fino

**CARACTERÍSTICA**

- Regulador De Maçaneta
- Material Alumínio
- Diâmetro Da Rosca 7mm (M7)
- Passo Da Rosca 1.0mm

**MATERIAL** Alumínio

**PESO** 58gr - Peso Referente Ao Pacote Com 20  
Unidades

**EMBALAGEM** 500 Unidades

23202



X-TIME

## Regulador De Macaneta Alum. Grosso

**CARACTERÍSTICA**

- Regulador De Maçaneta
- Material Alumínio
- Diâmetro Da Rosca 10mm (M10)
- Passo Da Rosca 1.0mm

**MATERIAL** Alumínio

**PESO** 94gr - Peso Referente Ao Pacote Com 20  
Unidades

**EMBALAGEM** 500 Unidades

23201



## Conduíte Preto C/Teflon 4mm P/ Câmbio (Rolo 20 Mts)

<b>CARACTERÍSTICA</b>	<ul style="list-style-type: none"><li>• Conduíte para marcha</li><li>• Material Aço Revestido De Nylon</li><li>• Diâmetro 4mm</li><li>• Fios Paralelo</li><li>• Revestimento Interno De Teflon</li><li>• Ideal Para Marchas</li></ul>
-----------------------	---

**MATERIAL** Aço Revestido De Nylon

**PESO** 664gr - Peso Referente Ao Rolo Com 20 Metros

**EMBALAGEM** 25 Unidades (Rolo)

23194



## Conduíte Preto C/Teflon 5mm P/ Freio Esp. (Rol 20 Mts)

<b>CARACTERÍSTICA</b>	<ul style="list-style-type: none"><li>• Conduíte De Freio</li><li>• Material Aço Revestido De Nylon</li><li>• Diâmetro 5mm</li><li>• Fios Paralelo</li><li>• Revestimento Interno De Teflon</li><li>• Ideal Para Freio À Disco</li></ul>
-----------------------	--

**MATERIAL** Aço Revestido De Nylon

**PESO** 808gr - Peso Referente Ao Rolo Com 20 Metros

**EMBALAGEM** 25 Unidades (Rolo)

23203



## CONECTOR E OLIVA MODELO 02 para freio hidráulico

**CARACTERÍSTICA** Freio a disco hidráulico

**EMBALAGEM** 50

**FATOR.** 25 conjuntos

12335





### Manete V BRAKE

13201

<b>CARACTERÍSTICA</b>	Dianteiro e traseiro
<b>MATERIAL</b>	alumínio
<b>PESO</b>	150 g (par)
<b>EMBALAGEM</b>	100 peças

### Cabo para freio traseiro extra light ceci

<b>CARACTERÍSTICA</b>	19 Fios ceci   Extra light
<b>COMPRIMENTO</b>	180 cm
<b>ESPESSURA</b>	2.5 mm
<b>CONTEÚDO</b>	50 cabos
<b>EMBALAGEM</b>	500 peças

17845



XTIME

### Cabo câmbio tras 19 fios x 1900mm inox (cx 50 peças)

<b>CARACTERÍSTICA</b>	<ul style="list-style-type: none"><li>• Cabo De Câmbio</li><li>• Material Aço Inoxidável</li><li>• 19 Fios</li><li>• Comprimento 1900mm</li><li>• Diâmetro 1.2mm</li></ul>
<b>MATERIAL</b>	Aço Inox
<b>PESO</b>	735gr - Peso Referente A Caixa Com 50 Unidades
<b>CONTEÚDO</b>	50 cabos
<b>EMBALAGEM</b>	20 Unidades (Caixa)

17843



FOTOS MERAMENTE ILUSTRATIVAS. AS INFORMAÇÕES/CONFIGURAÇÕES DE PRODUTOS PODERÃO SOFRER ALTERAÇÕES SEM AVISO PRÉVIO.

ENTRE EM CONTATO COM O SEU CONSULTOR OU FALE COM O NOSSO TIME DE TELEVENDAS PELO (33) 3277-3030.



### Cabo para freio traseiro extra light

<b>CARACTERÍSTICA</b>	19 Fios   Extra light   Inox
<b>COMPRIMENTO</b>	190 cm
<b>ESPESSURA</b>	2.5 mm
<b>CONTEÚDO</b>	20 cabos
<b>EMBALAGEM</b>	500 peças

14160



### Cabo para freio Dianteiro extra light

<b>CARACTERÍSTICA</b>	19 Fios   Extra light   Dianteiro
<b>EMBALAGEM</b>	500 peças

14141



### Cabo para freio traseiro extra light

<b>CARACTERÍSTICA</b>	19 Fios   Extra light   Traseiro
<b>EMBALAGEM</b>	500 peças

14142



### Terminal de conduíte

<b>CARACTERÍSTICA</b>	Aço cromado
<b>ESPESSURA</b>	5 mm
<b>CONTEÚDO</b>	100 terminais
<b>EMBALAGEM</b>	500 peças

14163



### Terminal de conduíte

<b>CARACTERÍSTICA</b>	Nylon
<b>ESPESSURA</b>	4 mm
<b>CONTEÚDO</b>	100 terminais
<b>EMBALAGEM</b>	500 peças

14159



### Cabo Câmbio Traseiro

CARACTERÍSTICA	19 Fios
COMPRIMENTO	190 cm
ESPESSURA	2.2 mm
CONTEÚDO	50 cabos
EMBALAGEM	500 peças
	17844



### Terminal de cabo

CARACTERÍSTICA	Alumínio
CONTEÚDO	100 terminais
EMBALAGEM	500 peças
	14162



### Kit de Montagem XT-22

GUIDÃO	X-Time   Rise bar   720 x 31.8 mm   9° backsweep   Rise 20 mm   Alumínio
SUPORTE DE GUIDÃO	X-Time   Ahead set   90 x 31.8 mm / 7°   Alumínio
CANOTE	X-Time   27.2 x 350 mm   Parafuso único   Alumínio
ABRAÇADEIRA	X-Time   Blocagem   31.8 mm   Alumínio
EMBALAGEM	20 peças

15458



### Kit de Montagem XT-23

GUIDÃO	X-Time   Rise bar   720 x 31.8 mm   9° backsweep   Rise 20 mm   Alumínio
SUPORTE DE GUIDÃO	X-Time   Ahead set   90 x 31.8 mm / 7°   Alumínio
CANOTE	X-Time   31.6 x 350 mm   Parafuso único   Alumínio
ABRAÇADEIRA	X-Time   Blocagem   34.9 mm   Alumínio
EMBALAGEM	20 peças

15459



XTIME





## Kit de Montagem **XT-25**

GUIDÃO	X-Time   Reto   720 x 31.8 mm   9° backsweep   Alumínio
SUORTE DE GUIDÃO	X-Time   Ahead set   90 x 31.8 mm / 7°   Alumínio
CANOTE	X-Time   31.6 x 350 mm   Parafuso único   Alumínio
ABRACADEIRA	X-Time   Blocagem   34.9 mm   Alumínio
EMBALAGEM	20 peças

15461



## Kit de Montagem **XT-26**

GUIDÃO	X-Time   Rise bar   720 x 31.8 mm   9° backsweep   Rise 20 mm   Alumínio
SUORTE DE GUIDÃO	X-Time   Ahead set   70 x 31.8 mm / 7°   Alumínio
CANOTE	X-Time   27.2 x 350 mm   Parafuso único   Alumínio
ABRACADEIRA	X-Time   Blocagem   31.8 mm   Alumínio
PESO	830gr
EMBALAGEM	20 peças

19532



## Kit de Montagem **XT-28**

**GUIDÃO** X-Time | Reto | 720 x 31.8 mm | 9° backsweep | Alumínio

**SUPORTE DE GUIDÃO** X-Time | Ahead set | 70 x 31.8 mm / 7° | Alumínio

**CANOTE** X-Time | 27.2 x 350 mm | Parafuso único | Alumínio

**ABRACADEIRA** X-Time | Blocação | 31.8 mm | Alumínio

**PESO** 834gr

**EMBALAGEM** 20 peças

19537



## Kit de Montagem **XT-24**

**GUIDÃO** X-Time | Reto | 720 x 31.8 mm | 9° backsweep | Alumínio

**SUPORTE DE GUIDÃO** X-Time | Ahead set | 90 x 31.8 mm / 7° | Alumínio

**CANOTE** X-Time | 27.2 x 350 mm | Parafuso único | Alumínio

**ABRACADEIRA** X-Time | Blocação | 31.8 mm | Alumínio

**EMBALAGEM** 20 peças

15460

FOTOS MERAMENTE ILUSTRATIVAS. AS INFORMAÇÕES/CONFIGURAÇÕES DE PRODUTOS PODERÃO SOFRER ALTERAÇÕES SEM AVISO PRÉVIO.

ENTRE EM CONTATO COM O SEU CONSULTOR OU FALE COM O NOSSO TIME DE TELEVENDAS PELO (33) 3277-3030.

**X-TIME**



### Guidão Alum MTB 31.8mm **RETO** pt x-TIME

<b>MATERIAL</b>	Alumínio
<b>TAMANHO</b>	31.8mm x720 mm
<b>RISE</b>	0°
<b>UPSWEEP</b>	0
<b>BACKSWEEP</b>	9°
<b>PESO APROXIMANDO</b>	312 g
<b>EMBALAGEM</b>	15 unidades

22702



### Guidão X-Time **RETO**

<b>MATERIAL</b>	Alumínio
<b>TAMANHO</b>	720mmx31.8mm
<b>EMBALAGEM</b>	50 peças

12901



### Guidão X-Time **RETO**

<b>MATERIAL</b>	Alumínio
<b>TAMANHO</b>	730 x 31.8 mm
<b>BACKSWEEP</b>	9°
<b>UPSWEEP</b>	0
<b>PESO APROXIMANDO</b>	314 g
<b>EMBALAGEM</b>	50 peças

15430

FOTOS MERAMENTE ILUSTRATIVAS. AS INFORMAÇÕES/CONFIGURAÇÕES DE PRODUTOS PODERÃO SOFRER ALTERAÇÕES SEM AVISO PRÉVIO.

ENTRE EM CONTATO COM O SEU CONSULTOR OU FALE COM O NOSSO TIME DE TELEVENDAS PELO (33) 3277-3030.



### Guidão ALUMÍNIO MTB 31.8 MM X 740 MM RETO PT XT

**CARACTERÍSTICA**

- Guidão reto de alumínio
- Rise 0°
- Upsweep 0°
- Backsweep 9°

**MATERIAL** Alumínio

**TAMANHO** 740 x 31.8mm

**PESO APROXIMANDO** 296g

**EMBALAGEM** 15 peças

23850



### Guidão X-Time RISE BAR

**MATERIAL** Alumínio

**TAMANHO** 730 x 31.8 mm

**BACKSWEEP** 9°

**UPSWEEP** 9°

**RISE** 20 mm

**PESO APROXIMANDO** 319 g

**EMBALAGEM** 50 peças

15429



### Guidão X-Time **RISE BAR - 680 MM**

MATERIAL	Aço
TAMANHO	680 x 25.4 mm
BACKSWEEP	9°
RISE	40 mm
PESO APROXIMANDO	445g
EMBALAGEM	50 peças

18054 OU 17869



### Guidão **ALUM. SPEED 420/440 MM** **31.8MM PT XT**

CARACTERÍSTICA	<ul style="list-style-type: none"><li>• Guidão de alumínio</li><li>• Anatômico</li></ul>
MATERIAL	Alumínio
TAMANHO	420/440 mm x 31.8 mm
PESO APROXIMANDO	428g (guidão de 420mm)
EMBALAGEM	15 peças
420MM	23853
440MM	23854



FOTOS MERAMENTE ILUSTRATIVAS. AS INFORMAÇÕES/CONFIGURAÇÕES DE PRODUTOS PODERÃO SOFRER ALTERAÇÕES SEM AVISO PRÉVIO.

ENTRE EM CONTATO COM O SEU CONSULTOR OU FALE COM O NOSSO TIME DE TELEVENDAS PELO (33) 3277-3030.

## Suporte de guidão alum. Mtb ahead 17° pt xt

<b>CARACTERÍSTICA</b>	<ul style="list-style-type: none"><li>• Over Ahead Set</li><li>• Compatível com 31.8 mm</li></ul>
<b>MATERIAL</b>	Alumínio
<b>TAMANHO</b>	70 mm / 80 mm
<b>ÂNGULO</b>	+/- 17°
<b>PESO</b>	130g
<b>EMBALAGEM</b>	20 peças
<b>CÓDIGO:</b>	22752 - 80MM/ 17º 22753 - 70MM/ 17º



## Suporte de Guidão X-Time

<b>CARACTERÍSTICA</b>	Ahead Set
<b>MATERIAL</b>	Alumínio
<b>TAMANHO</b>	90 x 31.8 mm / 7°
<b>PESO APROXIMADO</b>	179 g
<b>EMBALAGEM</b>	50 peças
	15431



## Suporte de Guidão X-Time

<b>CARACTERÍSTICA</b>	Ahead Set
<b>MATERIAL</b>	Alumínio
<b>TAMANHO</b>	60 x 31.8 mm / 7°
<b>PESO APROXIMADO</b>	155gr
<b>EMBALAGEM</b>	50 peças
	19524

X-TIME

## Suporte de Guidão Alum. MTB AHEAD 80 MM 17° PT X-Time



**CARACTERÍSTICA**

- Over Ahead Set
- Compatível com 31.8 mm
- Suporte de Alumínio

**MATERIAL** Alumínio

**TAMANHO** 70 mm | 80 mm | 90 mm  
100 mm / +- 17°

**PESO APROXIMADO** 127gr (referente ao suporte 80 mm)

**EMBALAGEM** 20 peças

**CÓDIGO:** 23860 - 80MM/ 17°  
23861 - 70 MM/ 17°  
23862 - 90 MM/ 17°  
23863 - 100 MM/ 17°

X-TIME

## Suporte de Guidão Alum. MTB AHEAD 80 MM 7° PT X-Time



**CARACTERÍSTICA**

- SUPORTE DE GUIDÃO ALUMÍNIO
- OVER AHEAD SET
- TAMANHOS DISPONÍVEIS 60MM/ 80MM/ 90MM E 100MM
- ÂNGULO +-7°
- COMPATÍVEL COM GUIDÃO 31.8MM

**MATERIAL** Alumínio

**TAMANHO** 60 mm | 80 mm | 90 mm | 100 mm / +- 7°

**PESO APROXIMADO** 158gr (referente ao suporte 80 mm)

**EMBALAGEM** 20 peças

**CÓDIGO:** 23855 - 80MM/ 7°  
23856 - 60 MM/ 7°  
23858 - 90 MM/ 7°  
23859 - 100 MM/ 7°





### Suporte de Guidão X-Time

CARACTERÍSTICA	Ahead Set
MATERIAL	Alumínio
TAMANHO	80 x 31.8 mm / 7°
PESO APROXIMADO	174gr
EMBALAGEM	50 peças
	19520



### Suporte de Guidão X-Time

CARACTERÍSTICA	Ahead Set
MATERIAL	Alumínio
TAMANHO	70 x 31.8 mm / 7°
PESO APROXIMADO	167gr
EMBALAGEM	50 peças
	19522



### Canote SELIM ALUMÍNIO 31.6 X 400MM SLIM PT XT

CARACTERÍSTICA	<ul style="list-style-type: none"><li>• Canote de alumínio</li><li>• Micro ajuste</li><li>• Limite inserção 130mm</li></ul>
MATERIAL	Alumínio
TAMANHO	400 x 31.6mm
PESO APROXIMANDO	300g
EMBALAGEM	25 peças

23867





### Canote **SELIM ALUMÍNIO** **27.2 X 400MM SLIM PT XT**

**CARACTERÍSTICA** • Canote de alumínio  
• Micro ajuste  
• Limite inserção 130mm

**MATERIAL** Alumínio

**TAMANHO** 400 x 27.2mm

**PESO APROXIMANDO** 300g

**EMBALAGEM** 25 peças

23869

**XTIME**

### Canote de selim **X-Time**

**CARACTERÍSTICA** Parafuso único

**MATERIAL** Alumínio

**TAMANHO** 27.2 x 350 mm | 31.6 x 350 mm

**PESO APROXIMANDO** 281 g

**EMBALAGEM** 50 peças

**27.2 MM** 15432

**31.6 MM** 15433





### Canote selim alum. 31.6 X 350mm **SLIM PT XT**

<b>CARACTERÍSTICA</b>	Micro ajuste Limite inserção 100mm
<b>MATERIAL</b>	Alumínio
<b>TAMANHO</b>	350 mm x 31.6 mm
<b>PESO APROXIMANDO</b>	270 g
<b>EMBALAGEM</b>	25 peças
<b>CÓDIGO</b>	22758



### Abraçadeira **X-Time**

<b>CARACTERÍSTICA</b>	Com Blocaagem
<b>MATERIAL</b>	Alumínio
<b>TAMANHO</b>	31.8 mm   34.9 mm
<b>PESO APROXIMANDO</b>	51 g
<b>EMBALAGEM</b>	200 peças
<b>31.8 MM</b>	15434
<b>34.9 MM</b>	15435

**X-TIME**

### Abraçadeira **SELIM ALUM. MTB 31.8 C/ BLOCAAGEM PT XT**

<b>CARACTERÍSTICA</b>	<ul style="list-style-type: none"> <li>• Abraçadeira de aperto do canote</li> <li>• Ajuste por blocaagem</li> </ul>
<b>MATERIAL</b>	Alumínio
<b>TAMANHO</b>	31.8MM
<b>PESO APROXIMANDO</b>	43 g
<b>EMBALAGEM</b>	200 peças
<b>31.8 MM</b>	23872



FOTOS MERAMENTE ILUSTRATIVAS. AS INFORMAÇÕES/CONFIGURAÇÕES DE PRODUTOS PODERÃO SOFRER ALTERAÇÕES SEM AVISO PRÉVIO.

ENTRE EM CONTATO COM O SEU CONSULTOR OU FALE COM O NOSSO TIME DE TELEVENDAS PELO (33) 3277-3030.



## Abraçadeira **SELIM ALUM. MTB 31.8 PT XT**

<b>CARACTERÍSTICA</b>	<ul style="list-style-type: none"> <li>• Abraçadeira de aperto do canote</li> <li>• Ajuste por parafuso</li> </ul>
<b>MATERIAL</b>	Alumínio
<b>TAMANHO</b>	31.8MM
<b>PESO APROXIMANDO</b>	22 g
<b>EMBALAGEM</b>	200 peças
<b>31.8 MM</b>	23874

## Porta Ferramentas **X-Time Save Tools**

<b>CARACTERÍSTICA</b>	Ideal para transportar Camara de ar, ferramentas, chaves e suplementos
<b>MATERIAL</b>	Plástico
<b>TAMANHO</b>	ø 7,5 cm   Altura: 13,5 cm
<b>EMBALAGEM</b>	01 peça

14706



## Kit Conduíte e Cabo para Trava **Remote – IMPORTADO**



<b>Característica</b>	KIT conduíte   Conduíte 4mm teflonado paralelo   Terminais de alumínio na cor preta   Regulador de tensão   Cabo de marcha
<b>Composição</b>	1 conduíte   1 cabo de aço   4 terminais de conduíte   1 regulador
<b>Dimensões</b>	Cabo de aço 1900 mm X 1.2 mm   Conduíte 1250 mm X 4 mm
<b>Embalagem</b>	10 pares

22701



### Conduite para câmbio

CARACTERÍSTICA	Para câmbio   Com teflon
COMPRIMENTO	30 m
ESPESSURA	4 mm
EMBALAGEM	25 peças
	14145



### Sapata Freio Pino – IMPORTADO

Característica	Para freio V. Brake   70mm
Material	Nylon
Embalagem	250 pares
	◆ 07467



### Sapata Freio Orbital Alen – IMPORTADO

Característica	Para freio V. Brake   70mm
Material	Nylon
Embalagem	250 pares
	◆ 07466

XTIME



### Espaçador de mov. de direção 5mm/ 8mm **Liso preto**

<b>MATERIAL</b>	Alumínio
<b>CARACTERÍSTICA</b>	Espaçador de direção liso Diâmetro interno 29mm Compatível com espiga ahead set 28.6mm

**PESO** 3g - 5mm | 5g - 8mm

**EMBALAGEM** 100 peças

**5 MM** 22776

**8 MM** 22777



### Espaçador de mov. de direção 10 mm **Liso preto**

<b>MATERIAL</b>	Alumínio
<b>CARACTERÍSTICA</b>	Espaçador de direção liso Diâmetro interno 29mm Compatível com espiga ahead set 28.6mm

**PESO** 8 g

**EMBALAGEM** 100 peças

**10 MM** 22778

**10 MM** 22778

**X-TIME**



### Espaçador de movimento de direção **Liso**

<b>MATERIAL</b>	Alumínio
<b>EMBALAGEM</b>	100 peças
<b>8 MM</b>	13097
<b>10 MM</b>	13098
<b>15 MM</b>	13099



### Espaçador **Movimento de direção**

<b>CARACTERÍSTICA</b>	Ahead set 1-1/8"
<b>TAMANHO</b>	5 mm
<b>MATERIAL</b>	Carbono
<b>PESO</b>	1,5 g
<b>EMB.</b>	20 peças
<b>FATOR</b>	5

13182





### **Espaçador Movimento de direção**

<b>CARACTERÍSTICA</b>	Ahead set 1-1/8"
<b>TAMANHO</b>	8 mm
<b>MATERIAL</b>	Carbono
<b>PESO</b>	3 g
<b>EMB.</b>	20 peças
<b>FATOR</b>	5

13183



### **Tampa movimento de direção ahead**

<b>CARACTERÍSTICA</b>	Com aranha e parafuso MTB
<b>EMBALAGEM</b>	50 peças
	13096
	13095



### **Extensor tubo do garfo**

<b>CARACTERÍSTICA</b>	Headset   28.6 mm   4 espaçadores
<b>MATERIAL</b>	Alumínio
<b>EMBALAGEM</b>	1 peças

13119



### **Movimento de direção Tapered / Mega Over**

<b>CARACTERÍSTICA</b>	Ahead Set   Tapered Integrada/Semi integrada   Mega Over Semi integrada/ Externa (com adaptador para 30 mm)
<b>INTEGRADA</b>	Tapered 1-1/8" (IS41/28.6) / 1.5" (IS52/40)
<b>SEMI INTEGRADA</b>	Tapered 1-1/8" (ZS44/28.6) / 1.5" (ZS56/40)
<b>MEGA OVER</b>	1-1/8"   copo superior semi integrado (ZS44/28.6) e copo inferior externo (EC44/30*) usando o adaptador para 30 mm
<b>EMBALAGEM</b>	20 peças

13114



### Movimento de direção **over ahead bmx**

<b>CARACTERÍSTICA</b>	Ahead Set Over   p/ Rotor
<b>EXTENSÃO</b>	1.1/8
<b>MATERIAL</b>	Aço
<b>EMBALAGEM</b>	100 peças

13108



### Movimento de direção **super over ahead**

<b>CARACTERÍSTICA</b>	Ahead Set Tapered   Direção 1 1/8x44mm   Integrado (com caixas)
<b>MODELO</b>	Com adaptador para garfo 30mm e 39.8mm
<b>EXTENSÃO</b>	1.5x1.1/8
<b>EMBALAGEM</b>	100 peças

13112



### Movimento de direção **super over tapered**

<b>CARACTERÍSTICA</b>	Ahead Set Tapered   Direção 1 1/8x1.5   Integrado (s/ caixas)
<b>MODELO</b>	Com adaptador para garfo 30mm e 39.8mm
<b>ROLAMENTOS</b>	Menor: diâmetro externo: 41 mm, diâmetro interno: 31 mm, Espessura: 6,5 mm Maior: diâmetro externo: 52 mm, diâmetro interno: 39,9 mm, Espessura: 8 mm
<b>EMBALAGEM</b>	100 peças

13113



### Aranha para **garfo de carbono**

<b>CARACTERÍSTICA</b>	Para garfo com a espiga em carbono   Tipo expander
<b>MEDIDA DA ESPIGA</b>	25.4mm (medida interna do Garfo)
<b>MODALIDADE</b>	Garfos MTB / Speed
<b>MATERIAL</b>	Aço/Alumínio
<b>PESO APROXIMADO</b>	42 g
<b>EMBALAGEM</b>	10 peças

22699

FOTOS MERAMENTE ILUSTRATIVAS. AS INFORMAÇÕES/CONFIGURAÇÕES DE PRODUTOS PODERÃO SOFRER ALTERAÇÕES SEM AVISO PRÉVIO.

ENTRE EM CONTATO COM O SEU CONSULTOR OU FALE COM O NOSSO TIME DE TELEVENDAS PELO (33) 3277-3030.

## Movimento de direção mega over ahead

**CARACTERÍSTICA** Ahead mega over | Semi-selado | Esferado

**EXTENSÃO** 1.1/8

**MATERIAL** alumínio/aço

**EMBALAGEM** 100 peças

13115



## Movimento de direção over

**CARACTERÍSTICA** Over | Com rosca

**MODELO** p/ Garfo 25.4mm

**EXTENSÃO** Rosca Colar 1 - 1/8

**EMBALAGEM** 100 peças

13116



## Movimento de Direção SPACE

**CARACTERÍSTICA** Ahead set mega over

**MODELO** Rolamentado

**EXTENSÃO** 1.1/8

**EMBALAGEM** 100 peças

13117



**XTIME**





FOTO ILUSTRATIVA DA EMBALAGEM



## Válvula Tubeless

**CARACTERÍSTICA** Padrão de rosca universal, seguindo as regras de produtos UCI | Núcleo removível Porca recartilhada (alumínio) | válvula Fina (Presta)



**MATERIAL** Alumínio anodizado tipo 6351

**TAMANHO** 45 mm

**PESO** 12 g

**EMBALAGEM** 1 peça

### CORES

-  12902
-  12903
-  12904
-  12905
-  12906
-  12907
-  12908



### Acionador Remoto para Suspensão | Modelo 01

<b>CARACTERÍSTICA</b>	Acionador remoto para trava da suspensão
<b>MATERIAL</b>	Alumínio
<b>PESO</b>	61 g
<b>EMBALAGEM</b>	1 peça
	14875



### Acionador Remoto para Suspensão | Modelo 02

<b>CARACTERÍSTICA</b>	Acionador remoto para trava da suspensão   Abraçadeira articulada   Regulador de tensão do cabo   Acompanha cabo
<b>MATERIAL</b>	Alumínio
<b>PESO</b>	59 g
<b>EMBALAGEM</b>	50 peças
	14876



1



2

### Tampa para Válvula

<b>CARACTERÍSTICA</b>	Compatível com válvula americana   Comprimento 32 mm   Diâmetro 10 mm
<b>MATERIAL</b>	Alumínio
<b>PESO</b>	5 gr
<b>EMBALAGEM</b>	20 peças



3



4

<b>CORES</b>	
	14147
	14149
	14150
	14151

FOTOS MERAMENTE ILUSTRATIVAS. AS INFORMAÇÕES/CONFIGURAÇÕES DE PRODUTOS PODERÃO SOFRER ALTERAÇÕES SEM AVISO PRÉVIO.

ENTRE EM CONTATO COM O SEU CONSULTOR OU FALE COM O NOSSO TIME DE TELEVENDAS PELO (33) 3277-3030.





1 2 3 4 5

## Tampa para Válvula

<b>CARACTERÍSTICA</b>	Pequena (18 mm)
<b>VÁLVULA</b>	Schader (americana)
<b>MATERIAL</b>	Alumínio
<b>CONTEÚDO</b>	20 tampas
<b>EMBALAGEM</b>	500 peças

### CORES

	14154
	14155
	14156
	14157
	14158



## Tampa De Válvula Alum. Vermelha

### CARACTERÍSTICA

- Tampa Para Válvula
- Material Alumínio
- Compatível Com Válvula Americana
- Diâmetro 10mm
- Comprimento 32mm

### PESO

88gr - Peso Referente Ao Pacote Com 20 Unidades

### MATERIAL

Alumínio

### CONTEÚDO

20 tampas

### EMBALAGEM

500 peças

14148



## Núcleo Válvulas Tubeless

### CARACTERÍSTICA

Reparos de válvulas tubeless X-Time | Com tampa | Usinadas torno CNC em metal do tipo latão | Banho protetivo de níquel cromado | Vedações interna de borracha e silicone | Padrão de rosca universal e compatível com todos modelos já existentes no mercado | Seguindo as regras de produtos UCI



### COMPOSIÇÃO

Latão banhado a níquel, vedação de borracha e silicone

### FATOR

5

### COMPATIBILIDADE

Válvulas Presta

### EMBALAGEM

50 peças

12932



## Adaptador para válvula

### CARACTERÍSTICA

Adapta presta para Schader (americana)

### CONTEÚDO

20 adaptadores

### EMBALAGEM

500 peças

14164



## Adaptador Válvula Presta P/ Válvula Americana

### CARACTERÍSTICA

- Adaptador Para Válvula
- Material Bronze
- Adapta Válvula Presta Para Válvula Schader (Americana)
- Diâmetro 10x8mm
- Comprimento 15mm

### PESO

62gr - Peso Referente Ao Pacote Com 20 Unidades

### MATERIAL

Bronze

### CONTEÚDO

20 unidades

### EMBALAGEM

500 peças

23204

FOTOS MERAMENTE ILUSTRATIVAS. AS INFORMAÇÕES/CONFIGURAÇÕES DE PRODUTOS PODERÃO SOFRER ALTERAÇÕES SEM AVISO PRÉVIO.

ENTRE EM CONTATO COM O SEU CONSULTOR OU FALE COM O NOSSO TIME DE TELEVENIDAS PELO (33) 3277-3030.

## Fita ARO TUBELESS 55mt



<b>CARACTERÍSTICA</b>	Fita polipropileno para vedação de aro tubeless
<b>AROS</b>	MTB, MTB Boost e Speed
<b>MATERIAL</b>	Polipropileno
<b>EMBALAGEM</b>	50 peças



**TAMANHO** 55mt x30mm

**APLICAÇÃO.** MTB Boost

**PESO (APROXIMADO)** 167g

12631

**TAMANHO** 55mt x24mm

**APLICAÇÃO.** MTB

**PESO (APROXIMADO)** 125g

12630

**TAMANHO** 55mt x18mm

**APLICAÇÃO.** Speed

**PESO (APROXIMADO)** 100g

12627

## Fita ARO TUBELESS 10mt



<b>CARACTERÍSTICA</b>	Fita polipropileno para vedação de aro tubeless
<b>AROS</b>	MTB, MTB Boost e Speed
<b>MATERIAL</b>	Polipropileno
<b>EMBALAGEM</b>	50 peças



**TAMANHO** 10mt x18mm

**APLICAÇÃO.** Speed

12623

**TAMANHO** 10mt x24mm

**APLICAÇÃO.** MTB

08885

**TAMANHO** 10mt x30mm

**APLICAÇÃO.** MTB Boost

12624



## Ferramenta de Reparo Tubeless

**CARACTERÍSTICA** Ferramenta de inserção 10 unidades de reparo

**EMBALAGEM** 50 peças

12632



## Kit Macarrão Reparo Tubeless

<b>CARACTERÍSTICA</b>	Fabricado em borracha natural pré-vulcanizada e algodão   Pacote com 20 unidades
<b>APLICAÇÃO</b>	Aplicação para vedação de furos maiores que 4 mm em pneus tubeless
<b>FUNCIONAMENTO</b>	O macarrão de reparo funciona juntamente com o selante, em uma reação química entre os dois, fazendo a vedação emergencial
<b>COMPATIBILIDADE</b>	Compatível com selantes à base de látex
<b>EMBALAGEM</b>	50 peças

12909



## Bomba de AR Pequena | Oficina

<b>CARACTERÍSTICA</b>	Apoio para pé dobrável   Cabo Nylon
<b>COMPRIMENTO DA MANGUEIRA</b>	38 cm
<b>COMPATIBILIDADE DE VÁLVULAS</b>	Presta / Schrader (Americana)
<b>PESO APROXIMADO</b>	198g
<b>EMBALAGEM</b>	1 peça

15581



## Bomba de AR grande | Oficina

<b>CARACTERÍSTICA</b>	Apoio para pé dobrável   Cabo Nylon
<b>COMPRIMENTO DA MANGUEIRA</b>	65 cm
<b>COMPATIBILIDADE DE VÁLVULAS</b>	Presta / Schrader (Americana)
<b>PESO APROXIMADO</b>	290g
<b>EMBALAGEM</b>	1 peça

15582



## Bomba de AR | Oficina

<b>CARACTERÍSTICA</b>	Apoio para pé dobrável   Cabo Nylon
<b>COMPRIMENTO DA MANGUEIRA</b>	60 cm
<b>COMPATIBILIDADE DE VÁLVULAS</b>	Schrader (Americana)
<b>PESO APROXIMADO</b>	462g
<b>EMBALAGEM</b>	1 peça

15583

FOTOS MERAMENTE ILUSTRATIVAS. AS INFORMAÇÕES/CONFIGURAÇÕES DE PRODUTOS PODERÃO SOFRER ALTERAÇÕES SEM AVISO PRÉVIO.

ENTRE EM CONTATO COM O SEU CONSULTOR OU FALE COM O NOSSO TIME DE TELEVENDAS PELO (33) 3277-3030.



## Lubrificantes, higiene e limpeza

Soluções abrangentes em termos de manutenção de bicicletas e acessórios.

Com uma linha de lubrificantes e produtos de higiene e limpeza, desenvolvidos com as técnicas mais avançadas e com os insumos mais nobres, revolucionamos os parâmetros de cuidados para bikes, componentes, roupas e demais itens.



FOTOS MERAMENTE ILUSTRATIVAS.



FOTOS MERAMENTE ILUSTRATIVAS. AS INFORMAÇÕES/CONFIGURAÇÕES DE PRODUTOS PODERÃO SOFRER ALTERAÇÕES SEM AVISO PRÉVIO.

ENTRE EM CONTATO COM O SEU CONSULTOR OU FALE COM O NOSSO TIME DE TELEVENDAS PELO (33) 3277-3030.

X-TIME



### Selante para pneus **ULTRA**

**CARACTERÍSTICA** selante para vedação de pneus de bicicletas, agindo de forma eficaz em furos de até 4mm

**CAPACIDADE** 500ml

**EMBALAGEM** 6 peças

08884



### Selante para pneus **ULTRA**

**CARACTERÍSTICA** selante para vedação de pneus de bicicletas, agindo de forma eficaz em furos de até 4mm

**CAPACIDADE** 250ml

**EMBALAGEM** 6 peças

08883

X-TIME



### Cera Lubrificante 120 ml

**CARACTERÍSTICA** Biodegradável, prolonga a vida útil da corrente e diminui a sujeira acumulada

**APLICAÇÃO** Desenvolvida para bicicletas de todas as categorias

**COMPOSIÇÃO** Mistura de ceras naturais, aditivos em baixo percentual (oleígenos, hidrocarbonetos e polissiloxanos), conservante e essência

**EMBALAGEM** 140 peças (120 ml)

12783



### Cera Lubrificante 300 ml

**CARACTERÍSTICA** Biodegradável, prolonga a vida útil da corrente e diminui a sujeira acumulada

**APLICAÇÃO** Desenvolvida para bicicletas de todas as categorias

**COMPOSIÇÃO** Mistura de ceras naturais, aditivos em baixo percentual (oleígenos, hidrocarbonetos e polissiloxanos), conservante e essência

**EMBALAGEM** 12 peças

16167

FOTOS MERAMENTE ILUSTRATIVAS. AS INFORMAÇÕES/CONFIGURAÇÕES DE PRODUTOS PODERÃO SOFRER ALTERAÇÕES SEM AVISO PRÉVIO.

ENTRE EM CONTATO COM O SEU CONSULTOR OU FALE COM O NOSSO TIME DE TELEVENDAS PELO (33) 3277-3030.

## Suporte Caramanhola – SHUNFENG

Característica 2 Parafusos | Alumínio

Embalagem 100 peças

◆ 00928

◆ 04480

ANODIZADO

◆ 04844

◆ 04845



## Cesta Vime Retrô Com Tampa MITSU

Característica Cesta para bicicleta, com estilo vintage retrô com tampa;  
-Acompanha suporte de nylon para fixação no guidão da bicicleta;  
-Removível

Tamanho Topo: 33 x 26 x 23cm  
Base: 25 x 20 cm (com suporte)

Embalagem 12 peças

11713



## Cesta Vime Retrô MITSU

Característica Cesta para bicicleta, com estilo vintage retrô;  
-Acompanha suporte de nylon para fixação no guidão da bicicleta;  
-Removível

Tamanho Topo: 36 x 28 x 23/26cm  
Base: 26 x 20.3 cm (com suporte)

Embalagem 8 peças

11714



FOTOS MERAMENTE ILUSTRATIVAS. AS INFORMAÇÕES/CONFIGURAÇÕES DE PRODUTOS PODERÃO SOFRER ALTERAÇÕES SEM AVISO PRÉVIO.

ENTRE EM CONTATO COM O SEU CONSULTOR OU FALE COM O NOSSO TIME DE TELEVENDAS PELO (33) 3277-3030.



---

C A T Á L O G O

# ***ARISUN***

---

P N E U S

**ARISUN**  
T I R E S



## PNEU ARISUN MOUNT BONA

*MOUNTAIN BIKE*

TAMANHO	TPI	TIPO	CODIGO
29X2.10	27	SKINWALL	08655
29X2.10	120	KEVLAR TUBELESS	-
29X2.35	27	SKINWALL	24099
29X2.35	60	KEVLAR	07796
29X2.35	120	KEVLAR TUBELESS	09327

**ARISUN**



## PNEU ARISUN MOUNT GRAHAM

*MOUNTAIN BIKE*

TAMANHO	TPI	TIPO	CODIGO
29X2.20	27	SKINWALL	08654
29X2.20	60	KEVLAR	06742
29X2.20	120	KEVLAR TUBELESS	10180



## MOUNT EMMONS - ARISUN

*MOUNTAIN BIKE*

TAMANHO	TPI	TIPO	CODIGO
29 X 2.10	30	BANDA LEVE	06748

FOTOS MERAMENTE ILUSTRATIVAS. AS INFORMAÇÕES/CONFIGURAÇÕES DE PRODUTOS PODERÃO SOFRER ALTERAÇÕES SEM AVISO PRÉVIO.

ENTRE EM CONTATO COM O SEU CONSULTOR OU FALE COM O NOSSO TIME DE TELEVENDAS PELO (33) 3277-3030.

## PNEU ARISUN MOUNT GRAHAM TANWALL



### CROSS COUNTRY

**CARACTERÍSTICA** Aro 29", Faixa Marrom / Logomarca Preta Small Block., Medida 29 x 2.20 (55 x 622) Skinwall e Kevlar

**MATERIAL** Borracha

**PESO** Skinwall 790 gr  
Kevlar 740 gr

**EMBALAGEM** Skinwall 25 peças  
Kevlar 10 peças

TAMANHO	TPI	TIPO	CODIGO
29 X 2.20	27	SKINWALL	21814

TAMANHO	TPI	TIPO	CODIGO
29 X 2.20	60	KEVLAR	24094
29 X 2.20	27	SKINWALL	24095



## MOUNT COOK - ARISUN

### MOUNTAIN BIKE

TAMANHO	TPI	TIPO	CODIGO
29X2.25	60	KEVLAR	07785

## MOUNT COOK TANWALL - ARISUN

### CROSS COUNTRY

**CARACTERÍSTICA** Tecnologia Nylon Defense (ND)

**MATERIAL** Borracha

**PESO** 818 gr

**EMBALAGEM** 25 peças



TAMANHO	TPI	TIPO	CODIGO
29 X 2.25	60	KEVLAR	24101

FOTOS MERAMENTE ILUSTRATIVAS. AS INFORMAÇÕES/CONFIGURAÇÕES DE PRODUTOS PODERÃO SOFRER ALTERAÇÕES SEM AVISO PRÉVIO.

ENTRE EM CONTATO COM O SEU CONSULTOR OU FALE COM O NOSSO TIME DE TELEVENDAS PELO (33) 3277-3030.

ARISUN



## RAPIDE - ARISUN

ROAD BIKE

TAMANHO	TPI	TIPO	CODIGO
700X32C	60	KEVLAR	14266
700X28C	60	KEVLAR	14265
700X25C	60	KEVLAR	06757
700X23C	30	BANDA LEVE	-



## VITESSE - ARISUN

ROAD BIKE

TAMANHO	TPI	TIPO	CODIGO
700X25C	27	SKINWALL	08656



## CUTTING EDGE - ARISUN

BMX

TAMANHO	TPI	TIPO	CODIGO
20X2.10	27	SKINWALL	20518

**CARACTERÍSTICA** Pneu aro 20" | Reforçado e resistente, para um desempenho em alto nível e segurança

**MATERIAL** Borracha

**PRESSÃO** 85/110PSI - 5.8/7.5BAR - 580/755KPa

**PESO** 637 gr

**EMBALAGEM** 25 peças

FOTOS MERAMENTE ILUSTRATIVAS. AS INFORMAÇÕES/CONFIGURAÇÕES DE PRODUTOS PODERÃO SOFRER ALTERAÇÕES SEM AVISO PRÉVIO.

ENTRE EM CONTATO COM O SEU CONSULTOR OU FALE COM O NOSSO TIME DE TELEVENDAS PELO (33) 3277-3030.

ARISUN



## PNEU ARISUN ALLURE

ROAD BIKE

TAMANHO	TPI	TIPO	CODIGO
700X23C	30	BANDA LEVE	06756
700X25C	30	BANDA LEVE	07789
700X25C	60	KEVLAR	07788
700X28C	120	KEVLAR	14263
700X32C	120	KEVLAR	14264
700X25C	27	SKINWALL	24102



## METRO CRUISER - ARISUN

ROAD BIKE

TAMANHO	TPI	TIPO	CODIGO
700X32C	27	SKINWALL	08657



## METRO TROOPER - ARISUN

ROAD BIKE

TAMANHO	TPI	TIPO	CODIGO
700X38C	30	BANDA LEVE	06759
700X23C	60	KEVLAR	-

ARISUN

FOTOS MERAMENTE ILUSTRATIVAS. AS INFORMAÇÕES/CONFIGURAÇÕES DE PRODUTOS PODERÃO SOFRER ALTERAÇÕES SEM AVISO PRÉVIO.

ENTRE EM CONTATO COM O SEU CONSULTOR OU FALE COM O NOSSO TIME DE TELEVENDAS PELO (33) 3277-3030.



## PNEU SKINWALL MOUNT BONA TANWALL ARISUN

### CROSS COUNTRY

**MATERIAL** Borracha

**PESO** 864 gr

**EMBALAGEM** 25 peças

TAMANHO	TPI	TIPO	CODIGO
29 X 2.10	27	SKINWALL	24098
29 X 2.35	27	SKINWALL	24100
29 X 2.35	60	KVELAR	24097

## CÂMARA – ARISUN

TAMANHO	VÁLVULA	CODIGO
29X1.75/2.35	PRESTA 48MM	06761 / 17876
29X1.75/2.35 SCHRADER	AMERICANA	07805 / 17877
700X18/25C	PRESTA 48MM	06762
700X25/38C	PRESTA 48MM	24106
700X18/25C	PRESTA 48 MM SUPERLITE	24108
700X25/38C	PRESTA 60MM	24107
700X18/25C	PRESTA 60MM	07807
700X18/25C	PRESTA 60MM SUPERLITE	24109
700X35/50C	PRESTA 48MM	06763
700X35/50C	PRESTA 60MM	07808
700X18/25C	PRESTA 80 MM SUPERLITE	24110
700X18/25C	PRESTA 80MM	24105
29 X 1.75/2.35	PRESTA 48MM	24103





## SRI68 - BEYOND

<b>CARACTERÍSTICA</b>	Pneu para MTB   Aro 29"   Com cravos   Medida 2.10 (54-622)   Pressão máxima 60 P.S.I / 4 bar   Material borracha / Arame / Nylon
<b>MARCA</b>	Beyond
<b>MATERIAL</b>	Borracha
<b>PESO</b>	1000 gr
<b>FATOR DE VENDA</b>	1 unidade
<b>EMBALAGEM</b>	50 unidades

24378

FOTOS MERAMENTE ILUSTRATIVAS. AS INFORMAÇÕES/CONFIGURAÇÕES DE PRODUTOS PODERÃO SOFRER ALTERAÇÕES SEM AVISO PRÉVIO.

ENTRE EM CONTATO COM O SEU CONSULTOR OU FALE COM O NOSSO TIME DE TELEVENDAS PELO (33) 3277-3030.



**ROCKBROS**



## Suporte para Caramanhola

MODELO	2009-14C
CARACTERÍSTICA	Leve e portátil   Design avançado com apelo para performance
MATERIAL	Alumínio
COR	Preto
PESO APROXIMADO	45 g
EMBALAGEM	1 peça
	13341



## Suporte para Caramanhola Nylon Modelo 07

CARACTERÍSTICAS	Design moderno   Fixação por 2 parafusos   Acompanha chave allen para instalação
MATERIAL	Nylon
COR	Preto
PESO APROXIMADO	47gr - peso referente kit (suporte, parafusos, chave allen)
EMBALAGEM	100 unidades
	22025



FOTOS MERAMENTE ILUSTRATIVAS. AS INFORMAÇÕES/CONFIGURAÇÕES DE PRODUTOS PODERÃO SOFRER ALTERAÇÕES SEM AVISO PRÉVIO.

ENTRE EM CONTATO COM O SEU CONSULTOR OU FALE COM O NOSSO TIME DE TELEVENDAS PELO (33) 3277-3030.

## Suporte para Caramanhola Modelo 02

**CARACTERÍSTICAS** Fixação por dois parafusos  
| Allen 4 mm

**MATERIAL** Alumínio

**COR** Preto

**PESO APROXIMADO** 27 g

**EMBALAGEM** 1 peça

14764



## Suporte para Caramanhola Modelo 03

**CARACTERÍSTICAS** Fixação por dois  
parafusos | Allen 4 mm

**MATERIAL** Alumínio

**COR** Preto

**PESO APROXIMADO** 34 g

**EMBALAGEM** 1 peça

14765



## Suporte para Caramanhola Nylon Modelo 04

**CARACTERÍSTICAS** Pintura emborrachada |  
Design moderno |  
Cor preta | Acompanha  
parafusos para fixação

**MATERIAL** Policarbonato - PC

**COR** Preto

**PESO APROXIMADO** 35gr - Peso referente  
kit (suporte, parafusos)

**EMBALAGEM** 100 unidades

22022



## Suporte para Caramanhola Alum. Modelo 06

**CARACTERÍSTICAS** Pintura anodizada  
| Design moderno  
| Cor preta  
| Acompanha parafusos  
para fixação

**MATERIAL** Alumínio

**COR** Preto

**PESO APROXIMADO** 41gr - Peso referente  
kit (suporte, parafusos)

**EMBALAGEM** 100 unidades

22024



## Suporte para Caramanhola Alum. Modelo 05

**CARACTERÍSTICAS** Pintura anodizada |  
Design moderno |  
Cor preta | Acompanha  
parafusos para fixação

**MATERIAL** Alumínio

**COR** Preto

**PESO APROXIMADO** 37gr - Peso referente  
kit (suporte, parafusos)

**EMBALAGEM** 100 unidades

22023



## Selim Passeio Gel

**CARACTERÍSTICAS** Gel | Vazado | 2 molas em silicone | Trilho de aço | Suporte de apoio para as mãos | Design moderno e confortável | Acompanha castanha de aço

**MATERIAL** Polietileno e Poliéster

**COR** Preto

**PESO APROXIMADO** 720gr - Incluindo castanha

**EMBALAGEM** 20 unidades

22026



## Selim MTB Vazado

**CARACTERÍSTICAS** Vazado | Estrutura de assento em polímero, espuma e couro sintético | Excelente acabamento | Não acompanha castanha

**MATERIAL** Polímero e aço

**COR** Preto

**MEDIDAS** 275x160mm

25002



## Manguito | XT9002

**MODELO** XT9002

**CARACTERÍSTICA** Unisex | Tamanho único | Proteção UV | Rápida secagem

**MATERIAL** Lycra / Coolmax

**EMBALAGEM** 50 peças

 16523

 16524



FOTOS MERAMENTE ILUSTRATIVAS. AS INFORMAÇÕES/CONFIGURAÇÕES DE PRODUTOS PODERÃO SOFRER ALTERAÇÕES SEM AVISO PRÉVIO.

ENTRE EM CONTATO COM O SEU CONSULTOR OU FALE COM O NOSSO TIME DE TELEVENDAS PELO (33) 3277-3030.

## Bomba De Ar Elétrica

PRESSÃO MÁXIMA	150 psi
TEMPO DE CARGA	Aproximadamente 2 horas
FUNÇÕES	Carro (0 a 2,5 BAR)   Moto (0 a 50 psi)   Mountain Bike (0 a 50 psi)   Ciclismo (0 a 120 psi) e bola (0 a 9 psi)
VISOR	Com seleção de função   Pressão desejada   Pressão atual   Nível de bateria
PESO	460 gramas
ESPECIFICAÇÕES	Recarregável via cabo USB-C   Compatível com válvula presta, americana e bola   Lanterna

24999



## Kit Macarrão Reparo Tubeless

PESO	42 gramas
ESPECIFICAÇÕES	Textura anti deslizante   Contém 10 refis de macarrão - 5 para furos de até 1,5mm e 5 para furos de até 3,5mm

25001



## Mini Bomba de Ar Elétrica

PRESSÃO MÁXIMA	100 psi
NÍVEL DE BATERIA	Luz verde 80% a 100%   Amarela 50% a 80%   Vermelha abaixo de 50%
MATERIAL	Alumínio
PESO	97 gramas
ESPECIFICAÇÕES	Recarregável via cabo USB-C   Compatível com válvula presta e americana

25000



FOTOS MERAMENTE ILUSTRATIVAS. AS INFORMAÇÕES/CONFIGURAÇÕES DE PRODUTOS PODERÃO SOFRER ALTERAÇÕES SEM AVISO PRÉVIO.

ENTRE EM CONTATO COM O SEU CONSULTOR OU FALE COM O NOSSO TIME DE TELEVENDAS PELO (33) 3277-3030.

## ■ Protetor de Quadro

<u>MARCA</u>	Rockbros
<u>CARACTERÍSTICA</u>	Fechamento em velcro
<u>EMBALAGEM</u>	01 peça
	16516



## Bomba de Ar RB-380G com Pé e Manômetro

MODELO	RB-380G
CARACTERÍSTICA	Bomba de alta pressão   Apoio para pé dobrável   Três adaptadores de bico
COMPRIMENTO DA MANGUEIRA	71 cm
COMPATIBILIDADE DE VÁLVULAS	Presta / Schrader (Americana)
PRESSÃO MÁXIMA	160 PSI (11 BAR)
MATERIAL	Alumínio / Nylon
PESO APROXIMADO	770g
EMBALAGEM	1 peça
	16518



## Bomba de Ar RB- GP6532B com Pé e Manômetro

MODELO	RB- GP6532B
CARACTERÍSTICA	Bomba de alta pressão   Duplo apoio para pé   Extenso alcance de aplicação   Dois adaptadores de bico
COMPRIMENTO DA MANGUEIRA	99 cm
COMPATIBILIDADE DE VÁLVULAS	Presta / Schrader (Americana)
PRESSÃO MÁXIMA	160 PSI (11 BAR)
MATERIAL	Alumínio
PESO APROXIMADO	1.11kg
EMBALAGEM	1 peça
	16519



## Bomba com Estojo para Remendo

<b>ESPECIFICAÇÃO</b>	Kit de ferramentas para reparos em câmaras de ar
<b>CARACTERÍSTICA</b>	Estojo de reparo de câmaras de ar
<b>PESO APROXIMADO</b>	135 g
<b>KIT</b>	1 mini bomba * 1 Par de Espátula * 6 remendo * 01 Bolsinha
<b>EMBALAGEM</b>	20 peças

19196



## Manopla | BT1001

<b>MODELO</b>	BT 1001
<b>CARACTERÍSTICA</b>	Manopla de espuma com anel de trava e tampa
<b>TRAVA</b>	Parafuso   Allen 3 mm
<b>MATERIAL</b>	Espuma / Alumínio
<b>COMPRIMENTO</b>	130 mm
<b>PESO</b>	63 g
<b>EMBALAGEM</b>	50 peça

16522



**ROCKBROS**



## Remendo Estojó 6 Unidades

ESPECIFICAÇÃO	Remendo para Câmara de Ar
CARACTERÍSTICA	Autocolante   Portátil
PESO	11 g (conjunto)
KIT	1 caixa / 1 Lixa de metal / 6 Remendo

EMBALAGEM 20 peças  
19198



## Remendo Patch Kit

ESPECIFICAÇÃO	Remendo para reparo de câmara de ar
CARACTERÍSTICA	Multifuncional   Portátil   Autocolante
PESO	87 g (conjunto)
EMBALAGEM DO PRODUTO	1 estojo / 1 lixa / 1 manual / 6 adesivos

EMBALAGEM 50 peças  
19204



## Fita Anti Furo 40 mm | Branca

ESPECIFICAÇÃO	Fita anti-furo
CARACTERÍSTICA	Proteger a câmara de ar
TAMANHO	29" MTB
LARGURA	40MM
COMPRIMENTO	2,30MT
ESPESSURA	0,5MM
PESO	121 g
KIT	1 PAR
EMBALAGEM	50 peças

19200



## ■ Espátula de Nylon para Retirar Pneu

**ESPECIFICAÇÃO** Para retirar pneu com trava de apoio que vai ao lado para facilitar a retirada do Pneu

**MATERIAL** Nylon Preto

**PESO** 0.27 Kg

**KIT** 2 espátulas

**EMBALAGEM** 50 peças

19202



## ■ Refletor/Retrovisor para Guidão Speed

**ESPECIFICAÇÃO** Refletor de guidão com 3 funções

**CARACTERÍSTICA** Fixação interna no guidão de speed com regulagem de ângulo (Retrovisor)

**MATERIAL** Nylon

**PESO** 0.42 Kg (embalagem)

**EMBALAGEM** 50 peças

19192



**ROCKBROS**

## ■ Extrator de Rolamento

**ESPECIFICAÇÃO** Instalador de rolamento

**CARACTERÍSTICA** Rolamentos de esferas modelo RC

**MATERIAL** Alumínio

**DIÂMETRO DA FERRAMENTA:** 2 mm / 3 mm / 4 mm / 5 mm / 6 mm / 8 mm / 10 mm / 12 mm / 14 mm

**PESO** 0.25 kg

**EMBALAGEM** 50 peças

19193



FOTOS MERAMENTE ILUSTRATIVAS. AS INFORMAÇÕES/CONFIGURAÇÕES DE PRODUTOS PODERÃO SOFRER ALTERAÇÕES SEM AVISO PRÉVIO.

ENTRE EM CONTATO COM O SEU CONSULTOR OU FALE COM O NOSSO TIME DE TELEVENDAS PELO (33) 3277-3030.

## Cortador de Mangueira e Agulha Freio a Disco Hidráulico

ESPECIFICAÇÃO	Cortador de mangueira de freio hidráulico
CARACTERÍSTICA	Cortador de mangueira e instalador de pino da oliva de freio hidráulico
MATERIAL	Nylon/ Alumínio
TAMANHO	94x69x14 mm / 3,7x2,71x0,51"
PESO	79 g
EMBALAGEM	25 peças

19194



## Chave Triângulo

ESPECIFICAÇÃO	Chave allen triângulo
CARACTERÍSTICA	Chave allen 4/5/6 mm
MATERIAL	Aço - meio emborrachado
TAMANHO	94x69x14 mm / 3,7x2,71x0,51"
PESO	82 g
EMBALAGEM	20 peças

19203



## Chave Allen com Alavanca e Catraca

ESPECIFICAÇÃO	Chave allen com catraca
CARACTERÍSTICA	Ferramentas multifuncionais   Dureza   Antiferrugem   Multifunção com 6 pontas
MATERIAL	Alumínio preto
KIT	Chaves allen 4/5/6   Chave Philips PH.2, T25/T30 estriada Plum 6 ângulos
COMPRIMENTO	10 cm
PESO	158 g
EMBALAGEM	20 peças

19201



FOTOS MERAMENTE ILUSTRATIVAS. AS INFORMAÇÕES/CONFIGURAÇÕES DE PRODUTOS PODERÃO SOFRER ALTERAÇÕES SEM AVISO PRÉVIO.

ENTRE EM CONTATO COM O SEU CONSULTOR OU FALE COM O NOSSO TIME DE TELEVENDAS PELO (33) 3277-3030.

## Kit Ferramenta Allen com Remendo

<b>ESPECIFICAÇÃO</b>	Estojo de ferramentas
<b>CARACTERÍSTICA</b>	Multifuncional portátil 16 em 1 - Kit de ferramentas para reparo de bicicletas Stainles
<b>TAMANHO</b>	8,5 * 12 * 7,5 cm
<b>COMPRIMENTO</b>	Cerca de 10cm
<b>PESO</b>	281 g/ peças
<b>CONTÉM</b>	1 Bolsa de Ferramenta Azul 1 Ferramenta Allen 16 em 1 multifuncional 1 cola de remendo 1 Lixa de metal de borracha 5 Remendos de Câmara 1 Par de Espátula para retirada do Pneu
<b>EMBALAGEM</b>	20 peças
	19199



## Chaveiro Allen 16 Funções

<b>ESPECIFICAÇÃO</b>	Chaveiro allen
<b>CARACTERÍSTICA</b>	Multifuncional portátil 16 em 1 - Kit de ferramentas para reparo de bicicletas Stainles
<b>TAMANHO</b>	4,4*9 CM
<b>COR</b>	Preta
<b>PESO</b>	205 g
<b>KIT</b>	<ul style="list-style-type: none"><li>• Ferramentas metálicas Cr-Mo</li><li>• 6 Hex 2. 2.5.3. 4. 5. 6 mm - Chave Allen</li><li>• 3 Chaves planas: 8,10,15 mm</li><li>• 3 Chaves de Caixa: 8,9,10 mm</li><li>• 1 Chave Fenda</li><li>• 1 Chave Phillips</li><li>• Chave Raio (ajuste)</li></ul>
<b>EMBALAGEM</b>	50 peças
	19197



## Maleta Ferramentas Bicicleta

ESPECIFICAÇÃO	Maleta de Ferramentas para Bicicleta
CARACTERÍSTICA	Kit Ferramentas   Aço carbono
TAMANHO	Tamanho da caixa 32.5 x 25 x 7cm
PESO	3.195 Kg
KIT	<ul style="list-style-type: none"><li>• 1 Kit Remendo com 6 Unidades Alto Colante, Lixa de Metal.</li><li>• 2 Ponta Chave de Fenda (Média e Grande)</li><li>• 2 Ponta Chave Phillips (Média e Grande)</li><li>• 1 Chave Phillips (Para ajuste do cambio)</li><li>• 1 Chave de Boca 8mm / 10mm</li><li>• 1 Chicote de Corrente</li><li>• 1 Chave de Movimento de Direção 30/32 + 36/40mm</li><li>• 2 Chaves de Cone - 13-15mm e 14-16mm</li><li>• 1 Extrator de Pedivela</li><li>• 1 Chave de Raio</li><li>• 6 Chave Allen 2 / 2,5 / 3 / 4 / 5 e 6mm</li><li>• 1 Chave de Pino Ajustável para Movimento Central e Roda Lire</li><li>• 1 Chave de Pedal - 15/16 e 15/17</li><li>• 1 Chave Inglesa - 0 a 21mm</li><li>• 1 Extrator de Corrente</li><li>• 1 Chave Allen - 8mm (Para remoção do braço da manivela)</li><li>• 3 Unidades de Espátula de Pneu</li><li>• 3 Chave Hexagonal - 8 / 9 / 10mm</li><li>• 1 Extrator de Cassete</li><li>• 1 Chave Extratora para Movimento Central</li><li>• 1 Calibrador - Válvula Americana</li></ul>

EMBALAGEM 05 peças

19195



FOTOS MERAMENTE ILUSTRATIVAS. AS INFORMAÇÕES/CONFIGURAÇÕES DE PRODUTOS PODERÃO SOFRER ALTERAÇÕES SEM AVISO PRÉVIO.

ENTRE EM CONTATO COM O SEU CONSULTOR OU FALE COM O NOSSO TIME DE TELEVENDAS PELO (33) 3277-3030.

24983



24984



24985



ESTES MATERIAIS SÃO EXEMPLOS. AS INFORMAÇÕES CONTEÚDO DE PRODUTOS PODERÃO SER SEMPRE ALTERADAS SEM AVISO PRÉVIO.

ENTRE EM CONTATO COM O SEU CONSULTOR OU FALE COM O NOSSO TIME DE TELEVENDAS PELO (33) 3277-3030.

## Óculos Ciclismo

MODELO	10168
LENTE	Fotocromático
COR	Cinza
ACESSORIOS	Case, lenços e suporte para lentes de grau
QUANT. DE LENTES	Única
PESO	29 gramas
ESPECIFICAÇÕES	Suporte nasal ajustável

24983



## Óculos Ciclismo

MODELO	10179
LENTE	Fotocromático espelhado
COR	Branco
ACESSORIOS	Case, lenços e suporte para lentes de grau
QUANT. DE LENTES	Única
PESO	29 gramas
ESPECIFICAÇÕES	Suporte nasal ajustável

24984



## Óculos Ciclismo

MODELO	10179
LENTE	Fotocromático espelhado
COR	Preto
ACESSORIOS	Case, lenços e suporte para lentes de grau
QUANT. DE LENTES	Única
PESO	29 gramas
ESPECIFICAÇÕES	Suporte nasal ajustável

24985



24986



24987



24988



FOTOS MERAMENTE ILUSTRATIVAS. AS INFORMAÇÕES/CONFIGURAÇÕES DE PRODUTOS ILUSTRADO SOBRE ALICATAÇÕES SEM ALICATAÇÃO

ENTRE EM CONTATO COM O SEU CONSULTOR OU FALE COM O NOSSO TIME DE TELEVENDAS PELO (33) 3277-3030.



## Óculos Ciclismo

MODELO	14110001001
LENTE	Espelhada
COR	Azul
ACESSORIOS	Case, lenços e suporte para lentes de grau
QUANT. DE LENTES	Única
PESO	29 gramas
ESPECIFICAÇÕES	Suporte nasal ajustável

24986



## Óculos Ciclismo

MODELO	10136
LENTE	Fotocromático
COR	Azul
ACESSORIOS	Case, lenços e suporte para lentes de grau
QUANT. DE LENTES	Única
PESO	24 gramas
ESPECIFICAÇÕES	Proteção UV, suporte nasal ajustável

24987



## Óculos Ciclismo

MODELO	10137
LENTE	Fotocromático
COR	Vermelho
ACESSORIOS	Case, lenços e suporte para lentes de grau
QUANT. DE LENTES	Única
PESO	24 gramas
ESPECIFICAÇÕES	Proteção UV, suporte nasal ajustável

24988



24989



24990



24991



FOTOS MERAMENTE ILUSTRATIVAS. É NORMAL QUE CONFIGURAÇÕES DE PRODUTOS NADERÃO SOFRER ALTERAÇÕES SEM AVISO PRÉVIO.

ENTRE EM CONTATO COM O SEU CONSULTOR OU FALE COM O NOSSO TIME DE TELEVENDAS PELO (33) 3277-3030.

## Óculos Ciclismo

MODELO	10173
LENTE	Fotocromático
COR	Preto/Vermelho
ACESSORIOS	Case, lenços e suporte para lentes de grau
QUANT. DE LENTES	Única
PESO	32 gramas
ESPECIFICAÇÕES	Proteção UV, suporte nasal ajustável

24989



## Óculos Ciclismo

MODELO	10174
LENTE	Fotocromático
COR	Azul
ACESSORIOS	Case, lenços e suporte para lentes de grau
QUANT. DE LENTES	Única
PESO	32 gramas
ESPECIFICAÇÕES	UV400, Suporte nasal ajustável

24990



## Óculos Ciclismo

MODELO	10175
LENTE	Fotocromático
COR	Preto
ACESSORIOS	Case, lenços e suporte para lentes de grau
QUANT. DE LENTES	Única
PESO	32 gramas
ESPECIFICAÇÕES	Suporte nasal ajustável

24991



24992



24993



24994



FOR ALL THE FAMILY. DIVERSAS. AS INFORMAÇÕES/CONFIGURAÇÕES DE PRODUTOS PODERÃO SOFRER ALTERAÇÕES SEM AVISO PRÉVIO.

ENTRE EM CONTATO COM O SEU CONSULTOR OU FALE COM O NOSSO TIME DE TELEVENDAS PELO (33) 3277-3030.

## Óculos Ciclismo

MODELO	10172
LENTE	Fotocromático
COR	Branco
ACESSÓRIOS	Case, lenços e suporte para lentes de grau
QUANT. DE LENTES	Única
PESO	32 gramas
ESPECIFICAÇÕES	Proteção UV, suporte nasal ajustável

24992



## Óculos Ciclismo

MODELO	14110006002
LENTE	Fotocromático espelhado
COR	Branco
ACESSÓRIOS	Case, lenços e suporte para lentes de grau
QUANT. DE LENTES	Única
PESO	32 gramas
ESPECIFICAÇÕES	Proteção UV, suporte nasal ajustável

24993



## Óculos Ciclismo

MODELO	14110006003
LENTE	Espelhada polarizada
COR	Verde
ACESSÓRIOS	Case, lenços e suporte para lentes de grau
QUANT. DE LENTES	Única
PESO	32 gramas
ESPECIFICAÇÕES	Proteção UV, suporte nasal ajustável

24994



24995



24996



FOTOS MERAMENTE ILUSTRATIVAS. AS INFORMAÇÕES, CONFIGURAÇÕES DE PREÇOS PODERÃO SOFRER ALTERAÇÕES SEM AVISO PRÉVIO.

ENTRE EM CONTATO COM O SEU CONSULTOR OU FALE COM O NOSSO TIME DE TELEVENDAS PELO (33) 3277-3030.

## Óculos Ciclismo

MODELO	14110006004
LENTE	Fotocromático
COR	Preto
ACESSÓRIOS	Case, lenços e suporte para lentes de grau
QUANT. DE LENTES	Única
PESO	32 gramas
ESPECIFICAÇÕES	Proteção UV, suporte nasal ajustável

24995



## Óculos Ciclismo

MODELO	14110006005
LENTE	Espelhada polarizada
COR	Preto/Vermelho
ACESSÓRIOS	Case, lenços e suporte para lentes de grau
QUANT. DE LENTES	Única
PESO	32 gramas
ESPECIFICAÇÕES	Proteção UV, suporte nasal ajustável

24996



24997



24998



FOTOS MERAMENTE ILUSTRATIVAS. AS INFORMAÇÕES/CONDIÇÕES DE PRODUTOS PODERÃO SOFRER ALTERAÇÕES SEM AVISO PRÉVIO.

ENTRE EM CONTATO COM O SEU CONSULTOR OU FALE COM O NOSSO TIME DE TELEVENDAS PELO (33) 3277-3030.



## Óculos Ciclismo

MODELO	SP225WR
LENTE	Espelhada polarizada
COR	Branco
ACESSORIOS	Case, lenços e suporte para lentes de grau
QUANT. DE LENTES	Única
PESO	25 gramas
ESPECIFICAÇÕES	Proteção UV, suporte nasal ajustável

24997



## Óculos Ciclismo

MODELO	SP225GB
LENTE	Espelhada polarizada
COR	Cinza
ACESSORIOS	Case, lenços e suporte para lentes de grau
QUANT. DE LENTES	Única
PESO	25 gramas
ESPECIFICAÇÕES	Proteção UV, suporte nasal ajustável

24998





**ZTT** 



## CASSETE 12S XD 9-50T

Característica	Cassete 12V. 9/50 Dentes - Arranha e Cog 50 de Alumínio - Padrão XD - Escalonamento 9/11/13/15/18/21/24/28/32/36/42/50 T
Material	Aço de alta resistência entre os corgs 9-42T e liga de alumínio 7075 no cog 50T
Peso	510 g
Embalagem	20 peças

19493



## GUIA DE CORRENTE MODELO CG-02

Característica	Guia de Corrente
Material	Liga de alumínio 7075 ultraleve com usinagem CNC de alta qualidade. Peso leve, mas com alta resistência. Abraçadeira 35mm, acompanha calço redutor para Seat Tube 31.8mm. Montagem com braçadeira e montagem direta tipo E. Usinagem CNC de alta qualidade
Peso	52 g
kit	01 Guia de corrente, 04 Arruelas, 01 Protetor/Redutor de quadro, 01 Parafuso com porca
Embalagem	50 peças

19495



## ARRUELA BASE GARFO TAPERAD

Característica	Cone inferior para Garfo Taperad
Material	Alumínio
Peso	6 g
Embalagem	50 peças

19496



## HEADSET EXPANDER PLUG

Característica	Aranha/Expander para aperto da caixa de direção
	Aberta 22.2 ≤ 25.4 mm - Compatível com espigas Head Set de alumínio de 28,6 mm, carbono, aço, garfo de titânio. Fácil de instalar
Material	Alumínio
Peso	66 g
Embalagem	50 peças
	19497



## ADAPTADOR CENTER LOCK PARA 6 PARAFUSOS

Característica	Adaptador Center Lock para 6 Parafuso
	Adaptador Center Lock para discos de 6 parafusos compatível com eixos de 9/12/15mm
Material	Alumínio
Peso	32 g
Embalagem	50 peças
	19498



## ADAPTADOR CENTER LOCK PARA 6 PARAFUSOS 15X100 PARA 15X110

Característica	Adaptador Center Lock para 6 Parafuso
	Adaptador Center Lock para discos de 6 parafusos para converter cubos equipados com eixo 15x100 mm para serem usados em suspensões com o OLD de 15x110mm. Acompanha 02 arruelas calço de 0.5x15 mm
Material	Alumínio
Peso	46 g
Embalagem	50 peças
	19499





## ADAPTADOR CENTER LOCK PARA 6 PARAFUSOS 12X142 PARA 12X148

Característica	Adaptador Center Lock para 6 Parafusos
	Adaptador Center Lock para discos de 6 parafusos para converter cubos equipados com eixo 12x142 mm para serem usados em quadros Boost (12x148mm). Acompanha 02 arruelas calço de 0.3x12 mm
Material	Alumínio
Peso	40 g
Embalagem	50 peças
	19500



## ADAPTADOR DIANTEIRO 180MM PARA PINÇA FREIO POST MOUNT

Característica	Adaptador de pinça dianteiro para discos 180mm
	Adaptador dianteiro de freio a disco MTB para rotor 180mm, liga de alumínio 7075 leve de alta resistência com tratamento de endurecimento T6
Material	Alumínio
Peso	30 g
Embalagem	50 peças
	19501



## ALICATE TRAVA E DESTRAVA CORRENTE

Característica	Alicate para extração da emenda de engate rápido da corrente (Tipo: Power Link, Missing Link)
	Alicate Multifunções 4 em 1 - Extrator de emenda, Instalador de emenda, Espátula e Estojo para guardar emenda de corrente
Material	Alumínio
Peso	33 g
Embalagem	50 peças
	19502

FOTOS MERAMENTE ILUSTRATIVAS. AS INFORMAÇÕES/CONFIGURAÇÕES DE PRODUTOS PODERÃO SOFRER ALTERAÇÕES SEM AVISO PRÉVIO.

ENTRE EM CONTATO COM O SEU CONSULTOR OU FALE COM O NOSSO TIME DE TELEVENDAS PELO (33) 3277-3030.



## MEDIDOR CORRENTE

Característica	Ferramenta para verificar a vida útil da corrente.
	Verifica a variação de medida da corrente de 0mm à 1,00 mm (Régua 0/ 0.25/ 0.50/ 0.75/ 1.0 mm), de fácil manuseio
Material	Liga de alumínio CNC
Peso	42 g
Embalagem	50 peças
	19503



## FERRAMENTA INSTALAR ARANHA GARFO AHEAD

Característica	Ferramenta para instalar aranha
	Adaptador para garfo de 28,6 mm em Alumínio com O'ring para dar estabilidade e diminuição de atritos na espiga. Ferramenta durável
Material	Alumínio/Aço
Tamanho	Comprimento 100 mm/ Diâmetro 34.5mm
Peso	232 g
Embalagem	50 peças
	19504



## EXTRATOR PORCA MOV CENTRAL DUB

Característica	Extrator de Movimento central
	Extrator de movimento central Duplo (DUB e Hollowtech), Compatível com movimentos Sram DUB, Shimano Hollowtech II e X-TIME. Acompanha Ferramenta de aperto do parafuso do eixo central padrão Shimano Hollowtech II
Material	Alumínio
Material	Comprimento 230mm/ Largura ≤ 62mm/ Encaixes da Ferramenta de 44 mm
Peso	55 g
Embalagem	50 peças
	19505

FOTOS MERAMENTE ILUSTRATIVAS. AS INFORMAÇÕES/CONFIGURAÇÕES DE PRODUTOS PODERÃO SOFRER ALTERAÇÕES SEM AVISO PRÉVIO.

ENTRE EM CONTATO COM O SEU CONSULTOR OU FALE COM O NOSSO TIME DE TELEVENDAS PELO (33) 3277-3030.





## FERRAMENTA PASSADOR CABEAMENTO INTERNO V1.0

Característica	Ferramenta para passar cabos internos
	Ferramenta para passar cabos, Ímã flexível, Tampa removível com ímã principal, Fio flexível com ímã e ponta rosqueada e Encaixe de mangueira hidráulica
Material	Alumínio/Aço
Peso	48 g
Embalagem	50 peças
	19506



## FERRAMENTA PASSADOR CABEAMENTO INTERNO V0.8

Característica	Ferramenta para passar cabos internos
	Ferramenta para passar cabos, Ímã flexível, Tampa removível com ímã principal, Fio flexível com ímã e ponta rosqueada e Encaixe de mangueira hidráulica.
Material	Alumínio/Aço
Peso	49 g
Embalagem	50 peças
	19507



## ALICATE CORTADOR CABO E CONDUÍTE

Característica	Alicate de corte
	Alicate para corte de cabos e conduítes de Bicicleta
Material	Aço - cabo emborrachado
Tamanho	200mm
Peso	326 g
Embalagem	50 peças
	19508

## ALICATE TRAVA CORRENTE ZTTO

- Característica
- Alicate p/ instalação de emenda de corrente
  - Marca ztto
  - Acompanha ferramenta auxiliar para segurar os elos da corrente
  - Material aço
  - Compatível com emendas power link e missinglink

Material Aço

Peso +-45gr – peso ao par

Embalagem 50 unidades

23779



## ALICATE DESTRAVA CORRENTE ZTTO

- Característica
- Alicate p/ extração de emenda de corrente
  - Marca ztto
  - Acompanha ferramenta auxiliar para segurar os elos da corrente
  - Material aço
  - Compatível com emendas power link e missinglink

Material Aço

Peso +-50gr – peso ao par

Embalagem 50 unidades

23780



## EXTRATOR MOV CENTRAL INTEGRADO MOD. 01 PT ZTTO

- Característica
- Chave para extração mov. Central
  - Marca ztto
  - Material alumínio
  - Medidas 49mm/ 16 entalhes
  - Compatível com movimento press fit bb386evo

Material Alumínio

Peso • Peso +-48gr

Embalagem 50 unidades

23762





## EXTRATOR MOV CENTRAL INTEGRADO MOD. 02 PT ZTTO

Característica	<ul style="list-style-type: none"><li>• Chave para extração mov. Central</li><li>• Marca ztto</li><li>• Material alumínio</li><li>• Medidas 48.5mm/ 12 entalhes</li><li>• Compatível com movimento press fit bb386 (bsa30/ ita30)</li></ul>
Material	Alumínio
Peso	• Peso +-48gr
Embalagem	50 unidades  23763



## EXTRATOR MOV CENTRAL INTEGRADO MOD. 03 PT ZTTO

Característica	<ul style="list-style-type: none"><li>• Chave para extração mov. Central</li><li>• Marca ztto</li><li>• Material alumínio</li><li>• Medidas 44mm/ 16 entalhes</li><li>• Compatível com movimento bsa integrado (shimano / xtime)</li></ul>
Material	Alumínio
Peso	• Peso +-50gr
Embalagem	50 unidades  23764



## EXTRATOR MOV CENTRAL INTEGRADO MOD. 04 PT ZTTO

Característica	<ul style="list-style-type: none"><li>• Chave para extração mov. Central</li><li>• Marca ztto</li><li>• Material alumínio</li><li>• Medidas 44mm/ 16 entalhes - 46mm/ 24 entalhes</li><li>• Compatível com movimento bsa integrado (shimano / dub / xtime)</li></ul>
Material	Alumínio
Peso	+56gr - peso referente ao extrator de central e parafuso do eixo
Embalagem	50 unidades  23765



## ADAPTADOR EXTRATOR MOV. CENTRAL BBT-1 PT ZTTO

- Característica
- Chave para extração mov. Central
  - Marca ztto
  - Funciona com chave auxiliar allen 10mm e/ou chave cachimbo 3/8 (não acompanham a ferramenta)
  - Material alumínio
  - Compatível com vários movimentos centrais

Material Aluminio

- Referência / compatibilidade:
- Sm-bb52 (hollowtech ii)
  - Sm-bbr60 (tl-fc25)
  - Sm-bb93 (tl-fc24)
  - Sr-dub
  - Mega bsa30 / bb386 evo

Peso +-94gr

Embalagem 50 unidades

23766



## ADAPTADOR EXTRATOR MOV. CENTRAL BBT-2 PT ZTTO

- Característica
- Chave para extração mov. Central
  - Marca ztto
  - Funciona com chave auxiliar allen 10mm e/ou chave sextavada (não acompanham a ferramenta)
  - Material alumínio
  - Compatível com vários movimentos centrais

Material Aluminio

- Referência / compatibilidade:
- Sm-bb52 (hollowtech ii)
  - Sm-bbr60 (tl-fc25)
  - Sm-bb93 (tl-fc24)
  - Sr-dub
  - Mega bsa30 / bb386 evo

Peso +-96gr

Embalagem 50 unidades

23767



## FERRAMENTA INSTALA E EXTRATO MOV CENTRAL ZTTO

- Característica
- Chave para extração mov. Central
  - Chave para extração coroa direct shimano (padrão center lock)
  - Marca ztto
  - Funciona com chave auxiliar ztto (código jpp 23764) e/ou chave sextavada (não acompanham a ferramenta)
  - Material alumínio
  - Compatível com movimentos centrais shimano m7100 / m8100 / m9100

Material Aluminio

Peso +-42gr

Embalagem 50 unidades

23773



## CHAVE PRE-CARGA AJUSTE GARFO ALUM. MOD 01 ZTTO

Característica	<ul style="list-style-type: none"><li>• Chave para reparo em suspensão ztto</li><li>• Marca ztto</li><li>• Material alumínio</li></ul>
Material	Alumínio
Referência / compatibilidade:	<ul style="list-style-type: none"><li>• Instalação e extração do ajuste de preload</li><li>• Ideal para manutenções em suspensões suntour e similares</li><li>• Compatível com suspensões rst e suntour xct, xcm e xcr</li></ul>
Peso	+16gr
Embalagem	50 unidades
	23756



## CHAVE PRE-CARGA AJUSTE GARFO ALUM. MOD 02 ZTTO

Característica	<ul style="list-style-type: none"><li>• Chave para reparo em suspensão ztto</li><li>• Marca ztto</li><li>• Material alumínio</li></ul>
Material	Alumínio
Referência / compatibilidade:	<ul style="list-style-type: none"><li>• Instalação e extração do ajuste de preload</li><li>• Ideal para manutenções em suspensões suntour e similares</li><li>• Compatível com suspensões rst e suntour xct, xcm e xcr</li></ul>
Peso	+20gr
Embalagem	50 unidades
	23757



## FERRAMENTA DE INSTALAÇÃO DRIVER LIMPADOR ZTTO

Característica	<ul style="list-style-type: none"><li>• Ferramenta para instalação de raspadores</li><li>• Marca ztto</li><li>• Material alumínio</li></ul>
Material	Alumínio
Referência / compatibilidade:	<ul style="list-style-type: none"><li>• Ideal para manutenções em suspensões</li><li>• Tamanhos disponíveis</li></ul> 32 à 34mm / 35 à 36mm / 38 à 40mm
Peso	+340gr - peso referente ao código 23758
Embalagem	20 unidades
Tamanho: 32 a 34	23758
Tamanho: 35 a 36	23759
Tamanho: 38 a 40	23760



FOTOS MERAMENTE ILUSTRATIVAS. AS INFORMAÇÕES/CONFIGURAÇÕES DE PRODUTOS PODERÃO SOFRER ALTERAÇÕES SEM AVISO PRÉVIO.

ENTRE EM CONTATO COM O SEU CONSULTOR OU FALE COM O NOSSO TIME DE TELEVENDAS PELO (33) 3277-3030.

## FERRAMENTA DE INSTALAÇÃO DRIVER LIMPADOR PT ZTTO

Característica	<ul style="list-style-type: none"><li>• Ferramenta para instalação de raspadores</li><li>• Marca ztto</li><li>• Material alumínio</li></ul>
Material	Alumínio
Referência / compatibilidade:	<ul style="list-style-type: none"><li>• Ideal para manutenções em suspensões</li><li>• Medidas 32, 34, 35 e 36mm</li></ul>
Peso	+72gr
Embalagem	50 unidades

23761



## FERRAMENTA REMOVE ARANHA GARFO AHEAD ZTTO

Característica	<ul style="list-style-type: none"><li>• Ferramenta remover aranha da espiga</li><li>• Marca ztto</li><li>• Material alumínio/aço</li></ul>
Material	Alumínio / Aço
Referência / compatibilidade:	<ul style="list-style-type: none"><li>• Ideal para manutenções em suspensões</li><li>• Comprimento 28.2mm</li><li>• Diâmetro 18mm</li></ul>
Peso	+212gr
Embalagem	20 unidades

23774



## CONJUNTO FERRAMENTAS EXTRATOR EIXO ROLAMENTO ZTTO

Característica	<ul style="list-style-type: none"><li>• Ferramenta para instalação e remoção de rolamentos</li><li>• Material em liga de Alumínio e aço</li><li>• Compatível com Rolamentos 6000/ 6001/ 6900/ 6901/ 6902/ 6903 etc...</li><li>• Kit 22 peças</li></ul>
Material	Alumínio / Aço
Box:	<ul style="list-style-type: none"><li>• ADAPTADORES PARA INSTALAÇÃO DE ROLAMENTOS</li><li>• ADAPTADORES PARA REMOÇÃO DE ROLAMENTOS</li><li>• BARRA ROSQUEADA</li><li>• CALÇOS</li></ul>
Peso	3.105 gr
Embalagem	5 unidades

23769



## MALETA FERRAMENTAS MOV. CENTRAL PRESSFIT ZTTO

Característica	<ul style="list-style-type: none"> <li>Ferramenta para instalação e remoção de movimento central padrão press fit</li> <li>Material em Liga de Alumínio e Aço</li> <li>Compatível com BB86/ BB30/ BB91/ BB92/ PF30, ETC...</li> <li>Kit com 14 peças</li> </ul>
Material	Alumínio / Aço
Box	<ul style="list-style-type: none"> <li>ALLEN 8MM</li> <li>ARRUELA Ø30</li> <li>CILINDRO BB24/30</li> <li>ENGATE 1 – 25X37 / 30X42MM</li> <li>ENGATE 2 – 22X37 / 30X42MM</li> <li>ENGATE 3 – 22X37 / 24X30MM</li> <li>PARAFUSO HEXAGONAL</li> <li>TAMPA DE REMOÇÃO HEXAGONAL</li> <li>TAMPA DE REMOÇÃO 52.5X59.3MM</li> <li>TAMPA DE REMOÇÃO 44.4X54.4MM</li> <li>02 PUXADORES COM FENDA</li> <li>01 PUXADOR INTEIRIÇO</li> </ul>
Peso	968gr (peso referente a maleta completa)
Embalagem	5 unidades

23768



## MOVIMENTO CENTRAL PRESS FIT BB86/92 ZTTO

Característica	<ul style="list-style-type: none"> <li>Movimento central press fit BB86</li> <li>Marca ztto</li> <li>Material alumínio</li> <li>Padrão Shimano</li> <li>Diâmetro Externo 41mm</li> <li>Diâmetro do Eixo 24mm</li> <li>Rolamentos de cerâmica</li> <li>Compatível BB 86/90/92 mm   41mm</li> <li>Ferramenta compatível 44mm/ 16 entalhes (referência catálogo JPP 23766/23767)</li> </ul>
Material	Alumínio
Peso	92gr
Embalagem	20 unidades

23741



## MOVIMENTO CENTRAL PRESS FIT BB386EVO ZTTO

Característica	<ul style="list-style-type: none"> <li>Movimento central press fit BB386</li> <li>Marca ztto</li> <li>Material alumínio</li> <li>Padrão DUB</li> <li>Diâmetro Externo 46mm</li> <li>Diâmetro do Eixo 28.9 mm</li> <li>Compatível 86 mm   46 mm</li> <li>Acompanha Arruelas calço</li> <li>Ferramenta compatível 49mm/ 16 entalhes (referência catálogo JPP 23766/23767)</li> </ul>
Material	Alumínio
Peso	120gr (peso referênte ao movimento centrale aruelas calço)
Embalagem	20 unidades

23742



FOTOS MERAMENTE ILUSTRATIVAS. AS INFORMAÇÕES/CONFIGURAÇÕES DE PRODUTOS PODERÃO SOFRER ALTERAÇÕES SEM AVISO PRÉVIO.

ENTRE EM CONTATO COM O SEU CONSULTOR OU FALE COM O NOSSO TIME DE TELEVENDAS PELO (33) 3277-3030.

## PAQUÍMENTO DIGITAL LCD 0 A 150MM ZTTO

Característica	<ul style="list-style-type: none"> <li>• Paquímetro Digital</li> <li>• Marca ztto</li> <li>• Material nylon</li> <li>• Faixa de medição 0-150mm/0-6in</li> <li>• Resolução 0.1mm/ 0.01in</li> <li>• Precisão <math>\pm 0.2\text{mm}/ 0.01\text{in}</math></li> <li>• Display LCD</li> <li>• Bateria LR44 - Incluso no produto</li> </ul>
Material	Nylon
Peso	+144gr (peso referente ao paquímetro com case)
Embalagem	10 unidades
	23776



## KIT ADAPTADOR BOOST DIANT/TRAS. C/ PARAFUSO ZTTO

Característica	<p>Kit Conversor BOOST (12x148 / 15x110)</p> <ul style="list-style-type: none"> <li>• Kit adaptador ZTTO</li> <li>• Marca ztto</li> <li>• Material alumínio</li> <li>• Acompanha parafusos de fixação do disco</li> </ul>
Kit	<ul style="list-style-type: none"> <li>• 02 adaptadores de Eixo Traseiro (3x12mm)</li> <li>• 02 adaptadores de Eixo Dianteiro (5x15mm)</li> <li>• 01 espaçador de disco traseiro para 6 parafusos</li> <li>• 01 espaçador de disco dianteiro para 6 parafusos</li> <li>• 12 parafusos para fixação dos discos</li> </ul>
Material	Alumínio
Peso	58gr (kit completo)
Embalagem	20 unidades
	23743



## ADAPTADOR DE FREIO DISCO DIANT. 140/160MM ZTTO

Característica	<ul style="list-style-type: none"> <li>• Kit adaptador para freio flat 160mm</li> <li>• Marca ztto</li> <li>• Material alumínio</li> <li>• Compatível com quadro com sistema de fixação flat</li> <li>• Conversor de 140mm para disco 160mm</li> <li>• Kit acompanha parafuso para fixação</li> </ul>
Material	Alumínio
Peso	+34gr (peso referente ao kit)
Embalagem	50 unidades
	23744



FOTOS MERAMENTE ILUSTRATIVAS. AS INFORMAÇÕES/CONFIGURAÇÕES DE PRODUTOS PODERÃO SOFRER ALTERAÇÕES SEM AVISO PRÉVIO.

ENTRE EM CONTATO COM O SEU CONSULTOR OU FALE COM O NOSSO TIME DE TELEVENDAS PELO (33) 3277-3030.

## PASTILHA DE FREIO A DISCO SEMI-METALICA MDO. 01 ZTTO

Característica	<ul style="list-style-type: none"><li>• Pastilha de freio a disco semi-metálica</li><li>• Marca ztto</li><li>• Material resina e aço</li><li>• Compatível com freio SRAM e AVID (XO / XX / DB LEVEL/ TL LEVEL/ T LEVEL/ ELIXIR)</li></ul>
Material	Resina e Aço
Peso	+22gr (peso referênte ao PAR)
Embalagem	50 unidades
	23745



## PASTILHA DE FREIO A DISCO FULL-METÁLICA MDO. 01 ZTTO

Característica	<ul style="list-style-type: none"><li>• Pastilha de freio a disco metálica</li><li>• Marca ztto</li><li>• Material aço</li><li>• Compatível com freio SRAM e AVID (XO / XX / DB LEVEL/ TL LEVEL/ T LEVEL/ ELIXIR)</li></ul>
Material	Aço
Peso	+24gr (peso referênte ao PAR)
Embalagem	50 unidades
	23746



## PASTILHA DE FREIO A DISCO SEMI-METÁLICA MDO. 02 ZTTO

Característica	<ul style="list-style-type: none"><li>• Pastilha de freio a disco semi-metálica</li><li>• Marca ztto</li><li>• Material resina e aço</li><li>• Compatível com freio SHIMANO (M975 / M966 / M965 / M800 / M775 / M776 / M765 / M665 / M601 / M596 / M595 / M585 / M545 / M535 / R505 / S501 / S500 / T655 / T605)</li></ul>
Material	Resina e Aço
Peso	+22gr (peso referênte ao PAR)
Embalagem	50 unidades
	23747



## PASTILHA DE FREIO A DISCO FULL-METALICA MDO. 02 ZTTO

Característica	<ul style="list-style-type: none"><li>• Pastilha de freio a disco metálica</li><li>• Marca ztto</li><li>• Material aço</li><li>• Compatível com freio SHIMANO (M975 / M966 / M965 / M800 / M775 / M776 / M765 / M665 / M601 / M596 / M595 / M585 / M545 / M535 / R505 / S501 / S500 / T655 / T605)</li></ul>
Material	Aço
Peso	+24gr (peso referênte ao PAR)
Embalagem	50 unidades
	23748



FOTOS MERAMENTE ILUSTRATIVAS. AS INFORMAÇÕES/CONFIGURAÇÕES DE PRODUTOS PODERÃO SOFRER ALTERAÇÕES SEM AVISO PRÉVIO.

ENTRE EM CONTATO COM O SEU CONSULTOR OU FALE COM O NOSSO TIME DE TELEVENDAS PELO (33) 3277-3030.

## PASTILHA DE FREIO A DISCO SEMI-METÁLICA MDO. 03 ZTTO

Característica	<ul style="list-style-type: none"><li>• Pastilha de freio a disco semi-metálica</li><li>• Marca ztto</li><li>• Material Resina e aço</li><li>• Compatível com freio SHIMANO (M985 / M988 / M785 / M615 / M666 / M675 / XT / XTR / SLX)</li></ul>
Material	Resina e Aço
Peso	+24gr (peso referênte ao PAR)
Embalagem	50 unidades
	23749



## PASTILHA DE FREIO A DISCO FULL-METÁLICA MDO. 03 ZTTO

Característica	<ul style="list-style-type: none"><li>• Pastilha de freio a disco metálica</li><li>• Marca ztto</li><li>• Material aço</li><li>• Compatível com freio SHIMANO (M985 / M988 / M785 / M615 / M666 / M675 / XT / XTR / SLX)</li></ul>
Material	Aço
Peso	+26gr (peso referênte ao PAR)
Embalagem	50 unidades
	23750



## PASTILHA DE FREIO A DISCO SEMI-METÁLICA MDO. 04 ZTTO

Característica	<ul style="list-style-type: none"><li>• Pastilha de freio a disco semi-metálica</li><li>• Marca ztto</li><li>• Material Resina e aço</li><li>• Compatível com freio SHIMANO (M575 / M525 / M495 / M486 / M485 / M478 M465 / M447 / M446 / M445 / M416 / M415 / M4050 / M395 / M375 / M355 / M675 / M615)</li></ul>
Material	Resina e Aço
Peso	+26gr (peso referênte ao PAR)
Embalagem	50 unidades
	23751



## PASTILHA DE FREIO A DISCO FULL-METÁLICA MDO. 04 ZTTO

Característica	<ul style="list-style-type: none"><li>• Pastilha de freio a disco metálica</li><li>• Marca ztto</li><li>• Material aço</li><li>• Compatível com freio SHIMANO (M575 / M525 / M495 / M486 / M485 / M478 M465 / M447 / M446 / M445 / M416 / M415 / M4050 / M395 / M375 / M355 / M675 / M615)</li></ul>
Material	Aço
Peso	+28gr (peso referênte ao PAR)
Embalagem	50 unidades
	23752



FOTOS MERAMENTE ILUSTRATIVAS. AS INFORMAÇÕES/CONFIGURAÇÕES DE PRODUTOS PODERÃO SOFRER ALTERAÇÕES SEM AVISO PRÉVIO.

ENTRE EM CONTATO COM O SEU CONSULTOR OU FALE COM O NOSSO TIME DE TELEVENDAS PELO (33) 3277-3030.



## CONECTOR E OLIVA FREIO DISCO HID. MOD 01 ZTTO

Característica	<ul style="list-style-type: none"><li>• Kit Oliva e Pino ztto</li><li>• Marca ztto</li><li>• Material Cobre</li><li>• Compatível com mangueira de disco SHIMANO BH90</li><li>• Pino +- 11.5mm de comprimento</li><li>• Kit com 10 conjuntos de Oliva e Pino</li></ul>
Material	Cobre
Peso	+1-1gr (peso referênte a um conjunto de Oliva e Pino)
Embalagem	50 unidades
	23753



## CONECTOR E OLIVA FREIO DISCO HID. MOD 02 ZTTO

Característica	<ul style="list-style-type: none"><li>• Kit Oliva e Pino ztto</li><li>• Marca ztto</li><li>• Material Cobre</li><li>• Compatível com mangueira de disco SHIMANO BH59</li><li>• Pino +- 13.5mm de comprimento</li><li>• Kit com 10 conjuntos de Oliva e Pino</li></ul>
Material	Cobre
Peso	+1-1.2gr (peso referênte a um conjunto de Oliva e Pino)
Embalagem	50 unidades
	23754



## CHAVE TORQUE PRECISÃO 2NM A 24NM ZTTO

Característica	<ul style="list-style-type: none"><li>• Torquímetro de precisão</li><li>• Marca ztto</li><li>• Material Aço Cromo Vanádio</li><li>• Comprimento 25.4mm</li><li>• Especificação de torques 2-24nm</li><li>• Precisão +-4%</li></ul>
Material	Aço Cromo Vanádio
Kit	<ul style="list-style-type: none"><li>• 1x1/4 chave de torque</li><li>• 1 x adaptador de flor t25</li><li>• 1 x extensor adaptador haste (100mm)</li><li>• 1 x adaptador t30</li><li>• 1x2.5mm adaptador sextavado</li><li>• 1x3mm adaptador sextavado</li><li>• 1x4mm adaptador sextavado</li><li>• 1x5mm adaptador sextavado</li><li>• 1x6mm adaptador sextavado</li><li>• 1x8mm adaptador sextavado</li><li>• 1x10mm adaptador sextavado</li><li>• 1 x adaptador de cruz ph1</li><li>• 1 x adaptador de cruz ph2</li><li>• 1 x adaptador de cruz ph3</li><li>• 1 x adaptador t20</li></ul>
Peso	+792gr (Kit Completo Com Case)
Embalagem	10 unidades
	23775



FOTOS MERAMENTE ILUSTRATIVAS. AS INFORMAÇÕES/CONFIGURAÇÕES DE PRODUTOS PODERÃO SOFRER ALTERAÇÕES SEM AVISO PRÉVIO.

ENTRE EM CONTATO COM O SEU CONSULTOR OU FALE COM O NOSSO TIME DE TELEVENDAS PELO (33) 3277-3030.

## FERRAMENTA UNIVERSAL EIXO P/TORNO TQJJ01 ZTTO

Característica	<ul style="list-style-type: none"> <li>• Mordente para morsa</li> <li>• Marca ztto</li> <li>• Material Alumínio</li> <li>• Atração magnética para um melhor fixação na morsa</li> <li>• Ideal para manutenção de cubos e eixos em geral</li> <li>• Medidas (5 / 7.4 / 8 / 9 / 9.5 / 10 / 10.4 / 12 / 12.7 / 14 / 16MM)</li> </ul>
Material	Alumínio
Peso	+138gr (peso referente ao conjunto com 2 peças)
Embalagem	25 unidades

23770



## FERRAMENTA UNIVERSAL EIXO P/TORNO TQJJ02 ZTTO

Característica	<ul style="list-style-type: none"> <li>• Mordente para morsa</li> <li>• Marca ztto</li> <li>• Material Alumínio</li> <li>• Atração magnética para um melhor fixação na morsa</li> <li>• Ideal para manutenção de cubos, Shocks e eixos em geral</li> <li>• Medidas(16.6 / 17 / 18 / 18.7 / 20 / 22.2 / 23.9MM)</li> </ul>
Material	Alumínio
Peso	+172gr (peso referente ao conjunto com 2 peças)
Embalagem	25 unidades

23771



## FERRAMENTA UNIVERSAL EIXO P/TORNO TQJJ03 ZTTO

Característica	<ul style="list-style-type: none"> <li>• Mordente para morsa Universal</li> <li>• Marca ztto</li> <li>• Material Alumínio</li> <li>• Atração magnética para um melhor fixação na morsa</li> <li>• Ideal para manutenção de cubos, Shocks e eixos em geral</li> <li>• Medidas em mm (3 / 5 / 8 / 10 / 28.6)</li> <li>• Medidas em polegadas (20-9 / 25-5 / 30-12 / 36-14)</li> </ul>
Material	Alumínio
Peso	+212gr (peso referente ao conjunto com 2 peças)
Embalagem	25 unidades

23772



## KIT FERRAMENTA DE REMOÇÃO DO GANCHO PISTÃO ZTTO

Característica	<ul style="list-style-type: none"> <li>• Pinça para remover o'rings</li> <li>• Marca ztto</li> <li>• Material Aço</li> <li>• Gancho com ângulos de 0° / 45° / 90° / 110°</li> <li>• Comprimento +- 16cm</li> <li>• Ideal para remover anéis o'rings e arruelas de pressão</li> </ul>
Material	Aço
Peso	+90gr (peso referente ao kit com 4 peças)
Embalagem	25 unidades

23777





## CORTADOR MANGUEIRA HIDRÁULICA

Característica	Kit Cortador de Mangueira e Instalador de Pino da Oliva
	Cortador de Mangueira de freio hidráulico de Nylon com Lâmina de aço e Instalador de Pino da Oliva durável de alta resistência, produzido em alumínio
Material	Cortador de Nylon/ Instalador de Pino da Oliva em Alumínio e aço
Tamanho	86x59x24mm - medidas extraídas com a ferramenta fechada
Peso	163 g
Embalagem	50 peças
	19509



## CORTADOR DE TUBO AÇO

	Cortador de tubos
	Liga de aço de alta qualidade, usado para cortar espiga do garfo de bicicleta; guidão; canote; tanto em materiais de alumínio, quanto de aço ou produtos de titânio. compatível com tubo OD 6-42mm (AVISO: NÃO é indicado o uso em componentes de fibra de carbono)
Característica	
Material	Aço
Tamanho	150 x 60 mm
Peso	254 g
Embalagem	50 peças
	19510



## ALINHADOR DE GANCHEIRA

Característica	Alinhador de Gancheira
	Corpo (barra) em aço ultraresistente com acabamento cromado; compatível com ajuste em quadros de bicicletas aro 20" a 29" (incl. 700c speed & híbridas); parafuso de inserção no quadro intercambiável; maior espaço entre a ferramenta e o quadro (parafuso de inserção mais comprido), o que a torna compatível com quadros mais modernos com eixos "passantes"
Material	Aço
Tamanho	400mm
Peso	775 g
Embalagem	50 peças
	19511

FOTOS MERAMENTE ILUSTRATIVAS. AS INFORMAÇÕES/CONFIGURAÇÕES DE PRODUTOS PODERÃO SOFRER ALTERAÇÕES SEM AVISO PRÉVIO.

ENTRE EM CONTATO COM O SEU CONSULTOR OU FALE COM O NOSSO TIME DE TELEVENDAS PELO (33) 3277-3030.



## FERRAMENTA LIMPAR ROSCA PEDIVELA 9/16

**Característica** Macho limpador de rosca

Macho com rosca de 9/16 polegadas, Limpa e refaz rosca do braço do pedivela onde encaixa o pedal.  
**ATENÇÃO** - Lado esquerdo (L): a ferramenta mais longa é para o lado esquerdo  
**ATENÇÃO** - Lado direito (R): a ferramenta mais curta é para o lado direito

**Material** Aço

**Tamanho** 9/16-20hss / 9/16-20lhss

**Peso** 130 g

**Embalagem** 50 peças

19512



## PROTETOR BRAÇO PEDIVELA PT

**Característica** Protetor de Pedivela

Protetor de braço do pedivela, excelente proteção contra impactos, Incrivelmente leve, montagem rápida e fácil.

**Material** Borracha flexível (alta resistência)

**Tamanho** 43x33x18mm

**Peso** 15 g

**Embalagem** 50 peças

19513



## GUIA CABO ADAPTADOR

**Característica** Guia para conduíte

Guia para conduítes e mangueira de freios

**Material** Alumínio/Plástico

**Tamanho** 20x20.6x0.3 mm

**Peso** 2 g

**Embalagem** 100 peças

19514





## ABRAÇADEIRA PREDEDOR CONDUITE PT

Característica	Abraçadeira rígida tipo "U" para prender conduíte
Material	Plástico
Tamanho	10.5X11.2X5.7mm
Peso	4 g
Embalagem	200 peças
	19515

## PREDEDOR CONDUITE DUPLO



Característica	Prendedor de Conduíte
	Prendedor de conduíte duplo compatível com cabos de 4 e 5mm, versátil, fácil instalação, gira 360°.
Material	Plástico rígido
Tamanho	20x7.65x5.4mm
Peso	0,05 g
Embalagem	200 peças
	19516

## EIXO TRASEIRO BOOST 12X148MM



Característica	Eixo passante 12x148mm Boost
	Eixo traseiro Boost 12mm SEM bolcagem, eixo vazado, instalação com uso de chave allen 6mm, torque de aperto 9-13.5N-m
Material	Alumínio
Tamanho	comprimento total 171mm/ Diâmetro 12mm/ comprimento da rosca 19mm/ passo da Rosca 1.5 (M12 X P1.5)
Peso	39 g
Embalagem	50 peças
	19517

FOTOS MERAMENTE ILUSTRATIVAS. AS INFORMAÇÕES/CONFIGURAÇÕES DE PRODUTOS PODERÃO SOFRER ALTERAÇÕES SEM AVISO PRÉVIO.

ENTRE EM CONTATO COM O SEU CONSULTOR OU FALE COM O NOSSO TIME DE TELEVENDAS PELO (33) 3277-3030.



## EIXO DIANTEIRO BOOST 15X110MM

Característica	Eixo passante 15x110mm Boost
	Eixo dianteiro Boost 15mm, OLD 110mm, SEM bolcagem, eixo vazado, instalação com uso de chave allen 6mm, torque de aperto 9-13.5N-m/ 80-120in-lbs
Material	Alumínio
Tamanho	Comprimento total 155mm/ Diâmetro 15mm/ comprimento da rosca 13mm/ passo da Rosca 1.5 (M14 X P1.5)
Peso	56 g
Embalagem	50 peças

19518



## EIXO BLOCAGEM TRASEIRO BOOST 12X148MM

Característica	Eixo passante 12x148mm Boost
	Eixo traseiro Boost 12mm COM bolcagem vazado, instalação por Blocagem/ Alavanca com regulagem de posição.
Material	Alumínio
Tamanho	comprimento total 171mm/ Diâmetro 12mm/ comprimento da rosca 19mm/ passo da Rosca 1.5 (M12 X P1.5)
Peso	58 g
Embalagem	50 peças

19521



## FITA ANTIFURO 29"

Característica	Fita antifuro 29"
	Fita antifuro de alta resistência compatível com aros 26" / 27.5" / 29" e 700c. Diâmetro de pneus 1.5" à 2.10"
Material	Compostos de polímero de poliuretano
Tamanho	0.5 x 40mm
Peso	110 g
Embalagem	50 peças

19523





### FITA POLIPROPILENO ARO TUBELESS 10 MTX23MM MTB

Característica	Fita de vedação para aro Tubeless Fita adesiva de Polipropileno de alta resistência para vedação de aros tubeless.
Material	Polipropileno
Tamanho	10 mt x 23 mm
Peso	45 g
Embalagem	50 peças
	19525



### FITA POLIPROPILENO ARO TUBELESS 10 MTX29MM MTB

Característica	Fita de vedação para aro Tubeless Fita adesiva de Polipropileno de alta resistência para vedação de aros tubeless.
Material	Polipropileno
Tamanho	10 mt x 29 mm
Peso	54 g
Embalagem	50 peças
	19526



### FITA POLIPROPILENO ARO TUBELESS 10 MTX33MM MTB

Característica	Fita de vedação para aro Tubeless Fita adesiva de Polipropileno de alta resistência para vedação de aros tubeless.
Material	Polipropileno
Tamanho	10 mt x 33 mm
Peso	60 g
Embalagem	50 peças
	19527

FOTOS MERAMENTE ILUSTRATIVAS. AS INFORMAÇÕES/CONFIGURAÇÕES DE PRODUTOS PODERÃO SOFRER ALTERAÇÕES SEM AVISO PRÉVIO.

ENTRE EM CONTATO COM O SEU CONSULTOR OU FALE COM O NOSSO TIME DE TELEVENDAS PELO (33) 3277-3030.





## TAMPA VÁLVULA PRESTA PT

Característica	Tampa de válvula presta
Material	Alumínio
Tamanho	16x7mm
Peso	2 g
Embalagem	50 peças

19528



## INJETOR SELANTE

Característica	Injetor de selante 60ml - Seringa
Material	Plástico/Borracha
Tamanho	151.5x31.3mm
Peso	35 g
Embalagem	50 peças

19529



## ADESIVO PROTETOR QUADRO

Característica	Adesivo protetor de quadro
Material	PVC FLEXÍVEL de 500 microns
Peso	84 g
Embalagem	50 peças

19530

FOTOS MERAMENTE ILUSTRATIVAS. AS INFORMAÇÕES/CONFIGURAÇÕES DE PRODUTOS PODERÃO SOFRER ALTERAÇÕES SEM AVISO PRÉVIO.

ENTRE EM CONTATO COM O SEU CONSULTOR OU FALE COM O NOSSO TIME DE TELEVENDAS PELO (33) 3277-3030.







## ABRAÇADEIRA CÂMBIO DIANTEIRO

**Característica** Abraçadeira de câmbio

Adaptador de câmbio dianteiro suspenso de 34,9mm. Abraçadeira feita exclusivamente para câmbios dianteiros braze-on, ou câmbios que não possuem abraçadeiras.

**Material** Alumínio

**Tamanho** 61x12mm

**Peso** 21 g

**Embalagem** 50 peças

19548



## SUPORTE ADAPTADOR GPS MODELO 01

**Característica** Suporte adaptador para GPS, câmera ou lanterna.

Versátil e com várias possibilidades de regulagem. Pode ser instalado em guidões com diâmetro de 31,8 mm ou 25,4 mm.

**Material** Liga de alumínio CNC

**Tamanho** 115 mm x 54 mm

**Peso** 70 g

**Embalagem** 50 peças

19531



## SUPORTE ADAPTADOR GPS MODELO 02

**Característica** Suporte adaptador para GPS, câmera ou lanterna.

Versátil e com várias possibilidades de regulagem. Pode ser instalado em guidões com diâmetro de 31,8 mm ou 25,4 mm.

**Material** Liga de alumínio CNC

**Tamanho** 128 mm x 55 mm

**Peso** 75 g

**Embalagem** 50 peças

19533



## SUPORTE ADAPTADOR GPS MODELO 03

Característica	Suporte adaptador para GPS, câmera ou lanterna.
	Versátil e com várias possibilidades de regulagem.
Material	Liga de alumínio CNC
Tamanho	167 mm x 37 mm
Peso	85 g
Embalagem	50 peças
	19535



## SUPORTE ADAPTADOR GPS MODELO 04

Característica	Suporte adaptador para GPS
	Adaptador Universal Para Montagem GARMIN - Fixado com fita dupla face 3M
Material	Plástico
Tamanho	40x40mm
Peso	10 g
Embalagem	50 peças
	19536



## SUPORTE CO2 PT

Característica	Suporte para CO2
Material	Alumínio 6067 T6
Tamanho	83X72mm - Distância dos furos, aproximadamente 64mm
Peso	21 g
Embalagem	50 peças
	19543





## ADAPTADOR SUPORTE CARAMANHOLA DUPLO PT

Característica	Suporte Duplo para caramanhola
Material	Alumínio
Tamanho	75.8X32.6X3.3mm - Distância dos furos, aproximadamente 64mm
Peso	18 g
Embalagem	50 peças

19544



## TENSIONADOR DE CORRENTE PT

Característica	Tensionador de corrente
	Tensionador de corrente de bicicleta de velocidade única, equipado com roldana de alumínio com rolamento. Compatível com COG's de 13-23T
Material	Alumínio
Tamanho	110X24.5X10mm
Peso	62 g
Embalagem	50 peças

19545

FOTOS MERAMENTE ILUSTRATIVAS. AS INFORMAÇÕES/CONFIGURAÇÕES DE PRODUTOS PODERÃO SOFRER ALTERAÇÕES SEM AVISO PRÉVIO.

ENTRE EM CONTATO COM O SEU CONSULTOR OU FALE COM O NOSSO TIME DE TELEVENDAS PELO (33) 3277-3030.



## ROLDANA DE CÂMBIO 12T

Característica	Roldana de câmbio 12T    Liga de alumínio de alta resistência   Rolamento de cerâmica   Polia Jockey Wheel
Material	Liga de alumínio CNC 7075
Tamanho	50 mm x 3 mm - Suporte do rolamento 10mm
Peso	8 g
Embalagem	50 peças
	19546



## ROLDANA DE CÂMBIO 13T

Característica	Roldana de câmbio 13T    Liga de alumínio de alta resistência   Rolamento de cerâmica   Polia Jockey Wheel
Material	Liga de alumínio CNC 7075
Tamanho	51 mm x 1,7 mm - Suporte do rolamento 9,6 mm
Peso	9 g
Embalagem	50 peças
	19547



## REPARO APERTO CASSETE 11V - ZTTO

Característica	Porca de aperto do cassete ztto Alumínio 7075 Cor grafite Compatível com cog de 11 dentes Padrão do free hub standard Aperto máximo de 40nm
Material	Alumínio
Peso	7 g
Embalagem	100 peças
	19494



Grupo  
**pblk**<sup>®</sup>  
 A vida pede liberdade

## PRÓBIKE



**BOLSA DE SELIM VELO**

MARCA	Próbike
CARACTERÍSTICA	Expansível   Confeccionada em Nylon de alta performance   Estruturada com plástico rígido de 2 mm   Zíperes invisíveis de qualidade   A prova d'água   Faixa e logo refletiva 3M   Fixação central por fitas e fivelas de nylon   Fixação por velcros no canote do selim   Abertura de 180%   Bolso telado interno para ferramentas   Fita frontal para luz estroboscópica

TAMANHO	L: 0,110mm x A: 0,140mm x P: 0,170mm (Medidas após expandida: L: 0,110mm x A: 0,140mm x P: 0,210mm)
---------	---

EMBALAGEM	30 peças
	20061



**BOLSA DE SELIM M2**

MARCA	Próbike
CARACTERÍSTICA	Confeccionada em exclusivo tecido emborrachado   Resistente a água   Zíperes invisíveis de qualidade   Logo refletiva 3M   Fixação central por fitas e fivelas de nylon   Fixação por fitas de contato no canote do selim   Abertura de 180%

CAPACIDADE	0,280 litros
PESO	102g (informado pelo fabricante)

TAMANHO	L: 120mm x A: 95mm x P: 150mm
---------	-------------------------------

EMBALAGEM	30 peças
	20063



**BOLSA DE SELIM BIKE PRÓ**

MARCA	Próbike
CARACTERÍSTICA	Confeccionada em nylon ripstop de alta performance   Revestimento inferior emborrachado (Resistente a água)   Zíper invisível de alta qualidade   Logo e fita refletiva 3M   Fixação dupla por fitas de aderência e fivelas de nylon   Fixação no canote do selim   Fita frontal para luz estroboscópica

CAPACIDADE	0,220 litros
PESO	78g (informado pelo fabricante)

TAMANHO	L: 60mm x A: 70mm x P: 140mm
---------	------------------------------

EMBALAGEM	30 peças
	20074

FOTOS MERAMENTE ILUSTRATIVAS. AS INFORMAÇÕES/CONFIGURAÇÕES DE PRODUTOS PODERÃO SOFRER ALTERAÇÕES SEM AVISO PRÉVIO.

ENTRE EM CONTATO COM O SEU CONSULTOR OU FALE COM O NOSSO TIME DE TELEVENDAS PELO (33) 3277-3030.



## BOLSA DE SELIM MOUNTAIN

MARCA	Próbike
CARACTERÍSTICA	Expansível   Confeccionada em nylon de alta performance   Exclusivo zíper impermeável com cursor duplo invertido   Estruturada com plástico rígido de 2 mm   A prova d'água   Faixa e logo refletiva 3M   Fixação central por fitas e fivelas de nylon   Fixação por fita de contato de alta aderência no canote do selim   Abertura de 90%   Bolso telado interno para ferramentas   Fita frontal para luz estroboscópica.
TAMANHO	L: 90mm x A: 110mm x P: 150mm
EMBALAGEM	30 peças
	<b>20090</b>



## BOLSA DE SELIM SQUEEZE

MARCA	Próbike
CARACTERÍSTICA	Confeccionada em nylon de alta performance   Exclusivo zíper com cursor duplo invertido   Estruturada com plástico rígido de 2 mm   A prova d'água   Desenho exclusivo com material em fibra de carbono   Logo refletiva 3M frontal   Fixação central por fitas de contato por alta aderência   Fixação por fita de contato de alta aderência no canote do selim   Bolso interno para ferramentas   Fita frontal para luz estroboscópica
CAPACIDADE	1,200 litros
PESO	210g (informado pelo fabricante)
TAMANHO	L: 105mm x A: 240mm x P: 96mm
EMBALAGEM	30 peças
	<b>20097</b>



## BOLSA DE GUIDÃO PARA CELULAR

MARCA	Próbike
CARACTERÍSTICA	Confeccionada em Nylon de alta performance   Compartimento de grande capacidade   Estruturada em espuma acrílica de 6 mm   Toda forrada e acolchoada   Sistema de fixação por fita de contato de alta aderência   Tampa com exclusivo material touch-screen   Fechamento por zíper invisível e duplo cursor
CAPACIDADE	0,900 litros
PESO	138g (informado pelo fabricante)
TAMANHO	L: 120 mm x P: 180 mm x A: 90 mm
EMBALAGEM	50 peças
	<b>20065</b>



## BOLSA DE QUADRO PARA CELULAR UNIVERSAL

MARCA	Próbike
CARACTERÍSTICA	Confeccionada em Nylon de alta performance   Compartimento principal de grande capacidade   Estruturada em espuma acrílica de 6 mm   Toda forrada e acolchoada   Pequeno bolso interno telado   Sistema de fixação com fitas   A prova d'água   Faixas laterais e logo refletivas 3M   Tampa com exclusivo material touch-screen   Fechamento por zíper invisível e duplo cursor
EMBALAGEM	50 peças
	<b>20079</b>



## BRACELETE PARA CELULAR

MARCA	Próbike
CARACTERÍSTICA	Touch screen   Fabricado em material super flexível   Confortável e leve   Pode ser usado em qualquer um dos braços
EMBALAGEM	50 peças
	<b>20076</b>



## BOLSA DE CELULAR PARA STRAVA

MARCA	Próbike
CARACTERÍSTICA	Confeccionada em exclusivo material Plush   Painel Touch Screen   Compatível com todas as mesas   Sistema de fixação por exclusivo fita de contato de alta aderência elástico   Segura e de fácil instalação   Moldada totalmente ao celular substituindo um suporte   Proteção segura contra o pó e chuva fina   Espuma traseira para proteger o celular dos choques
TAMANHO	L: 90mm x A: 170mm x P: 5mm
EMBALAGEM	50 peças
	<b>20092</b>

FOTOS MERAMENTE ILUSTRATIVAS. AS INFORMAÇÕES/CONFIGURAÇÕES DE PRODUTOS PODERÃO SOFRER ALTERAÇÕES SEM AVISO PRÉVIO.

ENTRE EM CONTATO COM O SEU CONSULTOR OU FALE COM O NOSSO TIME DE TELEVENDAS PELO (33) 3277-3030.



## MALA BIKE ARO 29"

MARCA	Próbike
CARACTERÍSTICA	Possui 3 divisões internas para as rodas e quadro   Confeccionada em nylon de alta resistência   Fundo removível em E.V.A. de 4 mm para maior proteção   A prova d'água   Fechamento por zíperes de alta qualidade   Reforço interno em velcro nas divisórias   Acompanha bolsa/mochila para transporte   Alças de mão e tiracolo
TAMANHO	L: 1.600mm x A: 900mm x 300mm
EMBALAGEM	1 peça

20077



## FITA WRAP VELCRO PARA CAMARA DE AR

MARCA	Próbike
CARACTERÍSTICA	Confeccionada em Fita Nylon de alta performance   Estruturada com plástico rígido de 2 mm   Fita de contato de alta aderência de alta de qualidade   Logo refletiva 3M   Fixação central por fitas e fivelas de nylon   Suporte extra em elásticos para maior segurança   Não acompanha a camara e a bomba
TAMANHO	L: 50mm x A: 50mm x P: 430mm
EMBALAGEM	10 peças

20094



## PROTECTOR DE QUADRO CONVENCIONAL

MARCA	Próbike
CARACTERÍSTICA	Confeccionado material emborrachado de alta densidade   Desenho em alto relevo para maior durabilidade   Fixado com exclusiva fita dupla face de alta aderência   Acompanha o desenho do quadro   Tamanho universal   Não desgasta os quadros de carbono   Lavável   Fechamento por tirantes plásticos (acompanha o produto)   O mais leve do mercado   Sistema de instalação rápida
EMBALAGEM	50 peças

20072



## PROTECTOR DE QUADRO ARO 29

MARCA	Próbike
CARACTERÍSTICA	Confeccionado em exclusivo material de alta densidade   Estampa em silk de alta densidade lavável   Fechamento por fita de contato de alta aderência   Costura em zig-zag para maior durabilidade   Sistema de instalação rápida   Acompanha embalagem exclusiva
EMBALAGEM	50 peças

20073



## PROTECTOR DE QUADRO ELITE



MARCA	Próbike
CARACTERÍSTICA	Confeccionado material emborrachado de alta densidade   Desenho em alto relevo para maior durabilidade   Fixado com exclusiva fita dupla face de alta aderência   Acompanha o desenho do quadro   Tamanho universal   Não desgasta os quadros de carbono   Lavável   Fechamento por 3 tirantes plásticos (acompanha o produto)   O mais leve do mercado   Sistema de instalação rápida   Pode ser re-utilizado várias vezes
EMBALAGEM	50 peças
	20091



## COLETE REFLETIVO

MARCA	Próbike
CARACTERÍSTICA	Visibilidade de 1,5 km   Bolso na parte traseira (1)   Confeccionado em Tecido Mesh super ventilada   Leve e prática   Tamanho único
TAMAMHO	L: 340mm x A: 430mm
EMBALAGEM	10 peças

20067



## COLETE CORTA VENTO REFLETIVO

MARCA	Próbike
CARACTERÍSTICA	Confeccionado em NY70 com hidropelente   TelaMesh super ventilada na parte traseira   3 bolsos na parte traseira   Refletivos com visibilidade de 1 km   Zíper de alta qualidade   Elástico no barrado
EMBALAGEM	10 peças

P 20068  
M 20069  
G 20070  
GG 20071



## Colete Refletivo Night Race

MARCA	Próbike
CARACTERÍSTICA	Confeccionado em elastano e refletivo 3M   Visibilidade de 3 km   leve e prático   Tamanho único   Elásticos de fixação lateral
EMBALAGEM	10 peças

20075



GRUPO JPP

# Grupo pblk

A vida pede liberdade

**MADE IN BRASIL**



**BOLSA DE SELIM AERO BIG**

MARCA	Made in Brasil
CARACTERÍSTICA	Confeccionada em Nylon 600D   Fxação central por fitas e fivelas de nylon   Nova fixação por fita de contato no canote do selim   Fita para fixação de lanterna   Abertura por zíper
CAPACIDADE	0,980 litros
PESO	83g (informado pelo fabricante)
TAMANHO	L: 110mm x A: 100mm x P: 170mm
EMBALAGEM	30 peças
	<b>20096</b>



**BOLSA DE SELIM M1**

MARCA	Made in Brasil
CARACTERÍSTICA	Confeccionada em Nylon 600D   Detalhe refletivo na fita frontal e na logo   Nova fixação central por fitas e fivelas de nylon   Nova fixação por fita de fixação por contato no canote do selim   Estruturada com plástico rígido de 2 mm   Fita frontal para luz estroboscópica   Abertura por zíper
CAPACIDADE	0,280 litros
PESO	113g (informado pelo fabricante)
TAMANHO	L: 85mm x A: 90mm x P: 120mm
EMBALAGEM	30 peças
	<b>20078</b>



**BOLSA DE QUADRO PARA CELULAR GRANDE**

MARCA	Made in Brasil
CARACTERÍSTICA	Confeccionada em Poliéster 600D   Compartimento principal de grande capacidade   Sistema de fixação com fitas de contato de alta aderência   Resistente a água   Tampa com exclusivo material touch-screen   Fechamento por zíperes   Painel Toothscreen   Saída para fone de ouvido
CAPACIDADE	0,980 litros
EMBALAGEM	50 peças
	<b>20064</b>



FOTOS MERAMENTE ILUSTRATIVAS. AS INFORMAÇÕES/CONFIGURAÇÕES DE PRODUTOS PODERÃO SOFRER ALTERAÇÕES SEM AVISO PRÉVIO.

ENTRE EM CONTATO COM O SEU CONSULTOR OU FALE COM O NOSSO TIME DE TELEVENDAS PELO (33) 3277-3030.



## BOLSA DE SELIM COMBAT

MARCA	Made in Brasil
CARACTERÍSTICA	Confeccionada em nylon de alta performance   Revestimento inferior emborrachado   Resistente a água   Zíper invisível de alta qualidade   Fixação central por fita de aderência e fivela de nylon   Fixação no canote do selim   Fita frontal para luz estroboscópica
CAPACIDADE	0,320 litros
TAMANHO	L: 65mm x A: 70mm x P: 150mm
EMBALAGEM	30 peças

20082

20083

20084

20085



## BOLSA DE SELIM COMBAT PLUS

MARCA	Made in Brasil
CARACTERÍSTICA	Confeccionada em nylon ripstop de alta performance   Revestimento inferior emborrachado   Resistente a água   Zíper invisível de alta qualidade   Logo refletiva 3M   Fixação central por fita e fivela de nylon   Fixação no canote do selim   Fita frontal para luz estroboscópica

CAPACIDADE 0,430 litros

TAMANHO L: 80mm x A: 90mm x P: 160mm

EMBALAGEM 30 peças

20086

20087

20088

20089

Grupo  
**pblk**  
 A vida pede liberdade

# HIDRAT-PRÓ



**REFIL/RESERVATÓRIO  
 BIPARTIDO 1,2 LITROS**



**REFIL/RESERVATÓRIO  
 BIPARTIDO 2,5 LITROS**



**BICO DE SUÇÃO DE  
 SILICONE**



MARCA Hydrat Pró

CARACTERÍSTICA Confeccionado em composto atóxico de extrema resistência | Muito mais qualidade pelo menor preço | É compatível com todas as mochilas de hidratação do mercado | Inodoro. Não altera o sabor dos líquidos | BPA Free - Material não tóxico | Bico dosador duplo anti-respingo siliconado | Mangueira dupla siliconada de 90cm atóxica de 9,3mm | Torneira dupla abre-fecha muito mais segura | Sistema deslizante que facilita a limpeza e abastecimento | Reservatório de 1 litro de um lado e 200ml do outro

TAMANHO 31 x 18 cm

EMBALAGEM 25 peças

20080

MARCA Hydrat Pró

CARACTERÍSTICA Confeccionado em material atóxico de extrema resistência | Muito mais qualidade pelo menor preço | É compatível com todas as mochilas de hidratação do mercado | Inodoro. Não altera o sabor dos líquidos | BPA Free | Material não tóxico | Novo Bico dosador anti-respingo em silicone | Mangueira dupla siliconada de 95cm atóxica de 9,3mm | Torneira dupla abre-fecha muito mais segura | Sistema deslizante que facilita a limpeza e abastecimento | Reservatório de 2,5 litros de capacidade total podendo ser bipartido em qualquer capacidade

TAMANHO 41 x 18 cm

EMBALAGEM 25 peças

20081

MARCA Hydrat Pró

CARACTERÍSTICA BPA free | Confeccionada em Silicone ultra macio, inodoro e atóxico | Embalada assepticamente | Encaixa em qualquer reservatório | Fácil de limpar | Rápida liberação de água | Processo de fabricação com sistema de gestão da qualidade de acordo com RDC-59

EMBALAGEM 100 peças

20095

FOTOS MERAMENTE ILUSTRATIVAS. AS INFORMAÇÕES/CONFIGURAÇÕES DE PRODUTOS PODERÃO SOFRER ALTERAÇÕES SEM AVISO PRÉVIO.

ENTRE EM CONTATO COM O SEU CONSULTOR OU FALE COM O NOSSO TIME DE TELEVENDAS PELO (33) 3277-3030.

# SR

SELLE ROYAL



CYCLE THE WORLD IN COMFORT



### DESCANSO LATERAL A20 ZINCADO

Material	Aço
Medida	0,019m <sup>3</sup>
Tamanho	270mmx11mmx18mm
Peso	155g
Embalagem	120 peças

20705



### DESCANSO LATERAL A20 ZINCADO PARA CAMBIO

Material	Aço
Medida	0,019m <sup>3</sup>
Tamanho	270mmx11mmx18mm
Peso	149g
Embalagem	120 peças

20708



### PEDAL BICOLOR EXPORT 9/16 S/ESF - CINZA

Característica	BICICLETAS A24 a A29, MTB E PASSEIO. Os pedais METALCICLO possuem a Base injetada em PP copolímero, refletores de poliestireno e eixo conformado com arame de aço.
Material	Copolímero
Medida	0,028m <sup>3</sup>
Tamanho	96mmx30mmx70mm
Peso	161,60g
Embalagem	44 peças

20709



SELLE ROYAL



#### PEDAL FREESTYLE PP 1/2 S/ESF - PRETO

Característica	BICICLETAS A24 a A29, MTB E PASSEIO. Os pedais METALCICLO possuem a Base injetada em PP copolímero, refletores de poliestireno e eixo conformado com arame de aço.
Material	Copolímero
Medida	0,028m <sup>3</sup>
Tamanho	98mmx25mmx89mm
Peso	149,50g
Embalagem	30 peças

20710



#### PEDAL FREESTYLE PP 9/16 S/ESF - PRETO

Característica	BICICLETAS A24 a A29, MTB E PASSEIO. Os pedais METALCICLO possuem a Base injetada em PP copolímero, refletores de poliestireno e eixo conformado com arame de aço.
Material	Copolímero
Medida	0,028m <sup>3</sup>
Tamanho	98mmx25mmx88,5mm
Peso	156,20g
Embalagem	30 peças

20711



#### PEDAL MTB 1/2 S/ESF - PRETO

Característica	BICICLETAS A24 a A29, MTB E PASSEIO. Os pedais METALCICLO possuem a Base injetada em PP copolímero, refletores de poliestireno e eixo conformado com arame de aço.
Material	Copolímero
Medida	0,028m <sup>3</sup>
Tamanho	98mmx25mmx75mm
Peso	130g
Embalagem	40 peças

20712

FOTOS MERAMENTE ILUSTRATIVAS. AS INFORMAÇÕES/CONFIGURAÇÕES DE PRODUTOS PODERÃO SOFRER ALTERAÇÕES SEM AVISO PRÉVIO.

ENTRE EM CONTATO COM O SEU CONSULTOR OU FALE COM O NOSSO TIME DE TELEVENDAS PELO (33) 3277-3030.



SELLE ROYAL



#### PEDAL BICOLOR EXPORT 9/16 S/ESF - VERMELHO

Característica	BICICLETAS A24 a A29, MTB E PASSEIO. Os pedais METALCICLO possuem a Base injetada em PP copolímero, refletores de poliestireno e eixo conformado com arame de aço.
Material	Copolímero
Medida	0,028m <sup>3</sup>
Tamanho	98mmx30mmx72mm
Peso	161,60g
Embalagem	44 peças

20713



#### PEDAL BICOLOR EXPORT 1/2 S/ESF - PRETO

Característica	BICICLETAS A24 a A29, MTB E PASSEIO. Os pedais METALCICLO possuem a Base injetada em PP copolímero, refletores de poliestireno e eixo conformado com arame de aço.
Material	Copolímero
Medida	0,028m <sup>3</sup>
Tamanho	98mmx30mmx72mm
Peso	158g
Embalagem	44 peças

20714



#### PEDAL FREE SPORT 9/16 S/ESF

Característica	BICICLETAS A24 a A29, MTB E PASSEIO. Design moderno, perfil fino e base larga. Super resistente. Com cravos maiores que ajudam na aderência. O pedal plataforma FREE SPORT é a resposta certa para seus desafios.
Material	Copolímero
Medida	0,028m <sup>3</sup>
Tamanho	95mmx21mmx101mm
Peso	290,66g
Embalagem	30 peças

20715

FOTOS MERAMENTE ILUSTRATIVAS. AS INFORMAÇÕES/CONFIGURAÇÕES DE PRODUTOS PODERÃO SOFRER ALTERAÇÕES SEM AVISO PRÉVIO.

ENTRE EM CONTATO COM O SEU CONSULTOR OU FALE COM O NOSSO TIME DE TELEVENDAS PELO (33) 3277-3030.

# SR

SELLE ROYAL



## PEDAL FREESTYLE PP 1/2 S/ESF - PRETO

Característica	Design moderno, perfil fino e base larga 93x102x27, super resistente! Com cravos maiores que ajudam na aderência, o novo pedal plataforma FREE SPORT é a resposta certa para seus desafios.
Material	Copolímero
Medida	0,028m³
Tamanho	95mmx21mmx101mm
Peso	290g
Embalagem	30 peças

20716



## PEDAL MIRIM 1/2 S/ESF PRETO

Característica	BICICLETAS A16 a A20, INFANTO JUVENIL. Os pedais METALCICLO possuem a Base injetada em PP copolímero, refletores de poliestireno e eixo conformado com arame de aço.
Material	Copolímero
Medida	0,028m³
Tamanho	83mmx21mmx61,5mm
Peso	230g
Embalagem	60 peças

20722



## PEDAL MOUNTAIN BARRA 1/2 S/ESF - PRETO

Característica	BICICLETAS A24 a A29, MTB E PASSEIO. Os pedais METALCICLO possuem a Base injetada em PP copolímero, refletores de poliestireno e eixo conformado com arame de aço.
Material	Copolímero
Medida	0,028m³
Tamanho	96mmx24mmx68mm
Peso	123,60g
Embalagem	48 peças

20724

FOTOS MERAMENTE ILUSTRATIVAS. AS INFORMAÇÕES/CONFIGURAÇÕES DE PRODUTOS PODERÃO SOFRER ALTERAÇÕES SEM AVISO PRÉVIO.

ENTRE EM CONTATO COM O SEU CONSULTOR OU FALE COM O NOSSO TIME DE TELEVENDAS PELO (33) 3277-3030.



# SR

SELLE ROYAL



### PEDAL MTB 9/16 S/ESF - PRETO

Característica	BICICLETAS A24 a A29, MTB E PASSEIO. Os pedais METALCICLO possuem a Base injetada em PP copolímero, refletores de poliestireno e eixo conformado com arame de aço.
Material	Copolímero
Medida	0,028m <sup>3</sup>
Tamanho	98mmx25mmx75mm
Peso	132g
Embalagem	40 peças

20725



### PEDAL MTB FASHION 9/16 S/ESF - PRETO

Característica	BICICLETAS A24 a A29, MTB E PASSEIO. Os pedais METALCICLO possuem a Base injetada em PP copolímero, refletores de poliestireno e eixo conformado com arame de aço.
Material	Copolímero
Medida	0,028m <sup>3</sup>
Tamanho	98mmx26mmx75mm
Peso	129,82g
Embalagem	44 peças

20726



### PEDAL TREKKING 9/16 S/ESF

Característica	BICICLETAS A24 a A29, MTB E PASSEIO. Os pedais METALCICLO possuem a Base injetada em PP copolímero, refletores de poliestireno e eixo conformado com arame de aço.
Material	Copolímero
Medida	0,028m <sup>3</sup>
Tamanho	98mmx20mmx78mm
Peso	145,68g
Embalagem	44 peças

20728

FOTOS MERAMENTE ILUSTRATIVAS. AS INFORMAÇÕES/CONFIGURAÇÕES DE PRODUTOS PODERÃO SOFRER ALTERAÇÕES SEM AVISO PRÉVIO.

ENTRE EM CONTATO COM O SEU CONSULTOR OU FALE COM O NOSSO TIME DE TELEVENDAS PELO (33) 3277-3030.



SELLE ROYAL



#### PEDIVELA MONOBLOCO 115MM CROMADO

Característica	Com qualidade e tradição que você já conhece, a Pedivela Metalciclo possui um pino de arraste projetado para resistir a fadiga. Seu perfil plano faz com que o material fique simétrico e mais resistente, revestido com o mais moderno processo de cromo Trivalente, tornando todo o processo ecologicamente correto.
Material	Arame e Aço
Medida	0,009m <sup>3</sup>
Tamanho	115mmx13mmx140mm
Peso	0,669g
Embalagem	20 peças

20729



#### PEDIVELA MONOBLOCO 140MM CROMADO

Característica	Com qualidade e tradição que você já conhece, a Pedivela Metalciclo possui um pino de arraste projetado para resistir a fadiga. Seu perfil plano faz com que o material fique simétrico e mais resistente, revestido com o mais moderno processo de cromo Trivalente, tornando todo o processo ecologicamente correto.
Material	Arame e Aço
Medida	0,011m <sup>3</sup>
Tamanho	140mmx13mmx140mm
Peso	0,745g
Embalagem	20 peças

20730



#### PEDIVELA MONOBLOCO 165MM CROMADO

Característica	Com qualidade e tradição que você já conhece, o Pedivela Metalciclo possui um pino de arraste projetado para aguentar a fadiga. Seu perfil plano faz com que o material fique simétrico e mais resistente, revestido com o mais moderno processo de cromo Trivalente, tornando todo o processo ecologicamente correto.
Material	Arame e Aço
Medida	0,012m <sup>3</sup>
Tamanho	165mmx13mmx140mm
Peso	0,85g
Embalagem	20 peças

20731

FOTOS MERAMENTE ILUSTRATIVAS. AS INFORMAÇÕES/CONFIGURAÇÕES DE PRODUTOS PODERÃO SOFRER ALTERAÇÕES SEM AVISO PRÉVIO.

ENTRE EM CONTATO COM O SEU CONSULTOR OU FALE COM O NOSSO TIME DE TELEVENDAS PELO (33) 3277-3030.



SELLE ROYAL



#### SELIM SELLE ROYAL NEW CITY GEL

Característica	Trilhos em aço. Sistema de amortecimento: Elastômero Base em polipropileno extremamente resistente, espuma expandida, Royal Gel e cobertura de laminado de pvc. Bike de passeio e urbanas   ciclistas que buscam conforto.
Material	Royalgel
Medida	0,081m³
Tamanho	252mmx114mmx195mm
Peso	771g
Embalagem	15 peças

20732



#### SELIM SELLE ROYAL NEW MOLISE PASSEIO GEL

Característica	Trilhos em aço. Base em polipropileno extremamente resistente, espuma expandida, Royal Gel e cobertura de laminado de pvc. Bike de passeio e urbanas   ciclistas que buscam conforto.
Material	Royalgel
Medida	0,081m³
Tamanho	252mmx81mmx204mm
Peso	542g
Embalagem	15 peças

20734



#### SELIM SELLE ROYAL NEW VIALE GEL COM MOLA

Característica	Trilhos em aço. 2 molas acopladas ao trilho para absorção de impacto. Base em polipropileno extremamente resistente, espuma expandida, Royal Gel e cobertura de laminado de pvc. Bike de passeio e urbanas   ciclistas que buscam conforto.
Material	Royalgel
Medida	0,081m³
Tamanho	274mmx108mmx175mm
Peso	633g
Embalagem	15 peças

20737

FOTOS MERAMENTE ILUSTRATIVAS. AS INFORMAÇÕES/CONFIGURAÇÕES DE PRODUTOS PODERÃO SOFRER ALTERAÇÕES SEM AVISO PRÉVIO.

ENTRE EM CONTATO COM O SEU CONSULTOR OU FALE COM O NOSSO TIME DE TELEVENDAS PELO (33) 3277-3030.

# SR

## SELLE ROYAL



### SELIM CITY BIKE PRETO COM MOLAS COM CARRINHO

Característica	Base em polipropileno extremamente resistente, espuma expandida e capa de laminado de PVC. Trilhos em aço. 2 molas acopladas ao trilho para absorção de impacto Carrinho em aço zincado. Bike de passeio e urbanas   ciclistas que buscam conforto.
Material	RVS
Medida	0,081m³
Tamanho	260mmx105mmx215mm
Peso	650g
Embalagem	20 peças

20743



### SELIM LOOKIN ATHLETIC GEL

Característica	3D SKINGEL: O Royalgel™ é colocado estrategicamente de acordo com as necessidades anatômicas do ciclista, resultando em um selim mais leve, enquanto mantém a redução da pressão na área perineal e isquiática em até 40%. DOUBLE-COVER: Um material de dupla camada aplicado nas laterais do selim para dobrar a resistência contra impactos e abrasões. FLEXITE SYSTEM: Através do Flexite System, a base do selim torna-se flexível e confortável. Esta construção garante uma flexibilidade superior e uma maior absorção de impactos durante a pedalada. Bike MTB Aro de 26 a 29.
Material	Royalgel
Medida	0,044m³
Tamanho	267mmx64mmx150mm
Peso	542,94g
Embalagem	12 peças

20746



### SELIM LOOKIN MODERATE GEL

Característica	3D SKINGEL: O Royalgel™ é colocado estrategicamente de acordo com as necessidades anatômicas do ciclista, resultando em um selim mais leve, enquanto mantém a redução da pressão na área perineal e isquiática em até 40%. DOUBLE-COVER: Um material de dupla camada aplicado nas laterais do selim para dobrar a resistência contra impactos e abrasões. FLEXITE SYSTEM: Através do Flexite System, a base do selim torna-se flexível e confortável. Esta construção garante uma flexibilidade superior e uma maior absorção de impactos durante a pedalada. Bike de passeio e urbanas   ciclistas que buscam conforto.
Material	Royalgel
Medida	0,044m³
Tamanho	280mmx65mmx180mm
Peso	598,83g
Embalagem	10 peças

20747

FOTOS MERAMENTE ILUSTRATIVAS. AS INFORMAÇÕES/CONFIGURAÇÕES DE PRODUTOS PODERÃO SOFRER ALTERAÇÕES SEM AVISO PRÉVIO.

ENTRE EM CONTATO COM O SEU CONSULTOR OU FALE COM O NOSSO TIME DE TELEVENDAS PELO (33) 3277-3030.

# SR

## SELLE ROYAL



### SELIM LOOKIN RELAXED GEL

**Característica** Trilhos em aço. Sistema de amortecimento: Elastômero. 3D SKINGEL: O Royalgel™ é colocado estrategicamente de acordo com as necessidades anatômicas do ciclista, resultando em um selim mais leve, enquanto mantém a redução da pressão na área perineal e isquiática em até 40%. DOUBLE-COVER: Um material de dupla camada aplicado nas laterais do selim para dobrar a resistência contra impactos e abrasões. FLEXITE SYSTEM: Através do Flexite System, a base do selim torna-se flexível e confortável. Esta construção garante uma flexibilidade superior e uma maior absorção de impactos durante a pedalada. Bike de passeio e urbanas | ciclistas que buscam conforto.

**Material** Royalgel  
**Medida** 0,044m<sup>3</sup>  
**Tamanho** 260mmx76mmx255mm  
**Peso** 0,7445g  
**Embalagem** 6 peças

20748



### SELIM MACH 2 RVS PRETO SEM CARRINHO

**Característica** Base em polipropileno extremamente resistente, espuma expandida e capa de laminado de PVC. Trilhos em aço. Bike de passeio e urbanas | ciclistas que buscam conforto. O novo Mach 2 traz um design revolucionário combinando conforto e performance em um selim altamente refinado.

**Material** RVS  
**Medida** 0,081m<sup>3</sup>  
**Tamanho** 267mmx61mmx140mm  
**Peso** 327,50g  
**Embalagem** 32 peças

20749



### SELIM MIRIM VERMELHO SILK "ARANHA BRANCO/ AZUL" COM CARRINHO

**Característica** Base em polipropileno extremamente resistente, espuma expandida e capa de laminado de PVC. Trilhos em aço. Carrinho em aço zincado. Bicletas aro 12, 14, 16.

**Material** RVS  
**Medida** 0,028m<sup>3</sup>  
**Tamanho** 212mmx56mmx142mm  
**Peso** 265,55g  
**Embalagem** 20 peças

20752

FOTOS MERAMENTE ILUSTRATIVAS. AS INFORMAÇÕES/CONFIGURAÇÕES DE PRODUTOS PODERÃO SOFRER ALTERAÇÕES SEM AVISO PRÉVIO.

ENTRE EM CONTATO COM O SEU CONSULTOR OU FALE COM O NOSSO TIME DE TELEVENDAS PELO (33) 3277-3030.

# SR

## SELLE ROYAL



### SELIM MIRIM AZUL SILK "VELOX PRETO/VERMELHO" + CANOTE 200MM

Característica	Base em polipropileno extremamente resistente, espuma expandida e capa de laminado de PVC. Bicicletas aro 12, 14, 16.
Material	RVS
Medida	0,028m <sup>3</sup>
Tamanho	212mmx216mmx142mm
Peso	279g
Embalagem	12 peças

20753



### SELIM PVC BARRA CIRCULAR COM MOLAS - PRETO

Característica	Trilhos em aço. 2 molas acopladas ao trilho para absorção de impacto. Base em polipropileno extremamente resistente, espuma expandida e capa de PVC. Bicicletas Aro 12, 14, 16.
Material	PVC
Medida	0,081m <sup>3</sup>
Tamanho	258mmx118mmx221mm
Peso	748g
Embalagem	18 peças

20757



### SELIM PVC MINI TOY CANOTE 7/8" 190MM - PRETO

Característica	Base em polipropileno extremamente resistente, espuma expandida e capa de PVC. Bicicletas Aro 12, 14, 16.
Material	PVC
Medida	0,081m <sup>3</sup>
Tamanho	224mmx180mmx127mm
Peso	319g
Embalagem	24 peças

20759

FOTOS MERAMENTE ILUSTRATIVAS. AS INFORMAÇÕES/CONFIGURAÇÕES DE PRODUTOS PODERÃO SOFRER ALTERAÇÕES SEM AVISO PRÉVIO.

ENTRE EM CONTATO COM O SEU CONSULTOR OU FALE COM O NOSSO TIME DE TELEVENDAS PELO (33) 3277-3030.

# SR

SELLE ROYAL



## SELIM PVC TOY 20 COM CANOTE 7/8" 250MM - PRETO

Característica	Base em polipropileno extremamente resistente, espuma expandida e capa de PVC. Bicicletas Aro 12, 14, 16.
Material	PVC
Medida	0,081m <sup>3</sup>
Tamanho	236mmx243mmx145mm
Peso	397g
Embalagem	18 peças

20765



## SELIM SELLE ROYAL AMAZONAS PU COM MOLAS COM CARRINHO

Característica	Completamente fabricado em PU por injeção. Trilhos em aço. 2 molas acopladas ao trilho para absorção de impacto. Carrinho em aço zincado. Base em polipropileno extremamente resistente. Bike de passeio e urbanas   ciclistas que buscam conforto.
Material	PU
Medida	0,081m <sup>3</sup>
Tamanho	268mmx58mmx161mm
Peso	660g
Embalagem	22 peças

20767



## SELIM SELLE ROYAL BARRA CIRCULAR PU COM MOLAS COM CARRINHO

Característica	Completamente fabricado em PU por injeção. Trilhos em aço. 2 molas acopladas ao trilho para absorção de impacto. Carrinho em aço zincado. Base em polipropileno extremamente resistente. Bike de passeio e urbanas   ciclistas que buscam conforto.
Material	PU
Medida	0,081m <sup>3</sup>
Tamanho	273mmx72mmx237mm
Peso	748g
Embalagem	15 peças

20769

FOTOS MERAMENTE ILUSTRATIVAS. AS INFORMAÇÕES/CONFIGURAÇÕES DE PRODUTOS PODERÃO SOFRER ALTERAÇÕES SEM AVISO PRÉVIO.

ENTRE EM CONTATO COM O SEU CONSULTOR OU FALE COM O NOSSO TIME DE TELEVENDAS PELO (33) 3277-3030.



SELLE ROYAL



### SELIM SELLE ROYAL BEACH BIKE PU COM MOLAS COM CARRINHO

Característica	Completamente fabricado em PU por injeção. Trilhos em aço. 2 molas acopladas ao trilho para absorção de impacto. Carrinho em aço zincado. Base em polipropileno extremamente resistente. Bike de passeio e urbanas   ciclistas que buscam conforto.
Material	PU
Medida	0,081m <sup>3</sup>
Tamanho	260mmx37mmx261mm
Peso	677,75g
Embalagem	18 peças

20770



### SELIM SELLE ROYAL BRISA/TROPICAL PU COM CARRINHO

Característica	Completamente fabricado em PU por injeção. Trilhos em aço. Carrinho em aço zincado. Base em polipropileno extremamente resistente. Bikes infantis.
Material	PU
Medida	0,081m <sup>3</sup>
Tamanho	250mmx63mmx195mm
Peso	347,7g
Embalagem	26 peças

20771



### SELIM SELLE ROYAL CITY BIKE PU COM MOLAS COM CARRINHO

Característica	Completamente fabricado em PU por injeção. Trilhos em aço. 2 molas acopladas ao trilho para absorção de impacto. Carrinho em aço zincado. Base em polipropileno extremamente resistente. Bike de passeio e urbanas   ciclistas que buscam conforto.
Material	PU
Medida	0,081m <sup>3</sup>
Tamanho	254mmx46mmx212mm
Peso	645,15g
Embalagem	20 peças

20772

FOTOS MERAMENTE ILUSTRATIVAS. AS INFORMAÇÕES/CONFIGURAÇÕES DE PRODUTOS PODERÃO SOFRER ALTERAÇÕES SEM AVISO PRÉVIO.

ENTRE EM CONTATO COM O SEU CONSULTOR OU FALE COM O NOSSO TIME DE TELEVENDAS PELO (33) 3277-3030.



# SR

## SELLE ROYAL



### SELIM SELLE ROYAL HOLY RVS PRETO SEM CARRINHO

**Característica** Base em polipropileno extremamente resistente, espuma expandida e capa de laminado de PVC. Trilhos em aço. Canal ergonômico central que proporciona uma melhor ventilação e um melhor alívio de pressão nos tecidos sensíveis na área perineal e prostática. Versatilidade que permite adaptar-se facilmente de uma pedalada urbana até uma prática esportiva quer seja no Ciclismo de estrada ou Mountain Bike. Sistema patenteado chamado ICS-Integrated Clip System na parte de trás do selim para um fácil encaixe do pisca ou bolsinha de selim. Trilho com marcações milimetradas para ajudar no ajuste do bike fit. Espuma injetada através da tecnologia exclusiva de injeção Royal Vacuum System que faz com que o selim seja resistente a intempéries e tenha uma duração e qualidade por muito mais tempo.

**Material** RVS  
**Medida** 0,081m<sup>3</sup>  
**Tamanho** 260mmx56mmx157mm  
**Peso** 361,27g  
**Embalagem** 28 peças

20777



### SELIM SELLE ROYAL JUNIOR PU COM CANOTE 190MM

**Característica** Completamente fabricado em PU por injeção. Base em polipropileno extremamente resistente. Bikes infantis.

**Material** PU  
**Medida** 0,081m<sup>3</sup>  
**Tamanho** 234mmx185mmx127mm  
**Peso** 246g  
**Embalagem** 24 peças

20778



### SELIM SELLE COM CARRINHO

**Característica** Completamente fabricado em PU por injeção. Trilhos em aço. Carrinho em aço zincado. Base em polipropileno extremamente resistente. Bikes infantis.

**Material** PU  
**Medida** 0,081m<sup>3</sup>  
**Tamanho** 221mmx54mmx146mm  
**Peso** 276g  
**Embalagem** 54 peças

20779

FOTOS MERAMENTE ILUSTRATIVAS. AS INFORMAÇÕES/CONFIGURAÇÕES DE PRODUTOS PODERÃO SOFRER ALTERAÇÕES SEM AVISO PRÉVIO.

ENTRE EM CONTATO COM O SEU CONSULTOR OU FALE COM O NOSSO TIME DE TELEVENDAS PELO (33) 3277-3030.

# SR

SELLE ROYAL



1.



2.



3.

## SELIM SELLE ROYAL MOLISE RVS COM CARRINHO

Característica	Base em polipropileno extremamente resistente, espuma expandida e capa de laminado de PVC. Bike de passeio e urbanas   ciclistas que buscam conforto. Sistema de encaixe para bolsas ou luz. Trilhos em aço. Carrinho em aço zincado.
Material	RVS
Medida	0,081m³
Tamanho	252mmx81mmx204mm
Peso	579g
Embalagem	20 peças

1. 20780

2. 20781

3. 20782

FOTOS MERAMENTE ILUSTRATIVAS. AS INFORMAÇÕES/CONFIGURAÇÕES DE PRODUTOS PODERÃO SOFRER ALTERAÇÕES SEM AVISO PRÉVIO.

ENTRE EM CONTATO COM O SEU CONSULTOR OU FALE COM O NOSSO TIME DE TELEVENDAS PELO (33) 3277-3030.

# SR

SELLE ROYAL



## SELIM SELLE ROYAL SOFT FIT PU COM MOLAS COM CARRINHO

Característica	Completamente fabricado em PU por injeção. Trilhos em aço. 2 molas acopladas ao trilho para absorção de impacto. Carrinho em aço zincado. Base em polipropileno extremamente resistente. Bike de passeio e urbanas   ciclistas que buscam conforto.
Material	PU
Medida	0,081m <sup>3</sup>
Tamanho	267mmx62mmx180mm
Peso	701g
Embalagem	22 peças

20785



## SELIM SELLE ROYAL SOFT FIT PU SEM MOLAS COM CARRINHO

Característica	Completamente fabricado em PU por injeção. Trilhos em aço. Carrinho em aço zincado. Base em polipropileno extremamente resistente. Bikes infantis.
Material	PU
Medida	0,081m <sup>3</sup>
Tamanho	267mmx62mmx180mm
Peso	546g
Embalagem	20 peças

20786



## SELIM SELLE ROYAL VERSATILE RVS PRETO COM CARRINHO

Característica	Completamente fabricado em PU por injeção. Trilhos em aço. Carrinho em aço zincado. Base em polipropileno extremamente resistente. Bikes infantis.
Material	RVS
Medida	0,081m <sup>3</sup>
Tamanho	278mmx60mmx159mm
Peso	497g
Embalagem	22 peças

20787

FOTOS MERAMENTE ILUSTRATIVAS. AS INFORMAÇÕES/CONFIGURAÇÕES DE PRODUTOS PODERÃO SOFRER ALTERAÇÕES SEM AVISO PRÉVIO.

ENTRE EM CONTATO COM O SEU CONSULTOR OU FALE COM O NOSSO TIME DE TELEVENDAS PELO (33) 3277-3030.



SELLE ROYAL



### SELIM SPYDER RVS PRETO COM CARRINHO

**Característica** Base em polipropileno extremamente resistente, espuma expandida e capa de laminado de PVC Bicicletas aro 20 e 24. Trilhos em aço. Carrinho em aço zincado.

**Material** RVS  
**Medida** 0,081m<sup>3</sup>  
**Tamanho** 229mmx53mmx147mm  
**Peso** 413,72g  
**Embalagem** 32 peças

20788



### SELIM TROPICAL/BRISA BASE PLÁSTICA COM CARRINHO - PRETO

**Característica** Base em polipropileno extremamente resistente, espuma expandida e capa de laminado de PVC. Bike de passeio e urbanas | ciclistas que buscam conforto. Trilhos em aço. Carrinho em aço zincado.

**Material** RVS  
**Medida** 0,081m<sup>3</sup>  
**Tamanho** 250mmx63mmx209mm  
**Peso** 354g  
**Embalagem** 26 peças

20790



### SELIM VELOCE PU COM CARRINHO PRETO

**Característica** Completamente fabricado em PU por injeção. Trilhos em aço. Carrinho em aço zincado. Base em polipropileno extremamente resistente. Bikes A24 a A29.

**Material** PU  
**Medida** 0,081m<sup>3</sup>  
**Tamanho** 270mmx46mmx130mm  
**Peso** 419,50g  
**Embalagem** 32 peças

20792

FOTOS MERAMENTE ILUSTRATIVAS. AS INFORMAÇÕES/CONFIGURAÇÕES DE PRODUTOS PODERÃO SOFRER ALTERAÇÕES SEM AVISO PRÉVIO.

ENTRE EM CONTATO COM O SEU CONSULTOR OU FALE COM O NOSSO TIME DE TELEVENDAS PELO (33) 3277-3030.

# SR

SELLE ROYAL



### SELIM VELOCE RVS PRETO SEM CARRINHO VERNIZ PRETO

Característica	Base em polipropileno extremamente resistente, espuma expandida e capa de laminado de PVC. Bike de passeio e urbanas   ciclistas que buscam conforto. Trilhos em aço.
Material	RVS
Medida	0,044m³
Tamanho	267mmx46mmx140mm
Peso	327,50g
Embalagem	20 peças

20794



### SELIM SELLE ROYAL MTB PREMIUM PU SEM MOLAS COM CARRINHO PT

Característica	Completamente fabricado em PU por injeção. Trilhos em aço. Carrinho em aço zincado. Base em polipropileno extremamente resistente. Bikes infantis.
Material	PU
Medida	0,081m³
Tamanho	285mmx-mmx174mm
Peso	526g
Embalagem	24 peças

20783



### SELIM SELLE ROYAL MTB SPORT PU COM CARRINHO

Característica	Completamente fabricado em PU por injeção. Trilhos em aço. Carrinho em aço zincado. Base em polipropileno extremamente resistente. Bikes infantis.
Material	PU
Medida	0,081m³
Tamanho	255mmx65mmx170mm
Peso	347,85g
Embalagem	30 peças

20784

FOTOS MERAMENTE ILUSTRATIVAS. AS INFORMAÇÕES/CONFIGURAÇÕES DE PRODUTOS PODERÃO SOFRER ALTERAÇÕES SEM AVISO PRÉVIO.

ENTRE EM CONTATO COM O SEU CONSULTOR OU FALE COM O NOSSO TIME DE TELEVENDAS PELO (33) 3277-3030.

C A T Á L O G O

**KMC**

C O R R E N T E S



## Corrente Z9 – KMC

Característica	1/2"x11/128" 116L
Conector	Missing Link 9R/ CL566R
Compatível	Todos os sistemas de transmissão de 9 velocidades
Peso	286g
Embalagem	25 peças

11074



### SUGESTÃO MISSINGLINK

KMC 9 velocidades 11075



### SUGESTÃO FERRAMENTA

RAVA Alicates para  
corrente 13187



## Corrente Z8.1 – KMC

Característica	1/2"x3/32" 116L
Conector	Missing Link 8R/ CL571R
Compatível	Todos os sistemas de transmissão de 8 velocidades
Peso	321 g
Embalagem	25 peças

11073



### SUGESTÃO FERRAMENTA

RAVA Alicates para  
corrente 13187



## Corrente Z7 – KMC

Característica	1/2"x3/32" 116L
Compatível	Todos os sistemas de transmissão de 7 velocidades
Peso	331 g
Embalagem	25 peças

11072



### SUGESTÃO FERRAMENTA

RAVA Alicates para  
corrente 13187



## Missing Link – KMC

Característica	Missing Link 12/CL552
Material	Aço
Compatível	Correntes 12 velocidades   KMC   Sram
Cor	Prateado
Embalagem	20 peças

11078 / 22706



## Missing Link – KMC

Característica	Missing Link 11R/CL555R
Material	Aço
Compatível	Correntes 11 velocidades   KMC   Shimano   Sram
Cor	Prateado
Embalagem	20 peças

11077



## Missing Link – KMC

Característica	Missing Link 10R/CL559R
Material	Aço
Compatível	correntes 10 velocidades   KMC   Shimano
Cor	Prateado
Embalagem	20 peças

11076



**KMC**



## Missing Link – KMC

Característica	MissingLink 9R/CL566R
Material	Aço
Compatível	Correntes 9 velocidades   KMC   Shimano   Sram
Cor	Prateado
Embalagem	20 peças

11075



## Corrente Corrida 116L 7v. INDEX HV500 GYBR KMC

Característica	1/2" x 3/32" 116L
Compatível	Todos os sistemas de transmissão 7 velocidades
Conector	Missing Link 7R/HV-500 GYBR
Peso	350 g
Embalagem	25 peças

17909



### SUGESTÃO FERRAMENTA

RAVA

alicate para  
corrente 13187





## CORRENTE CORRIDA 116L 7/8V | C8

Característica	1/2"x3/32" 116 L
Velocidade	7/8 velocidades
Compatibilidade	Shimano   Campagnolo   Sram
Peso	306 g
Embalagem	40 peças

15454



## CORRENTE CORRIDA 116L 10V | C10

CARACTERÍSTICA	1/2"x11/128" 116 L
VELOCIDADE	10 velocidades
COMPATIBILIDADE	Shimano   Campagnolo   Sram de 10 velocidades
PESO	272 g
EMBALAGEM	40 peças

15456/20505



## CORRENTE CORRIDA 116L 9V | C9

CARACTERÍSTICA	1/2"x11/128" 116 L
VELOCIDADE	9 velocidades
COMPATIBILIDADE	Shimano   Campagnolo   Sram de 9 velocidades
PESO	289 g
EMBALAGEM	40 peças

15455



FOTOS MERAMENTE ILUSTRATIVAS. AS INFORMAÇÕES/CONFIGURAÇÕES DE PRODUTOS PODERÃO SOFRER ALTERAÇÕES SEM AVISO PRÉVIO.

ENTRE EM CONTATO COM O SEU CONSULTOR OU FALE COM O NOSSO TIME DE TELEVENDAS PELO (33) 3277-3030.

## CORRENTE CORRIDA 116L 6V | C30

CARACTERÍSTICA	1/2"x 3/32" 116 L
VELOCIDADE	6 velocidades
COMPATIBILIDADE	Shimano   Campagnolo   Sram de 6 velocidades (Estrada)
PESO	310 g
EMBALAGEM	50 peças
	15453



## CORRENTE 114L | C410

CARACTERÍSTICA	1/2"x 1/8" 116 L
VELOCIDADE	Single Speed
COMPATIBILIDADE	Sistemas Single Speed
PESO	345 g
EMBALAGEM	50 peças
	15457



# WTB

## ARO ALUM PAREDE DUPLA 32F MOD 01 PT

### CARACTERÍSTICAS

- WTB KOM i30
- ACABAMENTO ANODIZADO
- LARGURA INTERNA 30MM
- TUBELESS READY
- ETRTO RIM SIZE 30-622MM
- 32 FUROS
- DISC BRAKE
- LARGURA DO PNEU 42MM – 72MM
- ERD 606MM

### MATERIAL

Alumínio

### PESO

650g

### EMBALAGEM

10 Unidades

24733



## ARO ALUM PAREDE DUPLA 32F MOD 05 PT

### CARACTERÍSTICAS

- WTB KOM i30
- ACABAMENTO FOSCO ANODIZADO
- LIGHT
- LARGURA INTERNA 30MM
- TUBELESS READY
- ETRTO RIM SIZE 30-622MM
- 32 FUROS
- DISC BRAKE
- LARGURA DO PNEU 42MM – 72MM
- ERD 606MM

### MATERIAL

Alumínio

### PESO

522g

### EMBALAGEM

10 Unidades

24734



# WTB

FOTOS MERAMENTE ILUSTRATIVAS. AS INFORMAÇÕES/CONFIGURAÇÕES DE PRODUTOS PODERÃO SOFRER ALTERAÇÕES SEM AVISO PRÉVIO.

ENTRE EM CONTATO COM O SEU CONSULTOR OU FALE COM O NOSSO TIME DE TELEVENDAS PELO (33) 3277-3030.

## ARO ALUM PAREDE DUPLA 32F MOD 02 PT

### CARACTERÍSTICAS

- WTB KOM TRAIL i35
- ACABAMENTO ANODIZADO
- LARGURA INTERNA 35MM
- TUBELESS READY
- ETRTO RIM SIZE 35-622MM
- 32 FUROS
- DISC BRAKE
- LARGURA DO PNEU 47MM – 72MM
- ERD 605MM

### MATERIAL

Alumínio

### PESO

618g

### EMBALAGEM

10 Unidades

24735



## ARO ALUM PAREDE DUPLA 28F MOD 03 PT

### CARACTERÍSTICAS

- WTB KOM i30
- ACABAMENTO FOSCO ANODIZADO
- COM ILHÓS
- LARGURA INTERNA 30MM
- TUBELESS READY
- ETRTO RIM SIZE 30-622MM
- 28 FUROS
- DISC BRAKE
- LARGURA DO PNEU 42MM – 72MM
- ERD 606MM

### MATERIAL

Alumínio

### PESO

570g

### EMBALAGEM

10 Unidades

24736



FOTOS MERAMENTE ILUSTRATIVAS. AS INFORMAÇÕES/CONFIGURAÇÕES DE PRODUTOS PODERÃO SOFRER ALTERAÇÕES SEM AVISO PRÉVIO.

ENTRE EM CONTATO COM O SEU CONSULTOR OU FALE COM O NOSSO TIME DE TELEVENDAS PELO (33) 3277-3030.

WTB

## ARO ALUM PAREDE DUPLA 32F MOD 04 PT

### CARACTERÍSTICAS

- WTB i23
- ACABAMENTO ANODIZADO
- LARGURA INTERNA 23MM
- TUBELESS READY
- ETRTO RIM SIZE 23-622MM
- 32 FUIROS
- DISC BRAKE
- LARGURA DO PNEU 25MM – 65MM
- DIÂMETRO 29" / 700C
- ERD 606MM

### MATERIAL

Alumínio

### PESO

554g

### EMBALAGEM

10 Unidades

24737



## KIT RODA DIANTEIRA/TRASEIRA ARO 29" X 32F MODELO 01 BOOST PT

### ARO

WTB Kom Trail i35| 35 mm interno  
Alumínio| ETRTO Rim Size 35 - 622 mm  
Tubeless ready | 32 Furos  
Largura recomendada da seção do pneu  
47mm - 72mm (mínima x máxima) |  
Acompanha Fita de proteção de câmara  
WTB

### RAIO

Sapin | Inox 2.0mm  
Niple Sapin 14 mm x 2.0mm

### CUBO DIANTEIRO

Shimano MT400B | Boost  
Eixo de 15 mm | OLD 110 mm | 32 furos

### CUBO TRASEIRO:

Shimano MT 410 |Boost  
OLD 148 mm | Eixo de 12 mm  
32 furos | Free Hub Micro-Spline

### PESO

Dianteira 1070 gr / 1316 gr - 2386 (par)

### EMBALAGEM

1 peça

17810



29"  
WHEELS

FOTOS MERAMENTE ILUSTRATIVAS. AS INFORMAÇÕES/CONFIGURAÇÕES DE PRODUTOS PODERÃO SOFRER ALTERAÇÕES SEM AVISO PRÉVIO.

ENTRE EM CONTATO COM O SEU CONSULTOR OU FALE COM O NOSSO TIME DE TELEVENDAS PELO (33) 3277-3030.

## KIT RODA DIANTEIRA/TRASEIRA ARO 700C X 32F PT

**ARO** WTB Kom i23 | 23 mm interno | Alumínio ETRTO Rim Size 23 - 622 mm | Tubeless ready | 32 Furos | Largura recomendada da seção do pneu 30 mm - 64mm (mínima x máxima) | 700C | Acompanha Fita de proteção de câmara WTB

**RAIO** Raio Comum | Preto 2.0mm | Niple 14 mm x 2.0mm

**CUBO DIANTEIRO** Shimano RM35 | Center-lock | 32 Furos Blocação | HB-RM35 | Corpo em Alumínio | Eixo e Blocação em Aço | Encaixe: Blocação Quick Release (tradicional) | Diâmetro do Eixo: 9mm Comprimento do Eixo (O.L.D): Dianteiro - 100mm | Rolamentos: Cone com Esferas | Ótima vedação contra impurezas, poeira e lama | Cor: Preto

**CUBO TRASEIRO** Shimano RM35 | Center-lock | 32 Furos Blocação | FH-RM35 | Corpo em Alumínio, Eixo e Blocação em Aço | Encaixe: Blocação Quick Release (tradicional) | Diâmetro do Eixo: 9mm | Comprimento do Eixo (O.L.D): Traseiro - 135mm | Rolamentos: Cone com Esferas | Cor: Preto

**PESO** 2362 gr (par) com a blocação

**EMBALAGEM** 1 peça

17809



**29"**  
WHEELS

**WTB**

## FITA PROTETORA DE ARO

<b>TAMANHO</b>	26"
<b>LARGURA</b>	11 mm
<b>ESPECIFICAÇÃO</b>	Fita de aro WTB de alta resistência com tecnologia SOLID STRIP, NÃO É FITA TUBELESS!
<b>AVISO DO FABRICANTE</b>	Leia o manual do usuário e compatibilidade: <ul style="list-style-type: none"><li>• Confira as orientações em WTB.COM antes da instalação e uso.</li><li>• Solid Strip (Tira Sólida) só é compatível com WTB TCS 2.0 e aro tipo tubo.</li></ul>
<b>PESO</b>	10 gr
<b>EMBALAGEM</b>	200 peças

24376



## FITA PROTETORA DE ARO

<b>TAMANHO</b>	29"
<b>LARGURA</b>	11 mm
<b>ESPECIFICAÇÃO</b>	Fita de aro WTB de alta resistência com tecnologia SOLID STRIP, NÃO É FITA TUBELESS!
<b>AVISO DO FABRICANTE</b>	Leia o manual do usuário e compatibilidade: <ul style="list-style-type: none"><li>• Confira as orientações em WTB.COM antes da instalação e uso.</li><li>• Solid Strip (Tira Sólida) só é compatível com WTB TCS 2.0 e aro tipo tubo.</li></ul>
<b>PESO</b>	10 gr
<b>EMBALAGEM</b>	200 peças

25148



**WTB**



# Athletica

## NUTRITION



# Go! Energy Now! | Gel

## Ingredientes

FORMULA GO! ENERGY NOW GEL [Maltodextrina, Palatinose™ (Isomaltulose), Cafeína, Beta-Alanina, Cloreto de Sódio, Citrato de Sódio, Óxido de Magnésio, Cloreto de Potássio], Água Purificada, Água de Coco, Acidulante Ácido Cítrico, Regulador de Acidez Ácido Fosfórico, Aromatizantes, Conservadores Sorbato de Potássio, Benzoato de Sódio e EDTA Dissódico, Corante Artificial Vermelho 40 e Edulcorante Sucralose.

“NÃO CONTÉM GLÚTEN.”

“ALÉRGICOS: PODE CONTER DERIVADOS DE SOJA.”

## Forma de Uso

1 sachê 15 minutos antes do treino  
1 sachê durante, a cada 45 minutos de treino

## Embalagem

10 sachês de 30 g cada



22572



22570



22571



Athletica  
NUTRITION



Suplemento alimentar líquido.

- FÓRMULA GO! ENERGY NOW GEL.
- Carboidratos, Sódio, Magnésio, Potássio e Água de Coco.
- Cafeína e Beta-Alanina.
- Pode auxiliar na diminuição da fadiga, no aumento do estado de alerta e na melhora da concentração, na capacidade de resistência e desempenho de exercícios físicos, no metabolismo energético e no equilíbrio de eletrólitos.

Ingerir 30 g (1 sachê) com água mineral, antes ou durante o exercício.

**Não contém Glúten; Lactose e Gorduras.**

Entre em contato com o seu consultor ou fale com o nosso time de televentas pelo (33) 3277-3030.

Fotos meramente ilustrativas. As informações/configurações de produtos poderão sofrer alterações sem aviso prévio.

# Go! Recovery | Gel

**Ingredientes**      FORMULA GO! RECOVERY GEL [Sacarose, Maltodextrina e Palatinose™ (Isomaltulose)], Água Purificada, Água de Coco, Cloreto de Sódio, Citrato de Sódio, Cloreto de Potássio, Óxido de Magnésio, Acidulante Ácido Cítrico, Regulador de Acidez Ácido Fosfórico, Aromatizantes, Conservadores Sorbato de Potássio, Benzoato de Sódio e EDTA Dissódico, Corante Artificial Vermelho 40.

“NÃO CONTÉM GLÚTEN.”  
“ALÉRGICOS: PODE CONTER DERIVADOS DE SOJA.”

**Forma de Uso**      1 sachê 15 minutos antes do treino  
1 sachê durante, a cada 45 minutos de treino

**Embalagem**      10 sachês de 30 g cada

**Athletica**  
NUTRITION

■ 22574



■ 22573



Suplemento alimentar líquido.

FÓRMULA GO! RECOVERY GEL.

Carboidratos, Sódio, Magnésio, Potássio e Água de Coco.

Pode auxiliar na capacidade de resistência e desempenho de exercícios físicos, no funcionamento muscular e neuromuscular, no metabolismo energético, e no equilíbrio de eletrólitos.

Ingerir 30 g (1 sachê) com água mineral, antes ou durante o exercício.

**Não contém Glúten; Lactose e Gorduras.**



## INFORMAÇÃO NUTRICIONAL

Porção de 30 g (1 sachê)

	Quantidade por porção	%VD
Valor Energético	76 kcal = 319 kJ	4%
Carboidratos	19 g	6%
Sódio	85 mg	4%
Potássio	80 mg	**
Magnésio	80 mg	31%

\*%VD - Valores diários com base em uma dieta de 2.000 kcal ou 8.400 kJ. Alguns valores diários podem ser maiores ou menores dependendo de suas necessidades energéticas. \*\*VD não estabelecido.

**INGREDIENTES:** FORMULA GO! RECOVERY GEL [Sacarose, Maltodextrina e Palatinose™ (Isomaltulose)], Água Purificada, Água de Coco, Cloreto de Sódio, Citrato de Sódio, Cloreto de Potássio, Óxido de Magnésio, Acidulante Ácido Cítrico, Regulador de Acidez Ácido Fosfórico, Aromatizantes, Conservadores Sorbato de Potássio, Benzoato de Sódio e EDTA Dissódico, Corante Artificial Vermelho 40. “NÃO CONTÉM GLÚTEN.”  
**ALÉRGICOS: PODE CONTER DERIVADOS DE SOJA.**

Entre em contato com o seu consultor ou fale com o nosso time de televentas pelo (33) 3277-3030.

Fotos meramente ilustrativas. As informações/configurações de produtos poderão sofrer alterações sem aviso prévio.

# Go! Energy Now! | Cápsulas

Ingredientes	Cafeína anidra (Teor de 99,5% de 1,3,7 trimetilxantina), Antiumectante Dióxido de Silício, Veículos Gelatina e Água Purificada e Corantes Artificiais Amarelo Crepúsculo, Amarelo Tartrazina, Azul Brilhante FCF, Ponceau, Azorubina e Dióxido de Titânio.  "NÃO CONTÉM GLÚTEN."
Forma de Uso	1 cápsula (350 mg) antes do treino ou conforme orientação de Nutricionista ou Médico
Embalagem	60 cápsulas



**Athletica**  
NUTRITION

■ 22575

Suplemento de cafeína para atletas.

- Cafeína Anidra.
- Energia rápida.
- Pode auxiliar no aumento do estado de alerta, na melhora da concentração, na capacidade de resistência e desempenho de exercícios físicos de resistência e no metabolismo energético

Ingerir 1 cápsula antes do treino, uma vez ao dia.

**Não contém Glúten; Lactose; Calorias; Gorduras e Sacarose.**



Entre em contato com o seu consultor ou fale com o nosso time de tele vendas pelo (33) 3277-3030.

Fotos meramente ilustrativas. As informações/configurações de produtos poderão sofrer alterações sem aviso prévio.

# Go! Isotonic Drink | Pó

**Ingredientes** FÓRMULA CARBO BLEND (Sacarose, Dextrose Desidratada, Maltodextrina e Frutose), Cloreto de Sódio, Citrato de Potássio, Aromatizante, Acidulante Ácido Cítrico, Edulcorante Artificial Acesulfame de Potássio, Corantes Artificiais Azul Brilhante FCF, Azul Indigotina, Bordeaux S e Corante Natural Caramelo.

"NÃO CONTÉM GLÚTEN."  
"ALÉRGICOS: PODE CONTER DERIVADOS DE LEITE E SOJA."

**Forma de Uso** 30 g (2 colheres de sopa) durante o treino

**Embalagem** 900 g



22576



22577



22578



Suplemento hidroeletrólítico para atletas.

- Fórmula CARBO BLEND, Sódio, Cloro e Potássio.
- Energia.
- Pode auxiliar na reidratação, no equilíbrio hidroeletrólítico e ácido-base, no funcionamento muscular e neuromuscular, no metabolismo energético e na melhora do desempenho muscular durante exercícios físicos de alta resistência.

Misturar 30 g (2 colheres de sopa) em 400 mL de água mineral.

Preparo econômico para equipes: misturar 900 g (todo o conteúdo) em 12 L de água mineral.

**Não contém Glúten; Lactose e Gorduras.**



Entre em contato com o seu consultor ou fale com o nosso time de tele vendas pelo (33) 3277-3030.

Fotos meramente ilustrativas. As informações/configurações de produtos poderão sofrer alterações sem aviso prévio.

# Go! Repor Salt | Cápsulas

**Ingredientes** Fórmula 4Tech Salts (Cloreto de Sódio, Fosfato de Sódio, Bicarbonato de Sódio e Citrato de Sódio), Cloreto de Potássio, Estearato de Magnésio, Antiumectantes Celulose Microcristalina e Dióxido de Silício, Cápsula Gelatinosa (Gelatina e Água Purificada).

“NÃO CONTÉM GLÚTEN.”

**Forma de Uso** Recomenda-se a ingestão da porção de 1,1 g (1 cápsula) com até 500 ml de água, a cada hora de treino. Não consumir mais de 2 cápsulas por hora de treino

**Embalagem** 30 cápsulas



Suplemento hidroeletrólítico para atletas.

- FÓRMULA 4TECH SALT.
- Fósforo, Magnésio, Potássio e Cloro.
- Pode auxiliar no equilíbrio hidroeletrólítico e ácido-base, no funcionamento muscular e neuromuscular, no metabolismo energético e na melhora do desempenho muscular durante exercícios físicos de alta resistência.

Ingerir 1 cápsula com 500 mL de água mineral a cada hora de treino. Não consumir mais de duas cápsulas por hora de treino.

**Não contém Glúten; Lactose; Sacarose; Calorias e Gordura.**

**Athletica**  
NUTRITION

22579

INFORMAÇÃO NUTRICIONAL		
Porção de 1,1 g (1 cápsula)		
	Quantidade por porção	%VD
Sódio	314 mg	13%
Fósforo	22 mg	3%
Magnésio	1,4 mg	1%
Potássio	26 mg	**
Cloro	428 mg	**

\*Não contém quantidades significativas de Valor Energético, Carboidratos, Proteínas, Gorduras Totais, Gorduras Saturadas, Gorduras Trans e Fibra Alimentar. \*\*%VD Valores diários com base em uma dieta de 2.000 kcal ou 8.400 kJ. Seus valores diários podem ser maiores ou menores dependendo de suas necessidades energéticas. \*\*VD não estabelecido.

**INGREDIENTES: FÓRMULA 4TECH SALTS** (Cloreto de Sódio, Fosfato de Sódio, Bicarbonato de Sódio e Citrato de Sódio), Cloreto de Potássio, Estearato de Magnésio, Antiumectante Dióxido de Silício e Cápsula Vegetal (Vegapip®) (Hidroxipropilmetilcelulose, Água e Corante Natural Coqueliz). **NÃO CONTÉM GLÚTEN.**

Entre em contato com o seu consultor ou fale com o nosso time de televendas pelo (33) 3277-3030.

Fotos meramente ilustrativas. As informações/configurações de produtos poderão sofrer alterações sem aviso prévio.

# Go! Cramp Block | Cápsulas

**Ingredientes** FÓRMULA CRAMP MINERALS: [Bicarbonato de Sódio, Fosfato de Cálcio Dibásico, Óxido de Magnésio e Citrato de Potássio], MIX DE VITAMINAS: [Vitamina C (Ácido Ascórbico), Vitamina E (Acetato), Vitamina B6 (Piridoxina HCl) e Niacina (Nicotinamida)], Antiumectantes Celulose Microcristalina e Estearato de Magnésio, Cápsula (Água Purificada, Gelatina, Corantes Artificiais Amarelo Crepúsculo, Amarelo de Quinoeína, Azul Brilhante FCF e Dióxido de Titânio).

“NÃO CONTÉM GLÚTEN.”

**Forma de Uso** 2 cápsulas pré-treino ou a cada hora de treino. Seguir a orientação de Nutricionista ou Médico. Não consumir mais de 2 cápsulas por hora de treino

**Embalagem** 60 cápsulas



22580

Athletica  
NUTRITION

INFORMAÇÃO NUTRICIONAL		
Porção de 1,2 g (2 cápsulas)		
	Quantidade por porção	%VD
Sódio	69 mg	3%
Cálcio	60 mg	6%
Magnésio	71 mg	27%
Potássio	100 mg	**
Vitamina C	45 mg	100%
Vitamina E	10 mg	100%
Niacina	16 mg	100%
Vitamina B6	1,3 mg	100%

**INGREDIENTES:** FÓRMULA CRAMP MINERAL: [Bicarbonato de Sódio, Fosfato de Cálcio Dibásico, Óxido de Magnésio e Citrato de Potássio], MIX DE VITAMINAS: [Vitamina C (Ácido Ascórbico), Vitamina E (Acetato), Vitamina B6 (Piridoxina HCl) e Niacina (Nicotinamida)], Antiumectantes Celulose Microcristalina e Estearato de Magnésio, Cápsula (Água Purificada, Gelatina, Corantes Artificiais Amarelo Crepúsculo, Amarelo de Quinoeína, Azul Brilhante FCF e Dióxido de Titânio). “NÃO CONTÉM GLÚTEN.”

Suplemento hidroeletrolítico para atletas.

- FÓRMULA CRAMP MINERALS e MIX VITAMINAS.
- Pode auxiliar na prevenção de câimbras.

Ingerir 2 cápsulas pré-treino ou a cada hora de treino. Não consumir mais de duas cápsulas por hora de treino.

**Não contém Glúten; Lactose; Sacarose; Calorias e**

Entre em contato com o seu consultor ou fale com o nosso time de televentas pelo (33) 3277-3030.

Fotos meramente ilustrativas. As informações/configurações de produtos poderão sofrer alterações sem aviso prévio.

# Go! Hydrate Sport+ | Pó

**Ingredientes** Cloreto de Sódio, Água de Coco Desidratada, Cloreto de Potássio, Aromatizantes, Antiumectantes Fosfato Tricálcico e Dióxido de Silício, Acidulante Ácido Cítrico e Edulcorante Sucralose.

“NÃO CONTÉM GLÚTEN.”  
ALÉRGICOS: PODE CONTER DERIVADOS DE SOJA.

**Forma de Uso** Misture 5,5g (1 stick) em 300 ml (1 copo) de água gelada, uma vez ao dia

**Embalagem** 20 sticks de 5,5g



**Athletica**  
NUTRITION

■ 22581



Suplemento alimentar de minerais em pó.

- Blend de Eletrólitos.
- Sódio, Potássio e Água de Coco.
- Pode auxiliar na hidratação, reposição de minerais perdidos na transpiração nos esporte, no equilíbrio hidroeletrólítico e ácido-base, no metabolismo energético e no funcionamento muscular e neuromuscular.

Misturar 5,5 g (1 stick) em 300 mL de água mineral, uma vez ao dia.

**Não contém Glúten; Lactose; Sacarose e Gorduras.**

INFORMAÇÃO NUTRICIONAL		
Porção de 5,5 g (1 stick)		
	Quantidade por porção	%NVD
Valor Energético	16 kcal = 67 kJ	3%
Carboidratos	3,9 g	7%
Sódio	350 mg	15%
Potássio	80 mg	**

Não contém quantidades significativas de Proteína, Gorduras Totais, Gorduras Saturadas, Gorduras Trans e Fibra Alimentar. %NVD baseado em uma dieta por pessoa de 2.000 kcal ou 8.400 kJ. Alguns valores diários podem ser maiores ou menores dependendo de sua necessidade energética. \*\*Não há estabelecido.

**INGREDIENTES:** Cloreto de Sódio, Água de Coco Desidratada, Cloreto de Potássio, Aromatizantes, Antiumectantes Fosfato Tricálcico e Dióxido de Silício, Acidulante Ácido Cítrico e Edulcorante Sucralose. “NÃO CONTÉM GLÚTEN.” ALÉRGICOS: PODE CONTER DERIVADOS DE SOJA.

Entre em contato com o seu consultor ou fale com o nosso time de televentas pelo (33) 3277-3030.

Fotos meramente ilustrativas. As informações/configurações de produtos poderão sofrer alterações sem aviso prévio.



# Go! Pedal Pro + Electrolytes | Cápsulas

## Ingredientes

Cloreto de Sódio, Cloreto de Potássio, Óxido de Magnésio, Bicarbonato de Sódio, Citrato de Sódio, L-Carnitina Tartarato, Bisglicinato de Magnésio, Cloridrato de Piridoxina, Coenzima Q10, Antieméticos Celulose Microcristalina, Estearato de Magnésio e Dióxido de Silício e Cápsula Gelatinosa (Gelatina e Água Purificada).

"NÃO CONTÉM GLÚTEN."

"ALÉRGICOS: PODE CONTER DERIVADOS DE SOJA."

## Forma de Uso

Ingerir 2 cápsulas com 500 ml de água

## Embalagem

90 cápsulas



Suplemento alimentar em cápsulas.

- Sódio, Potássio, Magnésio, Vitamina B6, Coenzima Q10 e Carnitina.
- Ciclismo.
- Pode auxiliar no equilíbrio hidroeletrólítico e ácido-base no funcionamento muscular e neuromuscular, no metabolismo energético e na melhora do desempenho muscular durante exercícios físicos de alta resistência.

Ingerir 2 cápsulas ao dia com 500 mL de água mineral.

**Não contém Glúten; Lactose; Sacarose; Calorias e Gorduras.**

**Athletica**  
NUTRITION

22582



### INFORMAÇÃO NUTRICIONAL

Porção de 1,7 g (2 cápsulas)

	Quantidade por porção	%VD*
Sódio	240 mg	17%
Potássio	100 mg	**
Magnésio	70 mg	23%
Vitamina B6	2,0 mg	154%
Coenzima Q10	0,50 mg	
L-Carnitina	10 mg	

\*%VD refere-se aos valores diários recomendados para adultos. \*\*%VD não estabelecido. \*%VD não estabelecido.

**INGREDIENTES:** Cloreto de Sódio, Cloreto de Potássio, Óxido de Magnésio, Bicarbonato de Sódio, Citrato de Sódio, L-Carnitina Tartarato, Bisglicinato de Magnésio, Cloridrato de Piridoxina, Coenzima Q10, Antieméticos, Celulose Microcristalina, Estearato de Magnésio e Dióxido de Silício e Cápsula gelatinosa (gelatina e Água Purificada). "NÃO CONTÉM GLÚTEN." ALÉRGICOS: PODE CONTER DERIVADOS DE SOJA.

Entre em contato com o seu consultor ou fale com o nosso time de televentas pelo (33) 3277-3030.

Fotos meramente ilustrativas. As informações/configurações de produtos poderão sofrer alterações sem aviso prévio.

# Go! Pedal Pro | Pó

**Ingredientes** FORMULA CARBO BLEND [Maltodextrina (17% dextrose), Sacarose e Palatinose (Isolmaltulose)], FORMULA ELECTROLYTES [Citrato de Sódio Di-Hidratado, Cloreto de Sódio, Cloreto de Potássio, Óxido de Magnésio, Bicarbonato de Sódio, L-Carnitina, Coenzima Q10], FORMULA BETA-HD (Beta-Alanina, Cafeína e Taurina), FORMULA AMINO FUSION [L-Leucina, L-Lisina, L-Valina, L-Fenilalanina, L-Isoleucina, L-Treonina, L-Metionina, L-Histidina, L-Triptofano, L-Arginina], Acidulante Ácido Cítrico, Aromatizante, Antiumectantes Fosfato Tricálcico e Dióxido de Silício e Edulcorante Sucralose.

“NÃO CONTÉM GLÚTEN.”  
 “ALÉRGICOS: PODE CONTER DERIVADOS DE SOJA.”

**Forma de Uso** 15 minutos antes do treino durante a cada 1 hora de treino

**Embalagem** 700 g



 22583

 22584

**Athletica**  
NUTRITION

INFORMAÇÃO NUTRICIONAL		
Porção de 35 g (1 dosador rasco)		
	Quantidade por porção	%VD
Valor Energético	120 kcal - 504 kJ	6%
Carboidratos	30 g	10%
Sódio	250 mg	10%
Potássio	83 mg	-
Magnésio	63 mg	24%
Coenzima Q10	0,90 mg	-
Cafeína	75 mg	-
Beta-Alanina	300 mg	-
Taurina	100 mg	-
Carnitina	10 mg	-
L-Leucina	430 mg	-
L-Isoleucina	270 mg	-
Valina	275 mg	-
Arginina	90 mg	-
Fenilalanina	263 mg	-
Treonina	158 mg	-
Metionina	106 mg	-
Triptofano	50 mg	-
Histidina	180 mg	-
Lisina	395 mg	-

Todos os valores são estimados e representam a média de 10 análises. Os valores reais podem variar ligeiramente. %VD: Valores diários recomendados com base em uma dieta de 2.000 kcal ou 8.400 kJ. Seus valores diários podem variar dependendo de sua frequência energética. \*\*%VD não estabelecidos.

**INGREDIENTES:** FORMULA CARBO BLEND (Maltodextrina (17% dextrose), Sacarose e Palatinose (Isolmaltulose)), FORMULA ELECTROLYTES (Citrato de Sódio Di-Hidratado, Cloreto de Sódio, Cloreto de Potássio, Óxido de Magnésio, Bicarbonato de Sódio, L-Carnitina, Coenzima Q10), FORMULA BETA-HD (Beta-Alanina, Cafeína e Taurina), FORMULA AMINO FUSION (L-Leucina, L-Lisina, L-Valina, L-Fenilalanina, L-Isoleucina, L-Treonina, L-Metionina, L-Histidina, L-Triptofano, L-Arginina), Acidulante Ácido Cítrico, Aromatizante, Antiumectantes Fosfato Tricálcico e Dióxido de Silício, Edulcorante Sucralose e Corante Artificial Amarelo Opaco (E110).

**"NÃO CONTÉM GLÚTEN." "ALÉRGICOS: PODE CONTER DERIVADOS DE SOJA."**



Suplemento alimentar em pó.

- Fórmulas CARBO BLEND, MIX ELECTROLYTES, BETA-HD e AMINO FUSION.
- Ciclismo.
- Pode auxiliar no metabolismo energético, na manutenção do equilíbrio hidroeletrolítico e ácido-base, no funcionamento muscular e neuromuscular, na diminuição da fadiga, no aumento do estado de alerta e melhora da concentração, além de beneficiar o desempenho muscular e aumentar a capacidade de resistência e desempenho antes do exercício físico de alta resistência.

Misturar 35 g (1 dosador) em 300 mL de água mineral, uma vez ao dia.

**Não contém Glúten; Lactose e Gorduras.**

Entre em contato com o seu consultor ou fale com o nosso time de televendas pelo (33) 3277-3030.

Fotos meramente ilustrativas. As informações/configurações de produtos poderão sofrer alterações sem aviso prévio.

# COMBO

## Athletica Nutrition

CÓD. 22688



**Athletica**  
NUTRITION

### CONTEÚDO DO COMBO

2	NOW GEL (GUARANÁ C/ AÇAÍ)
1	NOW GEL (LARANJA C/ ACEROLA)
1	NOW GEL (MORANGO C/ LIMÃO)
1	RECOVERY GEL (GUARANÁ C/ AÇAÍ)
1	RECOVERY GEL (MORANGO)



ACESSE NOSSO B2B E COMPRE PELO LINK ABAIXO:  
<http://www.makeb2bjpp.avisnet.com.br/login>

Entre em contato com o seu consultor ou fale com o nosso time de teleendas pelo (33) 3277-3030.

Fotos meramente ilustrativas. As informações/configurações de produtos poderão sofrer alterações sem aviso prévio.



GRUPO  
**JPP**

Avenida Industrial 312, Distrito Industrial  
Governador Valadares - Minas Gerais/Brasil

[bike@grujpp.com.br](mailto:bike@grujpp.com.br)

(33) 3277-3030

[www.grujpp.com.br](http://www.grujpp.com.br)





GIYO  
New Supply

**GIYO**



## BOMBA DE AR MANUAL ALUM. P/ SUSP

### CARACTERÍSTICA

- Bomba para suspensão
- Marca gijo
- Pressão máxima 300 psi/ 20.7 Bar
- Alumínio

### INFORMAÇÕES COMPLEMENTARES

- Válvula Schrader acoplada fácil com alavanca;
- Suspensão traseira 300-psi e suspensão dianteira;
- Sistema de borracha selado não-risco na cabeça da bomba;
- Base de calibre fundido;
- Mangueira giratória 360° projetada para fácil bombeamento;
- Punho macio de 2 tons.

### MATERIAL

Alumínio

### TAMANHO

Tamanho 25.5cm

### PESO

224g

### EMBALAGEM

10 unidades

### CÓDIGO

23584

FOTOS MERAMENTE ILUSTRATIVAS. AS INFORMAÇÕES/CONFIGURAÇÕES DE PRODUTOS PODERÃO SOFRER ALTERAÇÕES SEM AVISO PRÉVIO.

ENTRE EM CONTATO COM O SEU CONSULTOR OU FALE COM O NOSSO TIME DE TELEVENDAS PELO (33) 3277-3030.



## BOMBA DE AR MANUAL ALUM. MOD.01

### CARACTERÍSTICA

- Bomba para suspensão
- Marca giyo
- Pressão máxima 120 psi
- Alumínio

### INFORMAÇÕES COMPLEMENTARES

- Excelente acabamento
- Alça em t
- Compatível com válvula presta e americana
- Acompanha velcro e suporte de fixação para o quadro
- Modelo GP-92T

### MATERIAL

Alumínio

### PESO

186g

### EMBALAGEM

10 unidades

### CÓDIGO

23585

FOTOS MERAMENTE ILUSTRATIVAS. AS INFORMAÇÕES/CONFIGURAÇÕES DE PRODUTOS PODERÃO SOFRER ALTERAÇÕES SEM AVISO PRÉVIO.

ENTRE EM CONTATO COM O SEU CONSULTOR OU FALE COM O NOSSO TIME DE TELEVENDAS PELO (33) 3277-3030.

**GILO**



## BOMBA DE AR MANUAL ALUM. MOD.02

### CARACTERÍSTICA

- Bomba para suspensão
- Marca giyo
- Pressão máxima 120 psi
- Alumínio

### INFORMAÇÕES COMPLEMENTARES

- Excelente acabamento
- Alça em t
- Compatível com válvula presta e americana
- Acompanha velcro e suporte de fixação para o quadro
- Modelo GP-94C
- Manômetro

### MATERIAL

Alumínio

### PESO

178g

### EMBALAGEM

10 unidades

### CÓDIGO

23586





AVENIDA INDUSTRIAL 312, DISTRITO INDUSTRIAL  
GOVERNADOR VALADARES - MINAS GERAIS/BRASIL

BIKE@GRUPOJPP.COM.BR

(33) 3277-3030

WWW.GRUPOJPP.COM.BR



GRUPO  
**JPP**